

MATRIX II



BY VALDAMAR VALERIAN

M A T R I X I I

THE ABDUCTION AND MANIPULATION OF

HUMANS USING ADVANCED TECHNOLOGY

by

VALDAMAR VALERIAN



MATRIX II

**Third Edition Printing
With Added New Material**

By

**Leading Edge Research Group
P.O. Box 481-MU58
Yelm, Washington State
C.F. 98597 C.F.**

Copyright 1990, 1991 Valdamar Valerian

All Rights Reserved

**LEADING EDGE RESEARCH
P.O. Box 481-MU58
Yelm, Washington State
C.F. 98597 C.F.**



Oftentimes have I heard you speak of one who commits a wrong as though he were not one of you, but a stranger unto you and an intruder upon your world.

But I say that even as the holy and the righteous cannot rise beyond the highest which is in each one of you,

So the wicked and the weak cannot fall lower than the lowest which is in you also.

And as a single leaf turns not yellow but with the silent knowledge of the whole tree,

So the wrong-doer cannot do wrong without the hidden will of you all.

Like a procession you walk together towards your god-self.

You are the way and the wayfarers.

And when one of you falls down he falls for those behind him, a caution against the stumbling stone.

Ay, and he falls for those ahead of him, who though faster and surer of foot, yet removed not the stumbling stone.

From "The Prophet" by Kahlil Gibran

D E D I C A T I O N

MATRIX II is the result of MATRIX plus 2 years of intense work. We feel that it is probably one of the most significant works that has ever been accomplished. The knowledge contained within it is a product of the blood, sweat and tears of many people. The abduction and manipulation of human beings by other species is a natural process that occurs when the awareness and intelligence of one species is less than another. It is the collective goal of many on this planet to raise the awareness and intelligence of the human species, as well as the awareness and intelligence of some alien species, to a point where unmanipulated evolving harmony can occur. The conflict, we feel, is based on energetic societal variants called "service to self" and "service to others". It is quite obvious that many species, including the majority of humans, do not realize the true possibilities that expanded awareness can bring. We have tried to balance the problem of polarities with in-depth discussions about states of mind that do not require polarities, which provides individual entities who read this material with an "out". Since the abduction of humans is a primary goal for some species, it is important that individual entities know the scope of what is happening to them and why. We have looked a lot deeper into what is happening with humans here, including alien mind sets and a construction of the societal structure and operation of some species. This information was obtained in the interest of all the species involved, and should be digested by all parties involved with this composite multidimensional scenario called "reality" .

This book is dedicated to all entities who are growing, learning, and teaching; to all entities that are the manipulators and the manipulated; to all entities that are "victims" and "participants" and to the continued evolvement of the Universal Intelligent Matrix that is generating all that they perceive. It is dedicated to those who view with judgement or non-judgement - so that they may understand each other.

Acknowledgments

We are indebted to all the researchers whose efforts and trials have provided us all with more understanding and knowledge of the drama unfolding around us. To all the researchers who have contributed material, we are deeply grateful. Hopefully, this effort will be a demonstration of how people can work together toward a common goal.

Special Acknowledgements

Special thanks go to Nexus Seven for allowing use of selections from his forthcoming book "TOP SECRET/APOTHEOSIS - A Multilateral Set of Hypotheses"; Lenny Lapon for "CHRONOLOGY OF PSYCHIATRY AND EUGENICS IN THE UNITED STATES AND GERMANY" from his excellent work entitled "MASS MURDERERS IN WHITE COATS"; Jason Bishop III for his long standing contributions of data and graphics; Cynthia Ozzimo for her contribution of special artwork ; Chan Johnson for his advice, patience, insight and fantastic graphics; Christa Tilton for her contribution of artwork, data and experience and sustained courage; Kristie Bjork for her frank discussions of her experience; Martti Koski and Robert Naeslund for their revealing expose on Canadian brain transmitters; John Lear for his courage and inspiration in the face of disbelief and hostility; Golden Retriever and CAC for their submissions on synthetics; Robert Lazar for his decision to go public about government owned alien disks; George Andrews and Barbara Bartholic for the story of Adrian from their forthcoming book "EXTRATERRESTRIAL FRIENDS AND FOES"; Cynthia Crowell for her revealing expose on the Government factor in abductions, her patience and knowledge; the members of Nevada Aerial Research Group worldwide for their input and support; the entities Bashar and Kirok, who have provided insight into higher level perception; and Robert Girard for his support and dissemination of vital information to the public.

The Material in MATRIX II is presented in the interests of research. All individuals are encouraged to research these materials on their own before arriving at definitive and final conclusions.

FOREWORD

In the last two years there have been many changes and developments. Research has taken a quantum leap, and a lot of really interesting information has come out. For a lot of researchers, the information presents a problem. A great many "researchers" foster extreme neglect on the populace by taking the stance of: "Well, I can't cope with these ideas and I can't prove them, so I'm not going to say anything to anyone and damage my credibility". We believe that attitude is contributing to the complacency that has been hallmark of the human population, and we think it is inappropriate.

We have never asked anyone to believe anything, and it is the position we take in MATRIX II. We simply believe that humans worldwide have a right to know what may be going on, and that they have the right to make up their minds for themselves, based on their own experience and that of others.

While "major" organizations are "doing their part", we feel that they are bound by their own self-defined limitations and cannot disseminate information on any kind of timely basis that would make any difference. They seem to be too concerned with their egos, the reactions of others, and themselves.

This will be the last MATRIX that will be published. We feel that we have done our part over the last three years in disseminating information and have injected sufficient material into the civilization to allow the process of investigation to continue. When data was first being released in 1987, very few would take any of this seriously. Now, people are jumping on the bandwagon and lecture circuit. A lot of people are approaching it in terms of "making money off the fears of others", just like the fire alarm salesman or the proprietor of a bar that supplies liquor to the depressed people who come in. We view this mental attitude as inappropriate. Many so-called hypno-therapists are seeking to "make a buck" off the situation that abductees find themselves in. This is also inappropriate. The abductees *do not* "need" hypno-therapy just because they are an abductee. Many abductees have come out of sessions wishing that the therapist could have a wire cage up their anus - it might change their attitude, they feel.

Over the last 20 years, we have accumulated information that suggests that the human population on this planet has been subject to intense manipulation by alien forces, and that the human population on Earth is considered by some species to be a slave-race, food source, and genetic pool. We feel that this is inappropriate, and that sentient beings have an innate right to evolve without manipulation. There is also a segment of the human population that composes the planetary power structure that is slave to negative forces and continues to foster a type of elitism that does not contribute to the development of the human species. The continuation of Master-Slave domination thought patterns that have been placed

on this planet is no longer appropriate - there are other ways to conduct a civilization. All of this awaits the eventual realization by all species that their existence is not dependent on any structure, and that cooperation promotes a positive differentiation that will promote evolvement. There are species who have the goal of conquering the physical universe (and other densities). They have much to learn, and will learn to co-exist with other species as they evolve. Very often, patterns that are perceived as being overtly negative are there to provide impetus to introduce the balancing factors that will encourage evolvement of all species concerned. There is a need for individuals of all species in physical densities to become more aware, for through development and growth of awareness comes the realization that all consciousness is part of the Universal Intelligent Matrix that underlies everything everywhere, and that thought patterns that depend on polarities are not necessary.

Humans on this planet have great potential. With the development and use of the "missing 90%" of the cerebral cortex, humans have the ability to do things that some alien species require technology to accomplish. That is one of the major reasons that humans are suppressed. Prior to or coincident with the development of mental abilities must also be the development of the "spiritual" abilities. Without these, there would be havoc with spiritually immature beings wielding abilities that would promote egotistical aims and results based on ignorance. This is also inappropriate.

What is needed is a break in the manipulative efforts of both the planetary power structures and the alien species involved. The development of awareness will aid the break in manipulation, and contribute to the evolution of humans and other species. It is part of this awareness to which we seek to contribute through this work.

In regard to research "in the field" - there is no such thing as an expert on UFOs or a person who is a "UFOlogist". Those terms promote continuation in a mind set that is not appropriate - one that perceives reality on a limited basis; it is one that boasts a pseudo-empirical attitude and offers a deluded "public" differing and continuous versions of the same system. It is this system which, encourages (by the structure of culture, language and programmed religious belief systems) maintenance of a mind set where entities (specifically humans) are encouraged to identify with their bodies, egos, material objects, etc., and to maintain a view of reality which is intentionally myopic. It is designed to limit awareness of the mass consciousness of the civilization by use of substances in the food and air, the condition of the electromagnetic atmosphere (which contains both general emanations from electrical equipment and specific emanations from devices designed to entrain and influence the human brain), and the promotion of a Master-Slave-Domination mind set (which causes division of the group into opposing camps of Elite and Non-Elite). It is the feeling among many that once this fallacy

is recognized, it will be realized that conscious promotion of this situation is no longer appropriate.

This, in fact, is the spirit in which the MATRIX series was written. It is meant simply to provide individuals who are predisposed to expanding awareness a chance to break away from the "wheel of fortune" and "take the pause that really refreshes".

It is the opinion of many that people are very deserving of the chance to do this, and all who oppose freedom of awareness, life, and evolution according to Service to Others should understand that their days of Elitism are short numbered. The move in this direction is a response to Elite actions over a long period of time - it cannot be brought to a halt. Elitism generates its own balancing and equalizing force - a force that is in tune with the development of awareness. When those who promote devolving reality systems finally have that realization that they are their own "worst enemies", and that consciousness by its very nature cannot seek anything but balance, then they will cease and desist and make the contribution to the general well being of all species and all lifeforms everywhere. This is by no means "idealism", for the very word indicates a myopic state of awareness. It is the way things operate best.

The disparity between what the public sees as "reality" and the true dimensions of reality is incredible. It is so incredible that built-in cultural blocks activate and many people decide to look the other way, because they basically feel that they have no other recourse when their reality structure is threatened. They have yet to understand that their existence is independent of any structure, and that manipulation of reality and perception is very often a matter of understanding some key facts, coupled with an effort toward expansion of their awareness - expansion according to a definitive act of will and a plan, not blindly.

Basically, the human population has been led blindly down a series of false paths, and has been manipulated by a series of nested conspiracies (a conspiracy is an action planned by a group on a covert basis). At the top of the stack of manipulative conspiracies you will find alien influence. In the middle you will find planetary power and control groups. At the bottom you will find the rest of the human population and the other lifeforms on the planet. It is the intent of the non-manipulative side of the coin to expose these factors, so that people will be given the chance to discover what is true for themselves. Someone has to provide this impetus - those Elite in power (both on the human and alien sides) will not provide this to you.

As a result of the suppression and compartmentalization of information, cultures have been fragmented into several distinct groups and mind sets which both co-exist and oppose each other.

Part of our culture does not or will not believe in the existence of other species; part of our culture acknowledges their existence or the probability of their existence; part of

our culture is actually interacting with those other species that are either alien to our planet or co-exist here with us.

During the last several years, some have sought to focus the attention of the public on documents (MJ-12, Aquarius, etc) or people (Moore/Shandera/Meier/Doty/Cooper/Lear, etc) instead of the real issues - the issues that affect humanity. The unwilling manipulation of human beings by government and alien forces is an issue that affects everyone - let's take a look at some of the evidence.

What constitutes evidence? In a society that encourages the use of empiricism as the only valid method of deduction, one would not expect much progress in a multidimensional universe, and that's exactly what we have - not much progress. The elements of corroboration, synchronicity, and sheer numbers also speak for themselves. The fact that there are reports of similar nature about similar subjects from widely varied sources planetwide in different cultures eliminates the element of collusion.

The major developments in "the field" over the last year or so have been precedental. No doubt, some of the information may be "disinformation" - it is certain that if we get it all out there to look at, it will provide the patterns and clues that are necessary to unravel the problem areas. To try to steer the thought patterns of researchers by classifying the information as "this or that" does them a disservice - it is essentially telling them that they aren't qualified to make decisions for themselves about the material. This is inappropriate.

With all this inappropriateness around, it would seem that the time is ripe to do something about it. We sincerely believe that the key to the whole resolution is awareness, both on human and non-human sides.

This book is compiled with materials from a wide variety of sources. It is also the result of many years of personal research for many people. Our personal research has unearthed really vital and interesting information. All this is presented here for your review. The book is assembled in such a way as to allow the reader to develop greater awareness as the book is studied. It is filled with information and concepts that every entity needs to be aware of - use it wisely - start discussion groups - grow together. Be at peace with one another and work together to help each other teach, learn, and grow.

Sincerely,



Val Valerian

TABLE OF CONTENTS

Description	Page
Aliens and the United States Government	1
Alien Contact; Facts and Considerations	6
Possible Alien Relationship to Earth Humans	7
Aliens Categorized by General Motivations	7
Government Duplicated Alien Spacecraft	7
The Primary Objectives of MJ-12	8
The Hypothetical MJ-12 Point of View	8
General MJ-12 Contact Axioms	9
Categories of Alien Interaction	9
There Appears to be Much Subtle Conditioning	10
Spiritually Evolved Human Aliens	10
Malevolent Alien Intent	11
Malevolent Aliens and Earth Religions	12
Stated Intentions of Benevolent Aliens	12
Dependence on Christian Adherence	13
Malevolent Alien Purpose and Strategy	14
In Your Reality the 'Predictions' May be Minimized	17
How will the Dire Predictions Not Occur?	17
What If We 'Buy' Malevolent Alien Manipulations?	18
The Malevolent Aliens May Be a Moot Point	19
The MJ-12 Controlled Information Release Predicament	19
Military Development of Anti-Alien Weapons	19
Economic Development of World Central Economy	19
Overcoming the Malevolent Alien Strategy	20
Media News in a Metered Fashion	20
Other Methods	21
Disinformation Objectives and Strategies	22
Conspiracies - Subjective Gestalt or Objective Reality	22
Organizational Security - Need to Know	23
Information Source/ Resource Control and Containment	24
Information Destination Control and Containment	24
Brainwashing Techniques and Psych Control Strategies	26
Deception Strategies of Alien Races	28
The Malevolent 'Soul-Processing' Hypothesis- Best Case.....	30
The Malevolent 'Soul-Processing' Hypothesis- Worst Case....	33
Grays as Neutral Aliens, Neither Good or Bad	40
Government Explanation of Previous Suppression	43
Possible Uses of Fear by the Secret Govt and Aliens	45
Alien Spiritual Deception Stratagem Revisited	47
Non-Interference Law Hypothesis	49
Exceptions to the General Non-Interference Law	50

MATRIX II

The Abduction and Manipulation of Humans Using Advanced Technology

<u>Description</u>	<u>Page</u>
THE GREYS, BLONDS AND OTHER SPECIES	
The Sirians and The U.S. Government: The M.P. Case	51-A
Variations Noted in Triangular Insignia	51-C
Orion Grey Type 1 and The Zeta Reticulan Greys	51-D
Orion Grey Type 2 and Orion Blond Humanoid	51-E
The Negative Greys - A General Overview	52
Negative Grey Objectives and Apparent Social Structure.	57
Negative Grey Strategies and Operations	58
Military Operations of Consciously Negative Aliens	59
Apparent Reasons for Orion Based Operations	60
Tentative Taxonomy of Extra-Terrestrial Humanoids	60-A-1
THE GRUDGE THIRTEEN REPORT	
Description and Analysis	62
Original Handwritten Analysis	71
WHO'S WHO OF ALIENS VISITING/LIVING ON EARTH	
Terrans	79
Extraterrestrial and Interdimensional	80
PRIMARY PHYSICAL CHARACTERISTICS OF THE GREYS	
General Physical Descriptions	81
Anatomical Details of EBE Hand	82
A Composite of Autopsy Findings	83
Reproductive Processes	84
Biological Materials and Animal Mutilations	84
CONCEPTS REGARDING SOME GREY SPECIES AS NEUTRAL/POSITIVE	
General Scenarios	84-D
Parallel Evolution As Reflected in Humans and Greys	84-E
Questions That Still Need Resolving	84-E
ELECTRONIC SPACE SOCIETIES: GREYS AND OTHERS	
Producing Hybrid Organisms	84-F
A General View of Electronic Space Societies	85
Crystalline Biological Structures	87
Light-Based Technologies	88
Appearance of the Reptilian Humanoid	88-A
More on Grey Anatomy and Organ Structures	88-B
Physiological Characteristics of Autopsied Species	88-C
RELATIONSHIPS BETWEEN NEGATIVE GREYS AND REPTILIANS89	
A Physiotype of a Grey-Reptilian Hybrid Entity	91
The Chroes Dialect of The Reticulan Species	91-A
The Gregg I/II Case and Other Examples of Alien Script .	91-C

The Abduction and Manipulation of Humans Using Advanced Technology

<u>Description</u>	<u>Page</u>
Targets of Observation	92
Devices on Reticulan Craft	92
Mind Control Substances	93
Teaching and Assimilation	93
Reticulan Objectives	93
Direct Observance & Inculcation	94
Density Levels and Greys	95

PASTURING AND USE OF SURFACE EARTH HUMANS

The Reptilians	96
The Greys	97
Command Progression of Influence	97
Other Species	98
Conflict for Control	98
Historical Background	98
Inner Earth Species Called Sasquatch	99
Underground Bases and Way Stations	100
The Yakima Indian Reservation	100
Additional Information About the Greys and Reptilians	100A
Entities from Alcyone System .(DWG)	101
Alien Species - Service to Self	102
Alien Species - Service to Others	104
The Bennowitz Studies of Three Alien Cultures & Greys	105A
The Project Beta Report	105F
AFOSI Documents Showing Events at Manzano WSA	105V
Documents Showing Government Surveillance of Bennowitz	105X

ABDUCTION BY ALIEN ENTITIES

Could It Happen to You?	106
Multiple Abductions and Multiple Witnesses	106
Contactees and Abductees	107
Blond Humanoid Contact	107
Blond Humanoids Generated by the Government	108
The Adrian Story	109
Other Contactees	114
What Happens?	114
Service to Self Scenarios	114
Service to Others Scenarios	115
Major Effects of Abduction	115
Memory Loss	116
General Manipulations of Humans	116
Beacon Abductees	116
Abduction by Greys	117
Bio-Field Differential	119
Using Tones to Interfere with Manipulation	119
Awareness Parameters for Tone Maintenance	119
Effects of Multiple Level Manipulation	120

The Abduction and Manipulation of Humans Using Advanced Technology

<u>Description</u>	<u>Page</u>
Bio-Conditioning of the Hybrid Fetus	121
Major Indicators of Alien Interaction	122
Abduction Related Medical Anomalies	123
Physical Locations of Abduction Injuries	124
Rare 1967 comic showing Abduction and Cloning	125
The Abduction of Christa Tilton	126
A Case Similar to Christa Tilton	127

THE GOVERNMENT FACTOR IN ABDUCTIONS

Government Knowledge of Abductions	129
An Early Experience	129
The Agent Handler Program	130
Government Implant Technology	130
Soul-Shearing	131
Letter from an Abductee	133
Channels as Contactees	134
Walk-ins	134
Awareness and Choice	136
Anonymous Letters Describes Alien Activity	137
Cow Blood Promising Stopgap in Humans	138
Abductee Training on Alien Equipment	139

POST ABDUCTION SYNDROME

Physical and Psychological Problems	140
Sleep Disorders, Sexual Components	141
Panic Type Disorders and Reactions	142
Obsessions, Inappropriate Actions	143
Avoidance Postures toward Children	144
Effect on Psychosexual Adjustment	144
Problems in Personal Relationships	145
Abduction Research - Approaches.....	146
Abductee Hybrid Breeding Categories are Apparent	146A
Exploring Memory Functions in the Abductee	147
Collection of Subtle Energies from the Abductee.....	148
Doorway Amnesia - Gateway to Other Dimensions	149
The Abduction of Human Children	150
Concepts of Overt and Covert Consent	152
Displacement of Consciousness Within Human Bodies	153
Multi-Level Involvement Scenarios	154
Human Actions That Have Halted Grey Activities	154
Individuals Immune to Grey Manipulation	155
Experienced Anomalous Trauma - A Questionable Mindset	156

The Abduction and Manipulation of Humans Using Advanced Technology

<u>Description</u>	<u>Page</u>
HUMAN MULTIDIMENSIONAL ANATOMY	
The Acupuncture Meridian System	157
The Chakras and the Nadis	159
The Astral Body	161
Higher Bodies	162
Frequency Models	162
Manipulations Involving Discrete Energies	163
Letter from Abductee Christa Tilton	165
Underground Alien Base Suspected in Washington State	167
Underground UFO Bases and Way Stations	168
Underground Tunnels Terminals and Branches	169
Letter from Abductee Kris Bjork	170
UNDERGROUND ALIEN AND JOINT USE FACILITIES FOR ALIEN REPRODUCTION, HUMANOID CLONING AND THE MANIPULATION AND CONTROL OF HUMAN BEINGS	
174	
Abductee Reports of Underground Facilities	176
US Gravity Anomaly Map	175
Mutes, Bases, Entrances, Vortices	178
Western US Tunnel Connections	179
Southern New Mexico	180
Sightings - Population vs Frequency	181
Civilian View of California	182
Military View of California	183
Major Underground Bases in the West	184
Mass Gravity Anomalies in the US	185
Areas of Caves and Caverns - US	186
Bases Reported Arizona & New Mexico	187
Event Characteristics of the Four Corners Area	187A
THE BASE NEAR DULCE, NEW MEXICO	
The Origin of the "Dulce Papers"	188
Dulce Papers Description	189
The "Dulce Papers"	190
Liquid Processing Vats and Cameras	190
Fluid Processing Bladders and Corridor	191
Symbol of Lyran Empire and Reticulans	191
Amniotic Sac Containing Alien Fetuses	192
Relative Size of Alien Fetus	192
Breeding Tub and Closeup of Alien Fetus	192
Cylindrical Breeding Chamber	193
Genetic Capabilities Made Public, 1965	194
Description of the Base at Dulce	195
Gray Sub-Species Abductor in Colorado, 1980	196
Genetic Diagram From Facility At Dulce	196

The Abduction and Manipulation of Humans Using Advanced Technology

Description	Page
Uniform of Security Personnel at Dulce	196
Coded Elevator Controls	196
Elevator and Door ID Card	196
Typical Entity Being Bred At Dulce	198
Conveyor System and Control Station	199
Overhead View, Hybrid Breeding Facility	199
Other Types of High Security Cards	199
Books of Seen on Craft and Underground	201
Appearance of Outside Security Guard Station	201
Manipulation of Christa Tilton on Craft	203
Detail of Vat Piping Arrangement	203
Three Types of EBE Seen by Abductee Tilton	204
Known Activities at Dulce Base	205
Alien Breeding Facilities	206
Alien Logo Symbols seen on Maps and on Equip.....	206
Typical Near-Surface Base Configuration	206
Underground Hybrid Care Facility	208
Serpent Symbols Seen on Alien Uniforms	209
Other Examples of Alien Symbols Seen	209
Mystery Object Found in Chromosomes, 1986	210
Crystalline Metal Diagram, Dulce	210
Cross Section of Deep Underground Facility	211
THE JUDY DORATY CASE	212
Cash-Landrum radiation suit against the US for injury	212A
Alien Technology Division	213A

GROOM LAKE, AREA 51 AND THE NEVADA TEST SITE

Air Force Seeks Restriction to Dreamland	214
Senator Harry Reid Letter on Area 51	216
House Subcommittee Testimony on Groom Lake Withdrawal	217
Public Hearing on Groom Lake Withdrawal: Nov 19, 1985	220
Public Hearing on Groom Lake Withdrawal: Nov 20, 1985	224
Radio Frequencies at Various Installations	230
Area near 29 1/2 mile marker, Rachel, Nevada	231
State Map of Nevada showing Groom Lake	232
Satellite Photo of Groom Lake	233
Topographic Map of Groom Lake	233
Configuration of Tunnels at Dreamland	234
Nevada US-Alien Facility Briefing	235
Scramble for ET Related Event, Las Vegas	236
Scramble Event Area	237

JOHN LEAR - COMPARISON OF POSITIONS AND INFO, 1988-1989

Statement of August 25, 1988	238
Interview on Radio, November 25, 1989	253
Criticism and Commentary on John Lear	275

MATRIX II

The Abduction and Manipulation of Humans Using Advanced Technology

<u>Description</u>	<u>Page</u>
Update on Current Events as of May 14, 1990: Lear	275-A
Scientist Robert Lazar and Dreamland/Area 51	276
Interview With Robert Lazar on Radio, November 1989 ...	280
Twenty-Nine Palms California Underground Facility	292
Pine Gap Australia Underground Facility	296
Underground Bases in Iran and Iraq	297
The War of the Caverns: Theory on UG Interface	298
Military Surveillance Technical Developments	300
The Story of Gary Stollman	303
MIND CONTROL AND MANIPULATION OF HUMAN BEINGS	
Mind Control Efforts in the United States	306
Operation Crystal Ball	308
Military Uses of the Electromagnetic Spectrum	308-A
Some Components of Mind Control	309
Social Reversal of Mind Control Rationale	310-A
Interview With A CIA Employee on Mind Control	310-B
Chronology of Eugenics in the U.S. and Germany	311
IMPLANT AND MIND CONTROL TECHNOLOGIES	
Implant Technology	320
Ridge Systems, Energy Centers and Auric Band Freq	323
Reichian Programming Device Used By Orions and U.S.....	324-A
Artificial Virtual Reality Generators and Use	324-B
Details On Reichian Programming and Devices	324-C
Electronic Mind Control Projects	324-D
The Real Scientific Electromagnetic Spectrum and ELF ..	324-E
Electrotechnological Planetary Applications	324-F
Abductees and Implant Devices	325
Cross-Section of Retrieved Spherical Implant Device....	325-A
UFORIC Project ID: Implant Detection	325-B
Alien Manipulation Networks	326
The Case of Robert Naesland.....	327-A
Lab Analysis of Naeslands Implanted Transmitter	327-H
Analysis of Implant Trigger Frequencies	327-I

The Abduction and Manipulation of Humans Using Advanced Technology

<u>Description</u>	<u>Page</u>
Inculcation Devices and Electronic Mind Manipulation	328
Learning, Teaching and Assimilation Techniques	328
Direct Observance Operational Procedures	328
Inculcation Devices	329
Rapid Inculcation Processes	329
Associative and Non-Cognitive Memory	331
CONVERSATION WITH AN ADVANCED SPECIES	332
Typical Human Grey Genetic Hybrid	334
Relationship, Connections and Generation of Entities	356
Conversations With The Essessani	357
Representative Image of the Essessani	357
Past Lives, Dimensionality and Personal Choice	364A
Definitions Helpful to Thought Processes and Expansion	365
Esoteric History - Some Notes	370
Theory of Longterm Planetary Management by Suppressives ...	370A
Evidence of Ancient Nuclear Explosion and Alien Mining	370D
Some Elements in Human History that Support Interaction with Non-Human Entities, Civilizations, and Technology	371
Psycho-Social Study of Human Conflict Reveals Alien Influence, Manipulation and Control	374A
An Esoteric Chronology	375
Theoretical Distribution of Cultures	377
Case Where Abductee Viewed and Aided His Own Clone	377A
REPLACEMENT OF HUMANS BY SYNTHETIC PEOPLE	
Discussion of Evidence	378
Discussion of Differences From Humans	378
Reports from Dr. Peter Beter	383
Genes Covering Growth in Humans	391
Reports from Others	392
Wave Forms Basis of Life Matrices	393A
Conversations on Synthetics and Clones	393B
Mutation Involving Chromosome Number Changes	393H
Mutants and Hybrids With Chromosome Changes	393J
Chromosomes and Species Alteration	393K
Example of Chromosomes and Characteristics	393M
Elite Life Extension - A Public Preview?	394

The Abduction and Manipulation of Humans Using Advanced Technology

<u>Description</u>	<u>Page</u>
Theoretical Functional Relationships In The Secret Govt ...	395
Planetary News Release in May 1990 About Planetoids & SDI .	395A
CHRONOLOGY OF HUMAN AND ALIEN INTERACTION AND COVERT INTELLIGENCE OPERATIONSRevised April 1990...	396
MASTER INDEX FOR MATRIX II.....	436

The Abduction and Manipulation of Humans Using Advanced Technology

Though stories about abduction of human beings by aliens are not new, they have only come to public attention in the last twenty years. By 1990 it is common knowledge that not only is abduction by alien entities real and legitimate, but it is a serious situation that must be understood if the general public, especially the abductee, is to come to terms with it.

Since the case of Betty and Barney Hill in the early 1960's, it has become apparent that there are alien entities that "need" humans for various reasons. The studies of Thomas Bullard¹, who reviewed more than 300 cases of abduction for a study funded by the Fund for UFO Research, indicate that there is a general scenario that occurs when people are abducted. This general scenario may include one or more phases where the individual is (1) Taken, (2) Examined, (3) Implanted with devices, (4) Communicated with, (5) Taken on a journey, (6) Subjected to psychic experiences, and (7) Returned to their point of origin.

Bullard had the following conclusions: human abductions are widespread in nature; people who are abducted represent a wide cross-section of society and are free of psychosis; they can be from any age bracket, but most are initially taken when they are fairly young; some cases feature spontaneous recall of the experience and include no memory blockage. Apparently, most abductees do experience memory blockage, especially with people who repeatedly undergo abduction. It may be in the interest of both the abductor and the abductee for the abductee not to remember what happens - the experience is, in many cases, very traumatic.

Aliens and The Government

Let's take a look at a little background history on aliens and the government:

In July 1947, the radar at the Four Corners area in the southwestern United States effected and took down an alien disk. It was entirely an accident. The disk landed near Roswell, New Mexico. It was to be the first of two disks that would crash in that area. On board, scientists and military personnel found several dead alien beings. An immediate analysis of their species could not be determined, but the aliens had both reptilian and insect-like qualities. Also on board were found the remains of several military personnel. As far as we know, this was the first major indication that human beings were being taken by an alien species. Within two years, the government would run into another case on the White Sands Missile

1: UFO ABDUCTIONS: The Measure of a Mystery" by Thomas Bullard,
Fund for UFO Research, 1987

Range where Sargeant John Louette would be abducted right in front of a witness by a disk that hauled him aboard with tentacle-like cables. His body was found three days later about ten miles from where he was taken. This is all described in the Grudge 13 report. (See Appendix)

Military and intelligence forces seized the Roswell disk and took it and the bodies to Los Alamos. It is estimated that the government has had in its possession at least 35 disks and 131 alien bodies over the last 45 years. They also have captured several live entities.

In 1949, another disk crashed, with one fatality and one living alien, whom they kept in a facility with an electromagnetic grid to ensure the isolation of the entity. The entity, whom MJ-12 member Detlev Bronk termed an EBE (Extra-terrestrial Biological Entity) and later ALF (Alien Life Form).

Since technological superiority also means superiority in military and intelligence circles, it was decided by the government that it would be to their advantage to communicate with the aliens and possibly acquire advanced technology. They also wanted to find out more about both the aliens and the role they were playing in mutilations and abductions of humans and animals.

In 1952, the government created several special agencies to help with the problem. The National Security Agency (NSA) was created especially to deal with the aliens. Together with the NSA and the CIA, the National Reconnaissance Office (NRO) and Delta Security forces completely took over all aspects of alien and disk interaction.

One of the projects created in 1952 was Project Sigma, which was a joint NSA/CIA project that had as its objective communication with alien species. The project was successful, and after communications sponsored through Project Plato (establish diplomatic relations), a meeting was held between elements of the US Government and the species known as the Greys on April 25, 1964 at 6pm at Holloman AFB. Two disks hovered above the runway while a third landed.

Thousands of feet of motion picture film were taken of the event, and in the 1980's, producer Linda Howe was contacted by Special Agent Doty of the AFOSI with a proposal to use some of the film in an HBO documentary. The government reversed its position later on, citing political reasons.

At the meeting at Holloman, a hostage was exchanged. The name of the US hostage is not known, but the alien hostage was known as Krlll (no vowels), who was confined to an electromagnetically secure facility near Los Alamos.

At one of the meetings between the government and the EBAN, as they called themselves, a treaty was negotiated. The government was aware that the EBAN had a part to play in both the mutilations and

the abductions, and probably hoped to find a way to eventually stem the tide of these activities. The EBAN told the government that their abductions of humans were for medical examination purposes. It wasn't until later that the government realized that the EBAN were lying to them.

The agreement was made, and contained some of the following provisions:

1. The United States would not reveal alien presence and would not interfere with alien operations.
2. The United States would allow the aliens to maintain underground bases. Old AEC underground facilities were some of the initial facilities to be offered, although larger facilities were built at 26 locations around the southwest.
3. The United States would allow the aliens to abduct its citizens on a periodic and limited basis for medical examination, providing that the people were returned unharmed and without memory of the interaction.
4. The aliens would furnish a periodic list of abductees. This list would be reviewed by the National Security Council.
5. The aliens would provide the United States with technology in beam weaponry, gravitational propulsion and mind control and implant technology. (Implant technology was in use as early as 1964 and legalized in Sweden by Olaf Palme)

It was estimated by scientists that the alien culture was at least 50,000 years ahead of ours. We even had our own scientists that were transferred to the alien world to study it. AFOSI Special Agent Doty: "We have research scientists studying their planet like they study ours".

Sometime after the government made the agreement with the aliens, they began to suspect that the aliens were abducting a larger number of people than reported to the NSC on the lists. The government wasn't so concerned about the animal mutilations, only the actions that involved humans. They also realized they had made an error in trusting the aliens and that they couldn't do anything about it - yet, anyway.

So, the aliens had violated the agreement. There was also an awareness in the government of what the aliens were really doing with the people they abducted. There was apparently little they could do but try and keep the information classified to prevent panic. In December 1988, former Navy intelligence officer William Cooper interviewed a man who said, " I don't know everything, but it's way out of control. To tell you the truth, I'm afraid of what's going to happen. Giant underground shelters are being built under Groom Lake and in other places."

At that time, in December 1988, there were other "leaks" that began to surface. It was said that the government tried to make contact with another group of aliens, allegedly the Reptilians (who are apparently advancing on this system), because they were one of the few enemies of the Greys who could get rid of them. The communication was done from the huge underground communications facility outside Datil, New Mexico in February of 1989. At the same time, at Los Alamos, scientists were phasing down the SDI program and continuing work on Project Excaliber, which involved nuclear missiles capable of penetrating 1000 meters of hard soil. They were equipped with a 1 megaton warhead, and were proposed for use on the underground EBE bases at Dulce, New Mexico, and others in the four corners area.

A new, more disturbing rumor began to surface. It said that the government had already developed an anti-matter weapon at Los Alamos National Laboratories, and would detonate it above the surface of the Earth, killing all life and destroying the atmosphere and water if the Reptilians would not help us get rid of the Greys. Evidently, other races use the Earth as a way station for natural materials and this was thought to be a good way to induce them to help us. There is no word on what the reply might have been.

The government decided to step up its public acclimation program, and the media began to feature more and more programs and concepts having to do with alien contact, trying to get the public prepared. It was thought by researchers that the government would stage its own controlled "UFO" landing in order to finally break the ice on the matter. Part of the acclimation program was the release of information simultaneously by the Soviet Union and the United States press about the landings in the Soviet Union that took place on September 27th, 1989. The use of the Soviet Union is apparently a tactic of MJ-12. Shortly after that, the radio talk shows in the western United States began buzzing with discussions of all facets of the alien problem.

There is no doubt that the government policy of secrecy makes the "harvests" easier for the Greys. Governments, by definition, are supposed to protect the public welfare. Obviously, something went very wrong here, and it appears that the Nazi SS intelligence-based CIA had a lot to do with it. One might note that alien related projects, such as those to test and fly captured alien disks and maintaining bases and "the other space program" require a lot of money. In 1949, there was virtually no heroin addiction in the United States. Lucky Luciano was allowed to return to Italy around that time to start up the heroin processing labs in return for his help to the government during the invasion of Italy during the war. Heroin began flowing into the United States in the 1950's, and it provided a good start for the massive addiction problem we have today. Bo Gritz, one of America's most decorated heroes, recently wrote a book called " A Nation Betrayed". In it he details that when he went over to South-east Asia to investigate the POW problem, he discovered that the

United States Government is the largest purchaser and distributor of heroin and cocaine in the world. Primarily, the CIA and the Delta security forces (sponsored by the National Reconnaissance Office at Fort Carson, Colorado) are involved. The process appears to serve two purposes: (1) To eliminate weaker elements of society and (2) To provide funds for alien-related and space projects.

In 1987, a Los Angeles police officer was killed when he discovered that the top floor of a hotel (name withheld) in Los Angeles was used as a CIA heroin/cocaine distribution point. Other points exist out of Riverton, Wyoming and on the Laguna Indian Reservation in Arizona. So much for the "Just Say No" program. Who was in charge of the CIA during the greatest increase in activity in these programs? . Wake up, planet Earth!

Dr. Carl Jung, famous psychologist, wrote a letter to Major Keyhoe one time about the UFO problem. In it, he said, " nothing helps rumors and panics more than ignorance. It is self-evident that the public ought to be told the truth". Even Abraham Lincoln had something to say about the American people and truth, " I am a firm believer in the people. If given the truth, they can be depended on to meet any national crisis. The great point is to bring them the real facts."

There is a lot more that is behind all these events, but we will cover some of that later. For more historical data, refer to the Chronology in the Appendix in the back of the book.

Alien Contact Facts and Considerations

1. Many major earth governments have secretly retrieved crashed examples of these aliens and their ships and it has over many decades produced a very secret high technology race to 'catch up' with the aliens who are already invisibly upon us.
2. After decades of development certain government military have 'caught up' in certain respects but not in others, but possibly enough to at the right time effectively convince the public that earth governments are still in 'control' of the planet.
3. The SDI program is ultimately a front for setting up a space defense system against alien forces (as well as against nuclear missiles from the 'reds'), or a way to disarm nuclear arsenals.
4. The Stealth program is a tiered front for both the public idea of the flying wing bomber but behind that there is a developed secret fleet of flying saucers or disks that duplicate certain types of alien technology rather closely (copied from crashed alien technology recovery operations), at least in general principle if not in actual technological means (to produce anti-gravity field effect propulsion systems). However, the government flying saucer development program existed long before the so-called 'Stealth' program ever existed.
5. The possible scenarios of official/unofficial, voluntary/involuntary open public view human-alien contact and scenarios for official/unofficial voluntary/involuntary secretive contact, combined with the factor of our own defensive flying saucer fleet are extremely numerous.
6. What triggers an open mass contact event depends on humanity and its threshold of readiness and realized ability to adapt and integrate to it. Maybe human civilization hasn't grown to the right point as a planet yet, or maybe hasn't gotten itself in a big enough nuclear or natural disaster 'pickle' yet.
7. The trigger for the release of the news that earth governments have saucers too, probably depends on what the aliens themselves do. At least it's the best shot that earth governments have in defending the earth from possible hostile aliens, or to match the aliens power - at least figuratively - to keep effective political and psychological hold on the populace if, for instance, a relatively friendly mass contact event and beginning of an interplanetary relationship occurs.
8. More remotely, the secret government fleet of saucers could be deployed to deceive the earth populace into a new global law and order government before the aliens themselves do - a sort of preemptive strike to establish unified global control - under a 'pretend we are aliens' scheme. However the aliens themselves are maybe waiting for earth governments to make this move and consider it a trigger for their own contact.

9. Or, more morbidly, some of the aliens are just coming to spectate and learn and to see if earth civilization destroys itself. Maybe it means something for the aliens to see earth get through the nuclear threat. Or maybe earth might be helping to secure or save the nearby alien civilizations in some way we don't yet fathom. What is at risk for the aliens in the goings on of earth?
10. Humanity can much more easily postulate all kinds of things that are at risk for humanity.
11. There is something 'spiritual' going on as well as 'extraterrestrial' that is going on and there is some tie in there.
12. The whole domain of alien-human contact is a massively fertile area for modern mythological development as far as both the common mainstream and fringe populace goes. That is at least until verified official mass contact occurs, then some myths will be shattered and a whole new crop will develop, and at that point it is probable that most of the world's establishments will be in psychological and economic upheaval.
13. Why are so many different types of aliens interested in earth? - Is it really crowded out there? Maybe it's not crowded, and something unique and important is happening, with possible effective consequences beyond our fragile shell of earth self interests, then that might explain it. However, it could be crowded out there and earth real estate is pretty valuable, or earth civilization is a very interesting, long term, cosmic biology experiment.
14. The aliens 'could' takeover if they wanted but they don't. That's not to say some aliens wouldn't want to use or inherit planet earth if they could. They may refrain from all too obvious contact for the most part - possibly out of respect for laws governing this space region and even this planet.
15. Some aliens are even extremely distantly related to some earth races. There is even some amount of alien-human interbreeding occurring even in recent times.
16. There are examples of aliens collecting flora, fauna, animal life and humans from the planet - both temporary and permanent abductions.
17. There are ongoing secret communications between certain aliens groups and an above top secret U. S. Government and consortium of world governments that exists to deal with the situation and keep the masses convinced it's not happening, yet.

18. Various different aliens and alien entities are involved in transmitting helpful information to certain receptive or conditioned humans, including advanced physics and high technology oriented data, data about nuclear dangers and reactors, medical informations and techniques, agricultural data, geological and natural disaster related data, architectural and living technologies data, earth historical and social data, current and predictive political data, commerce and economic data, and spiritual and religiously related data.

19. Some aliens are involved in transmitting damaging and hurtful information to certain humans, which is designed to deceive, manipulate, control, and further unknown and highly questionable alien objectives and motives.

20. In addition to government built flying saucers, the top governments of the world have developed means to objectively simulate/project 'UFO' phenomena by means of certain types of electromagnetic antenna broadcast technology, laser based technology, natural phenomena induction technologies, and have also developed means to cause controlled and uncontrolled mass subjective hallucinatory 'UFO' type experiences for groups of people by means of other kinds of electromagnetic and holographic broadcast technologies, chemical technologies, and so forth. All these means may be deployed to the advantage or disadvantage of the earth governments and power brokers in the event of mainstream verified alien mass contact.

7

Alliens Categorized by General Motivations

1. The Preventers - trying to help us from hurting ourselves or the earth up and helping to alleviate and reduce some of the problems we have created for ourselves - environmentally, geologically, etc
2. The Rescuers - here to harvest or help us if we have a big disaster we can't prevent
3. The Scavengers - here to pick up the salvage after we blow ourselves up - e.g. 'inheritors'
4. The Observers - here to spectate or learn or just look
5. The Experimenters - here to study some specific items, e.g. earth reproductive biology
6. The Invaders - here to do bad things to us if they can - e.g. enslave, control, manipulate, use us, invade
7. The Teacher/Friends - here to help us grow and eventually save ourselves and prepare for next steps in evolution

Government Duplicated Alien Spacecraft

Technology Public Appearance Triggers

1. Security leak out of control
2. World war III pre-emption strategy
3. Mass natural cataclysm - new government law and order strategy
4. Economic, political situation - new government control system installation that is earth situation triggered
5. Verified alien mass contact event - power equivalency showing
6. Alien contact impact pre-emption strategy
7. Government feels world is ready to accept and acclimate to anti-gravity technology

Possible Alien Relationship to Earth Humans

1. By proximity in galactic space - neighborhood story
2. By ancestral/current genetic ties - family story
3. By spiritual or social ties or similarities - some mutual interest - behavioral story
4. By local law in the universe - law story
5. By relatively random accident - chance story
6. By long distance exploration/explore - zoo story
7. By opposing or conflicting interests - enemy story

The Primary Objectives of MJ-12

1. Means to deal with isolated, reported, true sightings and contacts
2. Means to deal with individuals and organizations:
 - outsiders that penetrate security or obtain classified information via any means
 - insiders who knowingly breach security agreements and reveal classified information
 - anyone who unknowingly compromise security
 - outsiders who obtain physical evidence
 - outsiders who obtain photographic evidence
 - outsiders who maintain independent ongoing EBE contact
 - outsiders who act as contactee confidants or evidence relay or publicity agents or publishers
3. Means to deal with media - print, radio, TV
4. Means to subconsciously, subliminally, secretively, and covertly condition and prepare earth peoples and institutions and power centers for a mass contact event and it's aftermath
5. Means to deal with the immediate damage control, adaptation and acclimation to verified mass contact event when it happens - in every domain of human concern
6. Means to deal with the aftermath of verified mass contact to maintain and preserve valued status quo institutions and beliefs - in every domain of human concern
7. Means and ways of achieving an optimum advantage relationship with aliens in an long term ongoing earth-to-alien relationship - in every domain of human concern

The Hypothetical MJ-12 Point of View

1. There are many highly dynamical human system influences predictable for which open and speculative public-available knowledge should be made available - AND there are many important dynamical systems influences that are predictable that should be closed and secret from any serious consensus public-available knowledge - at least until a globally effective mass contact event does happen anyway and it is time to pull out the contingency plans.

Those things that better prepare all people and views in society for alien contact need more airtime, and yet certain drastic and bizarre implications of alien contact are better off largely not known by the seeing public as far as analysis can tell.
2. Certain knowledge will, by its sheer contrast and contradiction to accepted reality, cause momentous and fearful changes in many different foundational aspects of modern earth culture.

History indicates the risk for mass psychological panic and hysteria is extremely high if the populace has not been thoroughly prepared for such eventualities. Even with preparation, high levels of culture shock and systems breakdown could occur. All that can be done is to prepare to minimize and prevent the degree of damage at each point along the way.
3. History has shown that if there is a choice, it's better to debunk than to verify to minimize chances of cultural breakdowns. But in the case of verified mass contact this strategy is immediately changed to societal acclimation and control measures to reduce loss of status quo power.
4. When the single here-and-there contact and alien landing occurs the damage control is actually very easy with debunking, witness discrediting and the passage of time working best.
5. A widely verified mass contact creates the largest damage control problem in history. The strategy to minimize the expected severity of breakdowns is to implement a large set of preventative damage control measures before such an event actually occurs.

General MI-12 Mass Contact Axioms

1. That such mass contact could be either positive, neutral, or negative in nature in any number of spectrums of human (and even alien) reality
2. That the possibility of 'mass contact' could occur in a manner that is not entirely conscious and recognized on a mass level, in as much as contact could occur subconsciously, deceptively, marginally, non-actively or decenterally in relation to the human systems - politically, media-wise, religiously, economically, socially and so forth.
3. That the possibility of alien mass human contact on a central, conscious, multispectrum basis would result in a wide range of possible impacts on the existent and even cherished human systems, values and organized governing social, economic and religious bodies.
4. That the effective short and long term influence and change possible to earth human reality whether individually or socially conscious or not can be predicted sufficiently to permit conscious or subconscious earth human preparative action to prevent certain possible negative impacts. Negative impacts that such contact (conscious or subconscious, global or individual) may have on earth human existent systems and ways of life can be thereby reduced.
5. That humans - individually, socially and collectively - depending on the nature and system relative impact of contact, constructive or destructive in nature, will, in order to preserve operative aspects of who and what we are and have been, will find some form of accommodation of the implications such alien contact may have.

Categories of Alien Interaction

1. Involuntary no contact:
'bad' aliens in forced abidance by cosmic rules
- inactive
2. Voluntary no contact:
'good' or neutral aliens abiding cosmic rules
- inactive
3. Voluntary limited negative contact:
'bad' aliens only abiding certain rules
- minor active
4. Voluntary limited positive or neutral contact:
'good' or neutral aliens abiding by rules
- minor active
5. Voluntary unlimited negative contact:
'bad' aliens not abiding by rules at all
- major active
6. Voluntary unlimited positive or neutral contact:
'good' or indifferent aliens under special rules
- major active
7. Involuntary limited or unlimited, positive or negative contact:
'good', 'bad' or indifferent aliens accidentally breaking rules
- active

There Appears to be Much Subtle Conditioning

that has helped prepare earth people for certain aliens, however it is now clear the aliens that have made technology available to the secret government are not benevolent but are our enemies, as they do the abductions, lie, deceive, are generally malevolent, look like the aliens in the Close Encounters movie and in Strieber's 'Communion' book, and are apparently implementing a very carefully planned covert invasion which includes the brutal and inhumane use of humans and animals for advanced genetic experimentation and cross-breeding.

To complicate matters further, there are also aliens who appear somewhat similar to the 'grays' which are in league with the world's secret government, but in fact are supposedly benevolent and 'loving' beings. So it may be difficult to tell who is who.

Hopefully when there is open mass exposure of aliens to the earth populace, these cases of mistaken identity and intent will be kept to a minimum until the benevolent human aliens have communicated the truth of the situation.

The other aliens, who look quite human, state Earthkind is not ready for their advanced technology, need spiritual development, and request unilateral nuclear disarmament by all earth governments. They may be in fact benevolent or they may be malevolent in deep cover.

However, once again, to complicate matter even further, the malevolent 'grays' have in league with them certain quite human appearing aliens which one may mistake for being benevolent. And we can count on the 'grays' use of them to generate mistaken identity and confusion amongst people as to who to trust.

The Most Spiritually Evolved Physical Human Aliens

appear to be the ones that are from the Pleiades and who contacted Billy Meier in Switzerland over a period of many years. This is only concluded based on the depth of information contained in the unedited Meier contact notes. If any are the real McCoy and benevolent fundamentally relative to Earthkind and Earthkind's measures of benevolence it is probably the Meier related Aliens.

The other supposedly 'benevolent' aliens are also, by their own claims, connected with the Pleiadeans of the Billy Meier case, but are not apparently as high in evolutionary grade, yet are definitely by all surface appearances, yet positive and benevolent in nature, and are the ones under the command of a very tall human-like alien called 'Hatonn'.

This group or 'confederation' also includes another commander called 'Ashtar', and are apparently charged with possible earth human 'evacuation' in the event of an 'armageddon' situation developing on earth, as predicted in the Revelations of the new testament. This group also includes an individual by the name of 'Esu Immanuel Jesus Sananda', who claims to be the original 'Jesus' of the bible returning to lift up (off the planet) the faithful at various points along the 'tribulation' period as indicated in the Revelations of the bible. This lift off and this fellow Immanuel Jesus Sananda are clearly fitting into the biblical predictions, however, there are a few important items to note:

- a) 'Jesus Sananda' is apparently a flesh and blood physical humanoid alien, albeit apparently operating in a 'dimensional shift or two' beyond our 'dense' physical.
- b) 'Hatonn' is also flesh and blood being and is reportedly 9 feet tall. Definitely alien. They do not claim they are gods or angels, but also do not deny it either according to the popular 'channeled' or 'transmitted' information.
- c) This whole group may be part of a split off group from the original so called 'satanic' entities who were resident in underground bases on earth and were creating, manipulating and 'guiding' multiple religious histories for two thousand years (according to Meier notes).

They are not malevolent now, and it appears that indeed both Sananda and Hatonn themselves for that matter were NOT ever part of this group, however, they are definitely being assisted by ex-malevolents (now supposedly 'benevolent') Ashtar and his group. 'Ashtar', according to the 1975 Meier transcripts is the new name for an individual originally named 'Aruseak'. In fact the full name for Ashtar is 'Ashtar Sheran', and whom is cousin of 'Kamagol', the evil commander of the Earth underground based malevolent aliens.

Ashtar was in league with these malevolents until only 30 years ago, when he supposedly 'defected' from their ranks with a several thousand sized group of subleaders and others. The Meier Pleiadeans stated Ashtar and his group may have grown beyond their previous malevolence (seen the light) and have rejoined a long standing positive and benevolent 'galactic confederation'. They are tasked with assisting Hatonn and Immanuel Jesus Sananda in their expected 'capture' of 'light workers' on earth in the 'end times'. Its a mouthful. It's mixing tons of highly subjective religious issues and historical claims and predictions with the more nuts and bolts objective data studied.

There is a difficult to stomach mixing of scientific, religious, economic, psychic, new age and street talk metaphor going on here. It is a beyond-colossal conspiracy, if true.

The Meier case is a celebrated one which has encountered all-out malignment by many operatives, including Friedman, Andrus, Korff, Klass, Moore, Earley, etc. This is because certain of Meier's physical evidence was found to be 'doctored' and secondarily though may be because the actual unedited contact transcript notes contain the extremely damaging information, that is, complete disclosure of the intent and methods and dangers associated with the malevolent aliens and their strategy.

It is a strategy whereby the malevolent aliens are building an 'faustian' alliance with the secret government to enable them to effectively claim the earth for their own, with humanities unwitting consent, before any other aliens are able to effect appropriate contact within the constraints of so called 'universal laws' to which other alien races supposedly adhere.

It is the Malevolent Alien's Intent to Ally

earth peoples and governments to them so completely that humanity will unwittingly attempt to blame (and thereby reject) the 'benevolent' aliens for many many things, including AIDS, other plagues, elemental storms, earthquakes, and other disasters. These alleged alien actions will be explained as alien covert or overt earth invasion tactics, e.g. to reduce the population, disrupt normal commerce and life, and generally beat the earthlings down for subjugation and extinction (why? - maybe they want our nice planet all to themselves with us as their servants or slaves or food supply or...).

The information that answers all the remaining questions is so explosive that in the only English translation of the original Meier German language contact conversation transcripts that has been done, the editor (Wendell Stevens) has carefully and purposely excised all the most religiously and politically offending data, partly out of unconcealed disagreement with the data by the translators, and partly out of fearing for his life.

The actual original German notes also exist in transliterated English form which contain all the information, about sixty pages or so more, which represent the Pleiadian alien's carefully laid out indictment of the malevolent alien's intentions, history, evil doings, names, codewords and deeply rooted cultural and religious deception and control programs.

Anyone who will read the Stevens' massaged, edited translation are given a reprieve from being exposed to the actual point by point indictment. Unfortunately, even some of the positive spiritual information is also edited out.

The Meier contact transcript translators felt inadequate to deal with all the religious and spiritual related data and so kept their noses clean by only attending to scientific, technical, and 'gee whiz' information. Fortunately, diligent people can still get ahold of the original transliterations in English which are not edited.

The secret government contingency plans that exist to attempt to control or stop a potential runaway disclosure of these facts are in place. Contingency plans also exist to effect damage control of an actual runaway disclosure, and are directly threatening to freedom as we know and depend on it.

Treating #2. we are bogged with the prospect that any alien counter could uproot everything we as humanity hold to be sacred and stable. Under the surface however, the facts are far more shocking.

The Malevolent Aliens Say They Created Earth Religions and religious figures.

The 'benevolent' aliens claim that the malevolent aliens did not create the original figures in Christianity, Islam, Buddhism, Hinduism, etc. but DID create, manipulate, warp, and control earth subsequently organized religions, but not for the purposes the malevolent aliens state.

The 'malevolent' aliens have claimed their total authorship of the religions as a means to inculcate humanity's dependence and prospective allegiance to them and reverence of them. Their apparent behavior indicates an attempt to leverage that claimed authorship to their own benefit by placing themselves in the position of being 'gods' or 'god's divine messengers'.

The 'benevolent' Meier-related aliens make it exceedingly clear that the malevolent aliens created organized religions and controlled mass psychology for thousands of years, merely as a means for subjugating, controlling, manipulating and directing earth civilization's perceptions, concepts and behaviors.

The benevolent aliens (Pleiadians) state the aliens from Orion Betelgeuse and their Gizeh intelligences counterparts (the outpost control group) - also known as the Kamagol II group (Meier), are all effective allies in an very evil strategy to 'take' the earth for themselves. Some evidence supports the theory the malevolent aliens are using humanity as raw material for their effective rebirth as a thriving race - they claim to be from a dying planet and 'need' our help. Their intention actually is to subjugate and control humanity covertly, or otherwise overtly if necessary.

The Stated Intention of the 'Benevolent' Aliens

is only to observe, assist certain especially suited and compliant earth people to become 'prophets' regarding the whole problem, support earth independent free-will-based spiritual evolution, execute the 'evacuation' of earth peoples in certain circumstances, and help to prevent planetary and possible subsequent interplanetary disaster.

The primary mission of the few 'prophets', whom the most important one is Meier according to the benevolent Pleiadians who work with him, is fundamentally to reveal the facts regarding the deeply rooted mass delusion of most religions as a mass control strategy implemented by the malevolent aliens, reveal the malevolent strategy and tactics, and prepare earth peoples to be able to have a choice in the matter of what aliens they ally themselves to, and finally to proffer to humanity the true spiritual wisdom that can effectively counteract the delusory religions which have a virtually invincible grip upon the minds and hearts of most earth people.

Meier was chosen for this task because he apparently was in a position to be permitted to deal with these facts and this critical disclosure since he once himself in a previous life was one of the 'evil ones' himself and has since grown beyond that evil, is closely allied in friendship with the most positive and evolved aliens from the Pleiades, and wishes to make compassionate 'amends' for all of earth humanities sake, as well as for his own conscience.

Because of Meier's supposedly special relationship to earth's historical events, he was also tasked to bring forth the original, recently secretly discovered and retrieved (from the original burial place where Jmmanuel Pleiadians direct assistance) the scripts of Jmmanuel, who is falsely called Jesus Christ according to these Pleiadians.

The exposure of these now recently translated scripts of unadulterated truthful words of the man we apparently wrongly call Jesus Christ will hopefully be integral support for humanity to be able to break away from the iron grip of the malevolent alien derived false, delusory and highly modified teachings that currently compose the new testament of the bible. Hopefully Meier himself or his English language translators have not done any fudging of the material. One would expect not, since he himself is tasked with cleaning up the mess, not making yet another one.

The Malevolent Aliens are Depending on Christian Adherence

and allegiance to Revelations end-time predictions, since that falls directly into their hands to be able to effectively counteract the greatest danger to the malevolent aliens - the real truth being told and listened to by intelligent people who are not completely controlled by religious delusions and rampant cynicism.

However, there is some contradictory statements being made by these different 'positive' aliens. On one hand the Meier Pleiadians state that Jmmanuel is Jmmanuel, and NOT Jesus or Christ or God. They further state that even the very words 'Jesus', 'Christ', and 'God' all hide within them the number (666) and vibration of death, destruction, evil, and eradication of the truth, and claim that the original 'Jmmanuel' agrees with this conclusion.

On the other hand, the other non-Meier-related, self proclaimed 'Pleiadians' who are communicating through an individual named 'Dharma', are quite open and affirmative about calling this fellow 'Esu Immanuel Sananda Jesus' by the name of 'Jesus' and 'Christ' (but not 'God'). In fact they make full free use of these names.

There can only be one of two conclusions to this apparent contradiction (assuming the whole group is not cooked up in someone's imagination and are indeed, aliens):

a) The 'Hatonn' and 'Sananda' so-called Pleiadeans are clearly needful of having a recognizable reference point that can indicate to the 'truly faithful' that this fellow IS the right one, that is, their 'Jesus' of the 'second coming'. And so, they are stuck with the fact that these false names are the only stable and recognizable names for most earth people, regardless of the fact of the name's inherent 'evil' vibration (according to the Meier related Pleiadians). It is a case of making do with what they've got - the false names have become the only effective means to reference who is who.

b) Alternatively, and more frighteningly, the Meier Pleiadians are telling us the truth and that only the deceptive malevolent aliens would use these names, and that Hatonn and this Sananda character are wolves in sheep's clothing. Given the apparently very valuable quality and quantity of information coming through 'Dharma', this would be a horror, especially since Sananda and Hatonn seem in all surface evaluated respects to be the real McCoy 'benevolent' aliens, and are the 'leaders'.

The Meier Pleiadians also tell us that the Christian religion itself is the '666', spoken of in the Revelations, and that an individual who is the 'anti-christ' is NOT '666' and will attempt to unite the world in peace and there is ANOTHER fellow who will actually be the '666', extremely malevolent Christian person

Once again the plot thickens, and we have a confusion developing as to whether the 'anti-christ' is actually a 'good guy' trying to free Earthkind from 'Christian' religious slavery, or the 'anti-christ' is in fact the 'bad guy', and who may use Christianity as a deceptive deep cover for his 'works' or may not, depending on what provides the best cover.

The Malevolent Alien Purpose and Strategy

These allegedly good aliens are expecting we should all be Bible Revelations students and use the very unclear and cryptic and probably untrue biblical 'predictions' as the big 'truth' and 'timetable'. Most truly spiritually developed people would probably rather take the slow boat than have to sit next to some 'sing song', arrogant, self righteous, evangelical extremist on a Christian 'rapture' spaceship which may actually be a 'food or slave harvest' ship instead. This is not to say there are no beautiful, devout, and genuinely spiritually growing Christians in the world, nor that 'rapture' is malevolent.

Meier could be a keyperson in the ultimate positive resolution of historical falsehoods of religion, and has and is being helped by the Pleiadians in his task, and the Pleiadians are only permitted to help him precisely because of his supposed integral personal relationship to past historical religious deception.

Therefore, in the pro-Meier scenario, the worst enemy of the malevolent aliens and their strategy are the Pleiadians and Meier and others like him who can clearly comprehend and cope with the extremely unpleasant truth in a manner that is constructive and communication mass media successful.

The Pleiadians themselves are not able, by virtue of adherence to certain 'galactic laws' of 'restraint and non-interference' in developing planetary cultures, to effect mass contact unless the populace of earth clearly requested and was ready for it, thus only Meier and a few others are in the position to effect greatest damage to the malevolent alien strategy.

The malevolent aliens are actually the biological living and breathing devils and gargoyles of past history and myth, and possibly some of the angels and gods as well. There may also be malevolents who are human looking as well. These aliens have also constructed all the major 'positive' religions to control earth populace using an ostensibly 'positive' cover for their eventual return and re-assimilation into earth culture (or what's left of it) as 'divine beings' and in all respects 'superior overlords' with 'religious righteousness' and 'omnipotent highness'.

Have compassion and sorrow for the millions who have unthinkingly held onto particular party-line religious beliefs as their only stable reference point in life? 'Yes' if #b above is true, and 'No' if #a above is true. If yes, they are the ones who will unknowingly be manipulated the most in times to come if Meier or others like him fail to bring his message of truth to a successful completion.

One of the saving graces in this situation is the fact the now the actual Jmanuel original teachings and writings done while he was in physical form 2000 years ago, are now here and available to help re-orient to the real truth all the religious people who will find themselves without an oar in a boat in a storm. Christian humanity will be hard pressed to want to abandon the only thing that has kept them full of hope in life - that is - their relationship to a 'saviour' unless they can still have their "cup filled with wine from the same cellar".

The items in the 'Dharma' writings (1989) that support #a above being true, include that the fellow 'Immanuel Sananda' (Jesus) states he is NOT able to "do it for people", he is NOT their 'saviour' in the sense of being divine above the laws of creation itself. That is consistent with the Meier transcripts. Also included in the Dharma writings (1989) is the statements by Hatonn that honor Billy Meier and denounce his vocal detractors which claim he

was a hoax. Why would these 'Dharma' connected aliens support Meier if indeed his connected alien's statements clearly pull their plug? However, there unfortunately exists the grim possibility that these 'Dharma' connected aliens are such expert deceivers that they would purposely 'support' Meier to fool people into thinking that they are indeed the 'good guys'.

What a mess! What was once just an pseudo-objective discovery of alleged facts now has combined with the hall of mirrors associated with new age channeling, telepathy, and other extremely difficult to assess sources and methods, even by direct experience.

It may be that because the original Meier transcripts have not really come to any significant light of day in English speaking countries (due to never being published in English) and that the 'Dharma' related aliens had no practical choice (or were therefore not worried about it) but to continue the usage of the inherently flawed, 'negative' names of 'Jesus' and 'Christ' for purposes of effective identification. This possibility exonerates the Dharma connected alien folks, so long as the Meier transcripts continue to not see the light of day, which would cause great confusion for many because of the contradictions that would surface. However, it could be a great travesty to NOT publish the full Meier transcripts if indeed they are bona fide and the related aliens the most benevolent. If and when the Meier 'unsanitized' transcripts DO get widely published in English WITHOUT spurious fear driven and opinionated editing, then more people will have a very confusing situation on their hands.

With the malevolent aliens taking credit for the creation (overtly) and guided development (covertly) from underground bases for 2000 years - main base approximately 1000 feet directly below the Pyramid of Gizeh) of religion (according to Meier aliens), and the end times predictions being (or playing into) the malevolent aliens central psychological control strategy, it is no wonder that when faced by these claims, that our secret government was effectively stumped, confused, and fearful about what to do. It was

safer to choose the stance of being a 'defensive warrior' than that of being an 'open hearted adventurer' who fearlessly jumps in head first and does not 'need' weapons and defensive stances as their bread and butter of continued existence.

We cannot safely say yet as to whether the malevolent aliens do include 'Hatonn's' group and 'Sananda Jesus' and the 'Ashtars' of the skies as their covert allies. Is it possible that these folks are not in reality a counterforce at all to the really malevolent aliens (grays and big noses and Gizeh intelligences), but are in fact a malevolent force that began its covert operations as apparent 'positive and benevolent' agents almost 30 years ago when Ashtar's group 'splintered off' from the malevolent Kamagol underground group.

The 'Dharma' connected aliens may yet be found to be relatively positive and benevolent though, despite the sensibly derivable doubts to that effect detailed here. In that case, it may be concluded that 'Sananda' is indeed the (reincarnated) 'beloved Jmanuel' (aka the original Jesus of the Bible before given that name by Paul long after Jmanuel was gone). If that is the case, it can then be concluded that the Dharma related aliens are not in fact that 'alien' but are our positive and benevolent spiritual ancestors whom we had better damn well start paying very good attention to, now that they are here to physically 're-connect' with and 'assist' humanity in the so called end of millennia transition period.

There is another possible logical and evidential bases, though, which can undermine the credibility of the ones called 'Hatonn', 'Sananda', and 'Ashtar' (but again there is still another loophole to alleviate this doubt as well). These three are 'space brother' aliens who were intimately connected in the Richard Miller Solar Cross transcripts that were remotely popularized in the book called 'Star Wards', published by the Solar Cross group in 1979.

That group, especially Richard Miller, their key person, apparently 'disappeared' shortly

after 1981 when certain major horrific predictions regarding total earthquake devastation did not come to pass. The people remaining at the Solar Cross group headquarters in Middletown, California stated that Richard Miller had become involved in imprudent and 'evil' sexual activities and "ran away to avoid prosecution and the law".

The Solar Cross group may have been infiltrated by that point and Richard Miller got the hell out, and a secret government operative plant devised the sex story as a practical means of explaining Richard Miller's disappearance, while continuing to ostensibly maintain the group to ascertain the extent of their adherents and information.

Many People Sold Their Homes and Belongings

and left certain areas in California because of the earthquake predictions because of the Solar Cross predictions. The prediction was that it was an inevitable foregone conclusion that Lake Elsinore in southern California would drain into an underground magmatic cavern which would trigger a totally devastating earthquake at the end of January, beginning of February 1981. That did NOT happen.

Now the problem is not that the predictions did not happen, but that the predictions were so completely vehement and inflexible. It was stated as a foregone conclusion that the massive quake WOULD happen no matter what, but it did NOT happen in fact. Now, this year, 1989, through Dharma, Hatonn (who in the Solar Cross group days was not the earthquake prediction maker - that was a fellow by the name of 'Soltec'. Others in this grouping included Hatonn, Mon-ka, Lalur, Korton, Ashtar, Sutko, Katonia, etc) is making the very same doom and gloom predictions, albeit not the Lake Elsinore part, but definitely the part stating that California would soon be in rubble, sustaining a 10 point plus quake along the length of the San Andreas fault.

However, once again there exists a possible loophole (allowing them to be 'right' in a fashion), although a very dubious metaphysical and unprovable explanatory loophole. It is

possible that the predicted late January 1981 quake DID happen, but occurred in a 'split-off' reality (yes, the earth exists in several parallel timestream realities with different circumstances affecting each, by this notion), and we (that is you who are reading this) 'created' ourselves being in the reality 'set' where it did NOT happen.

Problem is, however, now the Dharma writings of 1989, (with Ashtar and Hatonn are key) are ALSO making similarly dire predictions which are "absolutely inevitable" (again). These predictions include all the standard biblical revelations type horrific 'doom and gloom' events.

The irony of all this is that the Star Wards book had some 'valuable' and 'sensible' spiritual and psychological information in its pages, and the Dharma writings seem at first thoughtful reading to also include similarly 'valuable' data for practical and applied use, spiritually, medically, etc.

At risk of being a wet blanket here, the Dharma writings are 'off the deep end' in that they proclaim an inevitable and very unpleasant confrontation occurring at 'armageddon' time between a very real Lucifer (Satan) and Immanuel (Jesus). The Dharma writings make statements of almost intolerable drama regarding the whole end-times timetable and all the death, destruction, pain, suffering and 'tribulation' that will occur. It is all stated as being very physical, violent, worldly, and NOT symbolic. These are doomsayers here working to use fear as a motivator to their cause, and ignoring and denying any other choice or possibility.

While, yes, the millennia 'transition' period, if actually there is any truth to it, could hold horrific and painful reality for many people, it is NOT NECESSARILY the case for all people here on earth.

What should normal thinking feeling humankind DO with this stuff? If it is correct (notwithstanding the failed predictions via the Solar cross in 1981) then we ought to all be 'running for the hills', preparing for

'Armageddon', buying survival supplies, building fallout shelters, and generally 'gnashing our teeth' while praying and putting our entire spiritual allegiance unto this Sananda fellow sitting around in quasi-military defensive compounds, afraid of the world, and expect a great 'brethren beam me up' 'rapture' period to occur if we are really 'loving', 'sincere', and 'good' and rigidly hold to alien edicts. Something is wrong with this picture. Can the channel be changed? (no pun intended)

If it is NOT correct because these folks are full of bull or are sincere but just mistaken or are deceivers then spiritually developed people should not necessarily get too worked up or believe all the information and predictions coming forth from this Dharma person's writings!

However, it is possible that BOTH are true, at least to some degree, by virtue of the fact that for some, they will become true, and for others who will be in a more positive global earth reality dimensional 'split-off' (no scientific basis here, only acknowledgement of possible hypotheses based in macroscopically applied quantum physics principles scientifically repeatedly verified over the last 50 years), these things will NOT come to pass.

In YOUR Reality the 'Predictions' May be Minimized
or found UNTRUE and there will be NO need for rapture, NO nuclear holocaust, NO massive wipeout of mankind from AIDS type diseases, NO comet turning our skies red, NO second star coming into or appearing in our solar system, etc. In fact we could move into a 'new age' that is beautiful, loving and productive by the actions of those whose intelligence, compassion, and consciousness is determining that it BE that way. The entire fear inciting predictions may be part of a covert alien indoctrination operation designed to get people to BELIEVE and therefore CREATE them happening for unknown alien control purposes.

HOW Will the Dire Predictions NOT Occur?

First of all, don't hold as oracle or absolute truth anything any alien says. Just because they have advanced technology does NOT mean they are spiritually developed any more than you, nor that they can know all possibilities of the future. They may have an agenda that fits their spiritual limitations.

Even if they were indeed slated to occur for masses of those adhering to the collective or consensus consciousness blueprint for the future, it could only be through personal productive and objective conscious choice and personal conscious spiritual dominion that they would NOT occur. We are talking about the power in each individual to decide for themselves, consciously, spiritually, and honestly.

What IS clear is that if both can become true in at least two diverging global realities, is that RIGHT NOW (November 1989), and through to the end of the next decade, we are in a nexus of reality where they have NOT wholly split off yet and of course there is a CHOICE in the matter (yes this stretches the limits of believability and even credibility of this report).

Those of us who would create a world where the biblical end-times 'horrors' will NOT happen are just getting heavy exposure to the collective or consensus consciousness blueprint adherents who are in compliance that the horrors WILL ALL HAPPEN, exactly according to the biblical schedule, aided by aliens who are in that same reality set.

Things are not destined to go the way of Hatonn's 1989 predictions for everyone, but may indeed come to pass for many, if Hatonn and his aliens are real, and are accurate.

If that is so, then it is important that the existence of REAL CHOICE in the matter be totally clarified, rather than once again like in 1981 be laid forth as absolute, inflexible, and foregone conclusion. There are lots of

'if's' here, and it is expected that there is a high probability that this entire discourse is a flimsy house of cards. Regardless, quantum physics holds that human conscious expectation and choice and imagination can immensely impact what happens, and that there are options being broadcast and attempts to narrow the field of possibilities to singularities for humanity, based on the biased preferences of the alien broadcasters.

However, we ARE attempting to sort out and follow the house of cards map as it is being built, thanks to all the 'alien' sourced fear inciting data that is becoming more and more popularized.

It is also important to therefore become conscious and determined about developing the requisite degree of personal spirituality such that you can be in the reality 'set' where these horrible worst case predictions become failed and forgotten predictions. It could be up to you, individually, to choose what 'reality' you want to believe, adhere to, and thus experience.

The issue is one of choosing a nightmare, choosing mediocrity, or choosing a positive dream. The nightmare holds a fast or more likely a slow agonizing death of the world. The dream holds a world that will survive, then thrive, and maybe live on ad-infinitum. The choice is most probably a personal spiritual one, not a collective "momentum" one.

If We 'Buy' the Malevolent Alien's Manipulations

we could be in for plenty of difficulties. These malevolent aliens have allied themselves with the secret world government whose thirst for power and power system survival is probably only unrequited by the malevolent aliens themselves. That is still probably the case, regardless of the previous prediction and metaphysical non-scientific discussion.

The malevolent aliens have given advanced technology to the government, manipulated, lied to, deceived, and generally used our secret government for their selfish and inhumane alien ends.

The malevolent aliens succeeded, at least initially, in the implementing of a grand deception for the purpose of taking root on the planet by receiving assistance from the secret government in building bases in the U.S., obtaining biological supplies for their genetic experiments (maybe to eventually produce a more human looking alien that will more easily 'fit in' on earth) by abducting humans and animals to help effect their genetic transformations.

The malevolent aliens may have set a monstrous strategy in motion, which originally began thousands of years ago, when all alien colonists mutually agreed to leave earth and its peoples to their own evolutionary development, but the malevolent aliens did in fact subvert that plan and established a number of very secret covert operations bases underground on earth, which exist and are operating to this present day.

The alien strategy's primary fulcrum rests on the malevolent aliens ability to gain psychological control and allegiance of the majority of humanity as a populace before any benevolent or competing malevolent aliens have an opportunity to develop similar allegiances.

On this basis these evil aliens can effect 1) a covert subjugation of earth secret government, and 2) a mass overt colonization of earth with earth people's consent before thinking humanity actually recognizes their fundamentally evil intentions and goals. These are unpleasant prospects.

Then it would be too late, especially if the malevolent alien's were so successful that humanity at large became so loyalized to the malevolents that the benevolent aliens would have difficulty making mass contact on any permissible by galactic law basis.

All This Malevolent Alien Crap May be Koot However

Even the existence of these aliens, if recognized, provides fuel for their game of seducing people into believing they are real, and therefore entirely helpless in the face of them. A face of god in a high-tech mask made for a high-tech society.

People can decide they exist, but those who DO make pro-active personal choices can mitigate or obviate the potential alien problem in the first place. There are spiritual dynamics at work here that indicate that we don't have to put our heads in the sand, but we also don't need to buy the 'line' either. We can create and choose and generate a 'line' of reality and future that eliminates their influence as a concern.

But before we get to that, let's continue the scenario regarding the malevolent aliens and the secret government and all that fear inducing reality just to be clear about it. DO NOT GET lost in it however; there is an alternative reality.

The MJ-12 Controlled Information Release Pradigmatic

MJ-12 realized almost two decades ago that the aliens they were involved with, and with whom they had a formal written 'agreement', were the malevolent ones and were very likely implementing a monstrous covert invasion strategy.

However the release of this information is still considered far too explosive and would cause a widespread catastrophe governmentally, economically, religiously, and militarily - world wide. As a result, MJ-12 is caught between being in bed with the wrong alien partners with no means to just get up and walk out of the bedroom.

The counter-strategies that MJ-12 has developed in hopes of reversing the current debacle include military, economic, religious, media, and other methods:

Military - Develop Anti-Alien Weapons

that can destroy their spacecraft, and as importantly, destroy their underground bases which the secret U.S. government originally helped the aliens to build.

The positive benevolent aliens are not permitted by their own laws to help us by giving us defensive weapons against the malevolents.

The SDI cover program and other programs are in progress and it is believed that some weapons have been developed, but not the critical weapon that can destroy the underground alien bases.

Also develop escape alternatives for a select group of humanity in case the malevolent aliens are successful in their strategy.

Also develop contingency plans for implementing martial law as a means to effect damage control BEFORE the aliens actually make mass colonization efforts obvious. That way, the media can be completely controlled and free speech can be stopped from making the whole truth available to most people.

Economic - Develop a Centralization of World Economy

so that in the event of full exposure, their at least is existing coordinated control of the markets and production capabilities worldwide.

Enjoin other earth governments to ally themselves with the U.S. to have a unified response to the alien threat.

Religious - MJ-12 Does Not Know Yet. But

the so called "anti-christ" may in fact turn out to be an individual who will attempt to save earth humanity from coming ultimate religious and physical subjugation by the malevolent aliens by this individual revealing the malevolent alien's intent and will attempt to reveal to humanity the historical depth of the malevolent alien's manipulation of earth humanity.

This 'anti-christ', if ever to physically exist and be 'a human person', could be Billy Meier or someone who clearly gets the message from him or the Pleiadians themselves in this scenario. In this scenario, the individual is called the 'anti-christ', since the malevolent aliens are responsible for the new testament 'christ' and wish to have the world be wrathful towards anyone who might attempt to subvert their religious deception or global manipulation plans.

This individual could have major planetary religious, political and economic impact as someone who has humanity's best interests in mind, which is TOTALLY contrary to the accepted religious belief that this individual is penultimate evil and must be destroyed.

Unfortunately again, in this scenario the individual who would, by the revelations predictions, be the one who is the 'real Christ' returning to save the 'faithful' and 'rule' on earth, will actually be a 'highly trained for the part' humanoid created or at least controlled by the malevolent aliens. However this may NOT occur: if the so called anti-christ is successful in disseminating the real truth, including the original unaltered scripture of Jmanuel and the whole, unsanitized, Meier contact notes in a manner that lifts at least some of the near 2000 year old veils of deception.

If this person is not successful, then the Biblical revelations predictions may occur for some, with the malevolent aliens able to come out smelling like roses, playing a 'good' god and 'christ' figure, but in actual fact are the true 'devils' in disguise ('devils' from the view point of human spiritual free will in a non-deceptive growth environment having any value).

On the OTHER HAND, in an alternate scenario, regardless that it is indicated in the Meier transcripts that an individual and organization who is associated with the number '666' is NOT Meier or other 'benevolent' persons and IS in league with the negative aliens and their global covert subjugation of humanity through religion and that the individual associated

'anti-christ' IS NOT '666' and IS benevolent), the 'anti-christ' then is indeed the 'bad guy', and later, after this genesis of humanity has gotten his 'airtime', that the fellow identified as Sananda will be the true and good 'Christ' returning to "make things right".

Overcoming the Malevolent Alien Strategy

Given its 2000 year preparation and their resultant excellent conditioning and programming of humanity through delusion of religion will be very difficult at best. The possible mistaken identity problems could make for a planetary wide debacle. And when confused, most adhere to their longest stable self references in life.

If the first scenario is true, the real depth of the long historical programming and conditioning of earth humanity may be playing right into the malevolent alien's scaly grey claws.

MJ-12 may not have a contingency plan for religious countermeasures since they may remain in confusion as to who is who, and just don't know what to do. Given they are in league with malevolents, they know that for certain. But more is not necessarily better. If MJ-12 did one thing right it would be to do everything possible to support Billy Meier getting his message out, which appears to already be in progress in a metered fashion (AMEX card holder 1989 Christmas catalog contains Meier Videotapes for sale - a start at least).

Media - News in a Metered Fashion

have the news and entertainment media provide conditioning and cushioning of the coming frightening truth disclosures.

In the news media, start with the fringe element publishers in the UFOlogy community and maybe 'new age' community to begin slow release of more and more credible information as to the existence of the aliens and the government's Faustian relationship to them.

Eventually a credible enough mass or nexus of information will exist that can serve to begin to educate and prepare earth humanity for the

alien presence and understanding their intentions, and discerning who is benevolent and who is malevolent.

Eventually when it threatens to become a watergate scandal of national proportions, to have the U.S. president make a statement acknowledging the situation and in the same instant maybe declare martial law to control the panic response from middle america that is fully expected.

In the entertainment media, covertly support those productions that indicate the malevolence of the short big headed grey aliens ('grays') and their cohorts that actually are malevolent, in hopes of counteracting and reversing the previous deep conditioning job that was done to have earth people favorably receive the malevolent aliens as the Christian 'god's messengers and angels' disguise. The aliens probably have similar plans for other major religions and their adherents, including Islam and Hinduism.

Other Methods

include:

- i) the continued tacit cooperative relationship with the malevolent aliens in hope of buying time to complete effective weaponry against the malevolent aliens,
- ii) identifying and training credible nationally known individuals to act as sources of perspective for the nation and the world in the event of mass contact or mass exposure of the truth,
- iii) development of biological warfare effective against the aliens but harmless (sic) to humans and animals and plant life,
- iv) infiltration and interception of other malevolent alien information contactees, and infiltration and interception of any benevolent alien information contactees in an effort to control the rate of release of any hard truth to the public or credible influential individuals or organizations.

This includes the standard practices of ridicule and debunking to continue to promulgate the atmosphere of "unbelievability" and "fantasy" relating to the alien question.

v) expansion of 'glasnost' in the Soviet Union to soften the blow to the world that the two superpowers are by necessity complete allies with respect to being in agreement to combat the malevolent aliens.

This may be mitigated if the malevolent aliens are able to deceive the Russians into thinking they are better off with these aliens as their allies than enemies, regardless of what the U.S. does or believes.

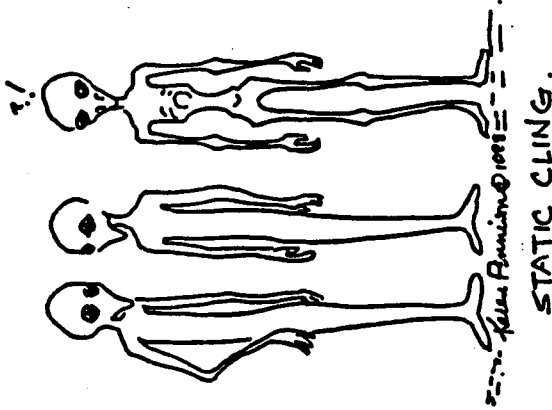

Disinformation Objectives and Strategies

Disinformation is used to accomplish several objectives:

1. Put people off the scent of the trail to information that somebody wants kept unknown or unpopularized.
2. Develop reactions and dispositions in a populace or group that can be later used to the disinformers advantage.
3. Cause or trigger actions and activity that can delay discovery of the true information for purposes of gaining a time advantage.

Disinformation Strategies:

1. Contrary and opposing false story explanation
2. Parallel and similar false story explanation
3. True story in different or similar domain which diverts attention from a story targeted to be suppressed

Offensive Reasons:

1. 'Head them off at the pass' - Exposure or disclosure prevention
2. Effect belief indoctrination for some later advantage or current purpose.

Defensive Reasons:

1. Exposure or disclosure containment

Conspiracies-Subjective Gestalt or Objective Reality

Conspiracy theories and stories provide an all encompassing explanation for a collection of facts and suppositions that without which would remain just that - a collection of facts and conjecture.

People who are 'pro' conspiracy have different kinds of motivations:

1. Have some need to make 'sense' of a collection of malevolent events. They want to feel there is one thing to point at as the cause of it all. They wish for simplicity, usually out of not wanting to see things as complex and unexplainable. They would rather not really think things through only to discover its a very complicated world, but would rather like to be able to easily dispose of the scatter of information in an one fell swoop manner. In essence, it is a motivation of laziness and desire for simplicity in life.
2. Actually have clearly been exposed to real conspiracy and have been exposed to a sufficient fact or conjecture base that even if they are initially non-conspiracy oriented, try as they might, they find that attempts at disproving a conspiracy theory only reinforces the conclusion that a conspiracy exists. These people are motivated out of a desire to understand the nature of things, and could care less if it life is complicated. They are motivated out of true curiosity and desire for knowledge.

People who are 'con' conspiracy have different kinds of motivations as well:

1. They tend to not believe that most things in life have any meaningful connections, that life is relatively stochastic and random.
2. They are usually scientific and conservative in orientation, and automatically view with cynicism or strong skepticism any statements that even smell of a conspiratorial nature.

3. They believe that people, groups, and organizations are basically good and wouldn't do these things, or alternatively
4. They believe that such people or organizations are not capable of actually implementing a so-called conspiracy.
5. They were led down the primrose path of a conspiratorial explanation of something in the past, were later proven wrong, felt embarrassed, foolish, 'conned' and or humiliated, and out of relative reaction to that previous episode will not be caught dead 'buying' such an explanation of things again.
6. Apathy, pure and simple. Couldn't care less about conspiracies and all that crazy 'stuff'.

Organizational Security--Need to Know'

- 'Need to know' is a method that effects compartmentalization of information, meaning, and purpose.
- It insures that if a leak occurs, it is manageable and limited.
- It keeps global strategy secret and unknown.
- It provides secrecy as to the intent and value of information.
- It allows the fast tracking down of the sources of leaks.
- It allows for camouflaging if necessary of the purpose of a compartmentalized activity so that those in their respective 'need to know' compartment will know even less, by virtue of what they know being essentially encrypted.
- It prevents unauthorized and unwanted opinionation from developing which can result in possible dissension and conflict between the compartmentalized subjects and their immediate need to know superiors.
- It allows for alternate 'cover' need to know compartments to exist to provide diversionary information or sleeping disinformation in case of compartment penetration.

It allows the entire vertical (as well as horizontal) hierarchy of information and intelligence gathering to not know the scope or purpose at any point in the hierarchy, except of course at the top where the compartmentalized 'need to know' information pathways all converge.

Terms:

- Resource - ultimate information leak point, or direct witness
- Source - intermediate information leak point, witness contact
- Destination - mass or fringe media, association, organization dissemination point
- Populace - influential public or private - ultimate information destination targets

- The domain of discourse and belief and the effective participants within those domains defines the nature of the control and containment problem.
- If the domain is a 'Resource' witness or alien contactee, then it is often readily contained.
- If the domain is a 'Source' information transfer agent it can also be often readily contained.
- If the domain is a 'Destination' media or organization is also most often readily contained given objective verifiable data has not reached that point, or if it has reached that point and the media in question is mainstream in nature, then it is still readily discredited by respected experts, or if necessary contained via invoking national security laws and procedures.

However once the information has reached the 'Populace' ultimate destination points such information can often become uncontrollable, producing reaction from hysteria to acceptance.

It can be critical to keep in mind the variations and nuances of belief, argument, and evidence that can be utilized or manipulated to effect suppression or emphasis of information or disinformation as required to implement the tactical objectives.

Information Source/Resource Control and Containment

Source/resource invisible surveillance and monitoring

Communications monitoring

Mail - recording
Phone - recording
Finances - recording
Lateral related parties monitoring and recording

Activities monitoring

General physical activities - recording
Sensitive activities - multiple point recording

Covert penetration and alliance

Via 'as-if' alternate 'resource'
Via individual friendly sympathizer
Via 'as-if' 'destination representative'
Via associations, organizations, groups

Source/resource cease and desist tactics

Overt control and fear tactics

Via black tactical overt emotive controls
Via alien impersonation
Via electronic emotive or thought implantation
Via anonymous warnings and related statements

Mental illness induction - paranoia, psychosis, schizophrenia

Via covert electronic techniques
Via overt belief baiting

Life disruption and distraction

Via legal problem set-ups

Illegal activity set ups - e.g. drugs, rape, white collar
crime set ups and entrapments

Via financial problem set-ups

Internal Revenue Service audits
Credit history problems

Via physical health problem set-ups

Covert electronic techniques - microwave, ELF, subsonic
Covert material techniques - poison, infection, etc

Disinformation baiting

Overt 'as-if' collateral 'enlistment' and alliance

Fantasy organization enlistment

Via alternate collateral resources

Exaggeration to make unbelievable or disprovable
Doubting data to disconcert or discredit resource
Distract-lead them down a irresistible but dead-end road

Source-to-resource access disruption and sabotage

Resource information transfer interception

Resource cease and desist tactics

Source-to-destination information transfer interception

Mail interception

Phone and electronic media interception

Physical transport interception

Information Destination Control and Containment

Source discrediting and effective malignment:

Direct interference tactics

Agency or organization story plant

e.g. "it was a weather balloon, swamp gas, or delusion"

Scientific expert debunking and discrediting

e.g. "this has no basis in fact, evidence or reason"

Source ranks expert debunking and discrediting

e.g. "this is giving the field a bad name"

Source credibility damage

e.g. "this person cannot be believed because they..."

Disinformation baiting

Nonsense exaggeration and fantasy scheme
Sense exaggeration as wild or scary or hysterical
Associating with known unreliable people
Associating with discredited known fringe 'cults'

Source domain topic discrediting and subterfuge

Indirect interference tactics

Parallel false story dilution effect (thunder stealing)

Via disinformation 'leak' near same time

Opposite false story dilution effect (impact dulling)

Via disinformation 'leak' near same time

General societal public opinion baiting

Via alien 'contact' set-ups

Via fringe organizations and related publication media

Via covert support of mass media projects that will exaggerate, discredit, make it into science fiction

Via official sanctioned space related activities which provide a consensus objectivity security 'belt' for public opinion

Via official sanctioned extraterrestrial intelligence activity which also provides an effective consensus objectivity security 'belt' for public opinion

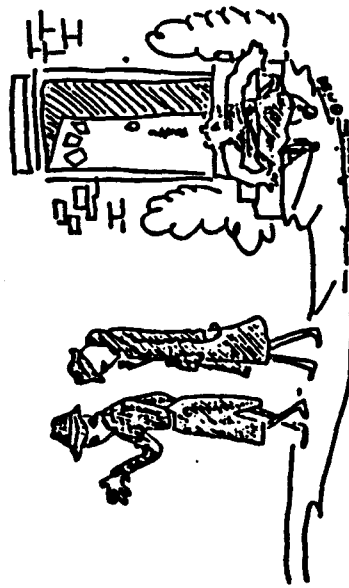

**NEXT TIME WE PRETEND WE'RE FBI...
JUST SHOW YOUR BADGE AND KEEP
YOUR RAINCOAT CLOSED!**

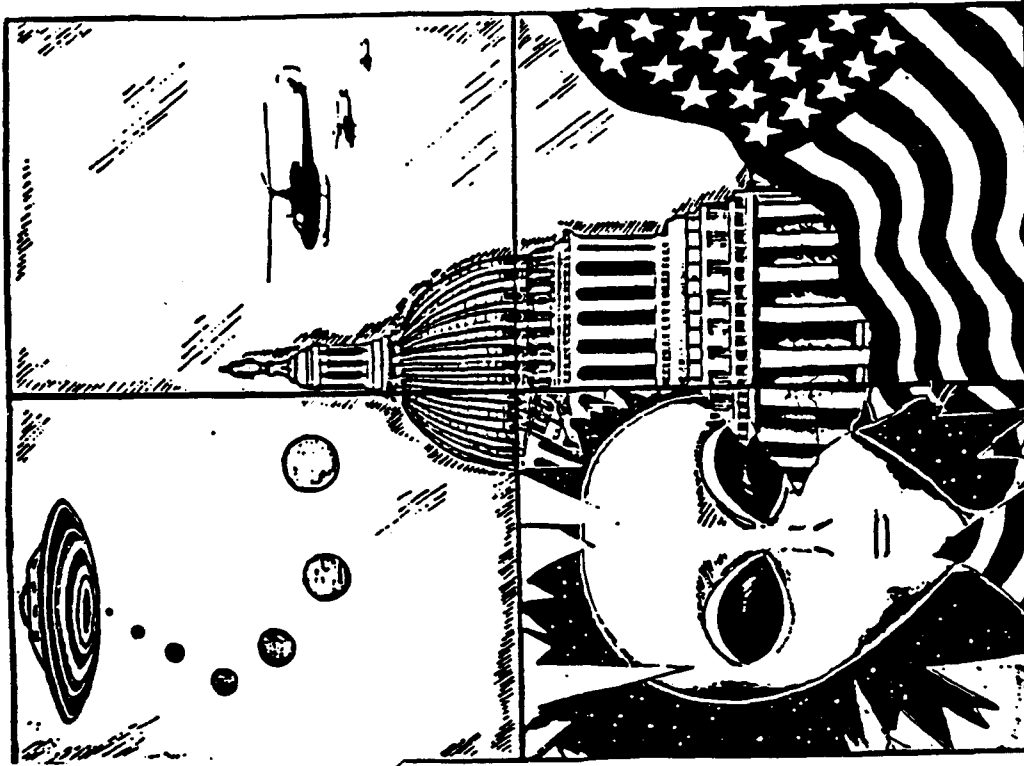

(From Top Secret/ Apotheosis (c) 1969 Nexus Seven)

Brainwashing Techniques and Psychological Control Strategies

There are a multitude of so-called brainwashing techniques. They can be effected consciously or subconsciously. The basic common denominator in all brainwashing is some type or level of 'story immersion'. This immersion can require that several conditions be met to achieve the desired result.

Let us assume that we want to make someone believe something that is quite contrary to what they may have believed before, which is a little bit harder than making someone believe something in the face of no prior or counterbeliefs.

The process of immersion of a human subject into a target belief we shall call 'BI' proceeds as follows:

1. Do not immerse the subject into the target belief too quickly, for that may arouse negative reaction based on their existing counter-belief. Instead, effect immersion slowly so as to ally the subject to the notion that the brainwashers (the subject does not know they are brainwashers but we shall refer to them as such) have beliefs in common with his already accepted beliefs, but not the subject's already existing counter-belief. This produces an atmosphere of companionship, trust, and common belief - i.e. belonging.

2. Once common ground has been established between the subject and the brainwashers, the actual 'washing' process begins.

a. First, the subject must be relatively isolated from those environmental influences which tend to continue reinforcement of their counter-belief. Often a subject may only persist a given belief by virtue of its continued reinforcement and usefulness as an explanatory notion. Complement this with full immersion into the isolated environment, i.e. do not let the subject have any opportunity to even reflect with regards to any other environment. This can be accomplished by having constant, unbroken companionship between the subject and the brainwasher operative.

b. Second, begin to generate a deeper emotional and subjective alliance and allegiance and trust in the subject towards the brainwashers. Deepen the common ground and sense of belonging and companionship.

c. Third, slowly begin to commence the immersion into the target belief. This is not immersion into the target belief directly and explicitly, but immersion into camouflaged forms of the belief, forms which are palatable, and still do not trigger counter-belief argument or positioning. Complement this process with increasing emotional allegiance (friendship or lover or other) activity. Alternate activities which focus on the camouflaged target belief indoctrination and activities which deepen the emotional allegiance of the subject.

d. Fourth, as it is assessed that the subject has substantially begun acceptance of the camouflaged version of the target belief, begin to slowly dismantle the subject previous counter-belief. This is accomplished by 'baiting' camouflaged versions of the subject's counter-belief in a playful manner while in emotional immersion of belonging and companionship with the brainwasher operative(s).

e. Engage framing the sensibility of the counter-belief in terms that will later be found to be subservient to terms found in the target belief. Establish that the counter-belief is not effective nor useful any longer now that a more 'useful' (in the isolated setting however) way of seeing things exist. All the while, reinforce emotional allegiance intermittently. Immerse the individual into a sense of peacefulness or 'just cause' and adequacy regarding the camouflaged target belief.

f. Remove the individual's last connections and familiar habits relating to his originating environment. This is accomplished by operating according to a schedule which is relatively unpredictable in contrast to their originating life habits. If necessary, slowly effect, with explanatory justification and positive reinforcement, a reduction of sleep time. If necessary, reduce protein intake and effect dietary changes. In essence, implement a new life patterning such that all relevant previous life patterning habits that would tend in any manner to reinforce the subject's counter-belief are eliminated.

9. Now for the first time, when the subject has repeatedly, under a variety of mental, physical, and emotional conditions, indicated allegiance to the target belief and appears to not reference the counter-belief any longer, begin direct target belief indoctrination. At this point it is important to not even acknowledge the existence of the subjects non-camouflaged counter-belief, but to only focus all energy onto the target belief structure and nuances. h. As the subject indicates their understanding and emotional and intellectual acceptance of the target belief in its naked, uncamouflaged form, now begin to more directly address all the subject's relevant originating environmental references in a manner that allows the target belief to provide acceptable explanation and re-contextualization into the target belief.

This process makes certain that once the individual returns to their originating environment and influences that the target belief has adequately provided a means to see such environment and influences totally and only in the 'light' of the newly accepted target belief or belief system. The subject's filter of experience, interpretation, and assignment of meaning and reference now is functionally the target belief itself.

The 'brainwashing' process is now 'complete'.

It is often found that this entire above procedure and process may occur in a number of cycles from beginning to end, with each cycle achieving a deeper layer of belief indoctrination.

If the target belief is not too far from the subject's original counter-belief then repetitive cycling at deeper and deeper layers is effective.

If the target belief is quite distant and deeply contradictory to the subject's original counter-belief, then either the brainwashing process must be contained in one singular deep cycle, or the multiple cycles must exclude in g. and h. the full non-camouflaged exposure to the target belief. This essentially is never telling the subject what it is they are really being led to believe in explicit terms or for what purpose, but rather maintaining deep camouflage and 'cover' until after many increasingly deepening cycles are effected and accomplished.

Brainwashing can occur on an individual basis or on mass basis. It can occur subliminally, covertly, subconsciously, and slowly. It can be only slightly influential in the beginning but later controlling without conscious recognition by the subject or group.

Once accomplished to any effective degree, the installed target belief or beliefs will begin to color or filter experience in a manner that provides consistency and reinforcement to the target belief. In that respect, once begun, without counter-programming, the target belief and brainwashing can become self perpetuating, and in fact even get out of control to the point the subject expands beyond the confines of the target belief and develops a whole set of supporting and expanding beliefs, as is necessary to provide explanatory peace within the developing belief system.

Deception Strategies of Alien Races

Given the assumption there are technologically advanced extraterrestrial alien races visiting and potentially attempting to covertly subjugate humanity on Earth for certain 'nefarious' purposes;

and given the indications to this effect detailed in the Meier related Pleiadean alien contacts, and the plausible examples of these nefarious activities operating under an easily perceived 'positive and benevolent' cover;

which include such as those aliens referred to in the Meier notes as Kamagol-led Bafath creatures, Orion Betelguese creatures in the M.W. Cooper notes, and the Ashtar Sheran/Sananda/Hatonn types who have transmitted information through Solar Cross, Mark-Age, Guardian Action International, A.S.S.K., Tuella, Sister Thedra, and recently Dharma (to name a few),

we can begin to construct a detailing of the actual deception strategies under engagement:

If we follow the hypothesis that the Meier contact notes are essentially correct with regards to alien deception strategy, and the Orion Betelgeuse malevolents are effectively at odds with or competitive to the Ashtar group of aliens, and the Ashtar group is also malevolent and parading under the banner of Christian savior Jesus 'second coming' activities, a very complex, multi-level, well crafted deception strategy and tactics starts to come into view.

Elements of the Deception Strategy

1. 2000 year (or more) set-up context
2. Develop covert alliances via 'positive' appearing cover
3. Factionalize malevolents into apparently opposing groups
4. Develop and use religion as a set-up

(From Top Secret/ Apotheosis (c) 1989 Nexus Seven)

5. Influence religious history through miracles, etc.
6. Present themselves as divine, godly, angelic
7. Tailor contact tactics to multiple group receptivity factors
8. Use apparent opposition between alien groups to incite fear of 'negatives' and loyalty to 'positives' - a dualistic dynamic
9. Effect more than one religion, thus having relatively opposing religious groups
10. Structure and influence specific non-religious political and economic groups also into multiple, incompatible factions
11. Opportunistically influence human groups and individuals as their popularity proves to be of value
12. Gradually transition from entirely covert to partially covert activities - i.e. select certain influential economic and or political governmental groups for overt contact
13. Match contact tactics to fit expectations of contactees - gods and angels for the religious, technology for the military, control for the government and economic powers, 'outsider' conspiracy information for the gullible and wanting conspiracists, etc.
14. Keep believers fanatical
15. Keep disbelievers polarized
16. Corrupt societal archetypes about who is who amongst the aliens
17. Incite covert and overt preparations for eventual full overt contact worldwide
18. Influence governments and mythology and religion and media, subliminally and subconsciously to accept aliens, and then openly prepare and condition the mass populace towards acceptance of the idea, then reality of alien races

(From Top Secret/ Apotheosis (c) 1989 Nexus Seven)

19. Prepare alien contact scenarios for inducing fear into the populace, and thereby allegiance to the only protection from the negative aliens - that is - ally to the 'positive' aliens (which are negatives in deep cover)

20. Gain allegiance of the populace via these above deception tactics, prior to the truly benevolent aliens having 'legal' opportunity to make mass contact

21. Make the truly benevolent aliens appear as being the ones only parading to be negative - decoy people fears towards the truly positive benevolent aliens so when they do make large scale or influential private scale contact, that the populace or influentials will react negatively towards them and reject any overtures

22. Reduce the apparency in human minds that there exist options beyond what the aliens can present

23. By use of technology that in greatly in advance of human earth technology, induce the belief in humanity that aliens know better for humanity than humanity

24. Deny there exists choice that can be spiritually exercised by humanity that can obviate the entire alien games and reality 'set'.

The Malevolent 'Soul Processing' Hypotheses

1. A BEST CASE hypothesis regarding the true intent of the most malevolent alien races interacting with Earth humanity and their intentions and goals

Components of the Hypothesis:

1. Inculcation of human populace towards acceptability of aliens - a co-existence preparative activity
2. Identification and conditioning of selected target subjects to be used as disseminators into Earth fringe and mass media

(From Top Secret/ Apotheosis (c) 1989 Nexus Seven.

3. 'Upper hand' programming and conditioning of selected humans to 'revere' aliens in a semi- or direct religious manner
4. Aliens using human religions and psychic phenomena and dimensional ET interaction
5. Use of human vulnerability to spiritual domains and corruption of religious traditions, and metaphysical traditions, as those traditions provide humanity's greatest nexus of personal influence and power over the long term, greater than political, social, and other cultural endeavor and domains of power
6. Inculcation techniques encompassing the following:
 - a. subconscious conditioning, subliminal to conscious awareness
 - b. use of archetypal images of Earth traditions, ritualistic activity
 - c. now contemporary ritualistic domains, such as high technology 'god' for a high technology society
 - d. emotional conditioning at a feeling, intuitive, spiritual, and 'soul' level
 - e. mental intellectual conditioning, towards intelligence and technology and advanced sciences beyond the scope of current Earthly technology
 - f. metaphysical, 'spiritual', new mythic religion making - a modern day religious cult creation
 - g. use of standard and advanced behavioral conditioning and 'brainwashing' techniques, including use of fear, depression, anger, hurt, loss, love, mercy, ruthlessness, dispassion, passion, sexuality, etc, as subjective motivator media to inculcate certain conditionings and programmings
7. Alien plan to establish inherent human social controls so that eventual overt contact activity on a mass or partial mass scale will bear fruit of acceptance and tacit allegiance

(From Top Secret/ Apotheosis (c) 1989 Nexus Seven)

- a higher certainty of social integration between humans and aliens with aliens holding a governmental and spiritual senior position to human developed governments and religions, by virtue of using the ready made governmental and religious concerns and archetypal images to the aliens own advantage

8. Human religion is critical to acceptability factors of alien contact on any major scale. Therefore, in this context, 'soul processing' is a complex set of alien techniques in use to bring humans into alien allegiance at a deep, spiritualistic, 'soul' level, thereby assuring no effective counter-tactic (mental, emotional, or physical) will hold senior power over the alien conditioning of humans, precisely because the level of allegiance has been formed and programmed at the deepest conscious, subconscious, and archetypal levels of awareness in humans - that is - at the core of spiritual needs and perception of the targeted human subjects

9. The 'soul level processing' therefore is a method of conditioning humanity for any or some or all of the following possible purposes:

a. human 'harvesting' for seeding other civilizations or for use as labor

b. creating allegiance or acceptance factor that effectively permits greater and greater contact activity to occur, eventually at a mass contact level

c. conditioning for eventual overt co-existence of humanity with aliens on earth, influencing government, economics, education, religion, culture etc.

d. conditioning for development of newly embodied religions that work from existing religions forward to now have aliens be the 'heavenly sons', 'gods messengers', 'angels', 'saviours', 'brethren', 'ancestors', 'evolutionary futures', 'second coming', 'spiritual confederation representatives', etc.

(From Top Secret/ Apotheosis (c) 1989 Nexus Seven)

II. A WORST CASE hypothesis regarding the true intent of the most malevolent alien races interacting with Earth humanity and their evil intentions and goals

Components of the Hypothesis:

1. 'Compliant' humans can be 'legally' 'harvested' for various 'slavery' purposes
2. Humans are effectively considered raw materials
3. 'Raw materials' can include humans used as:
 - a. physical services for aliens performed - direct labor
 - as slave labor, menial chores from alien point of view
 - as slave labor, dangerous work, expendable
 - for pseudo-voluntary labor for various purposes on earth bases, an effective agent for aliens
 - for sexual purposes, alien pleasures
 - for teaching aliens how humans are and what makes them tick
 - b. recruiters of other humans - indirect/remote labor
 - for bringing more humans into allegiance to aliens
 - for bringing more humans into understanding alien presence
 - for bringing more humans into awareness of alien presence
 - for training human to become good emissaries for aliens for later activities
 - for acting as communication go-between for aliens with humans by virtue of bi-lateral capacity to communicate with both

(From Top Secret/ Apotheosis (c) 1989 Nexus Seven)

c. source of biological materials, living:
(blood, sperm, ovums)

- for alien human hybridization experiments, strategies
- for nutrition
- for discovering means to influence, damage, control, modify human genetics
- for genetic materials as stock for experiments of various kinds

d. source of biological materials, 'dead' (c. + live body parts)

- for genetic and alien/human hybridization experiments
- for alien biological cloning activities, i.e. stock support biology or for other biological growth environment purposes
- for alien bio-protheses
- for producing 'in vivo' human organ experimentation

e. source of emotional energy, living

- for technical learning purposes, study and experimentation
- for osmotic or resonant learning, evolutionary or spiritual development purposes
- for parasitic energy usage by aliens
- for degenerate pleasure purposes, torture, causing pain as 'fun'

f. source of mental energy, living

- for technical learning purposes, study and experimentation
- for 'osmotic' or resonant learning, evolutionary or mental adaptation or discovery purposes to be able to tolerate humans
- for parasitic energy usage by aliens

(From Top Secret/ Apotheosis (c) 1989 Nexus Seven)

g. source of life force consciousness, souls

4. Treating only 3.g. above, the process whereby the literal soul 'I' of a human being is subjugated for some purpose, would include the following steps with the assumption of using human bodies and souls for hosting alien souls and 'subtle' bodies:

a. a means to condition the human host body and soul to accept or tolerate alien soul and subtle body presence/occupation/habitation

b. a means to condition the alien soul and subtle body for tolerating human host body and soul

c. means to enter, implant, or assume residence into the human body and soul in a controlled and contained manner

d. means to functionally interface or integrate with human soul and mind and emotional characteristics for learning and acclimation purposes, and exploration and evolutionary purposes for the alien's benefit, or for the benefit of something beyond the alien itself (e.g. functional communication interface between alien and human systems).

This process could be for purposes of providing a means for allowing an alien soul form to migrate from its source dimensional residence and use human bodies and souls to anchor their presence and eventual full migration to this time-space dimensionality. This process of migration may take a substantial time period of setting up linkage, anchoring, partial migration, and eventually total migration (the alien now has a body in this dimension, albeit a human body) at which time of completion the alien may:

a. effect complete fusion with human soul, at least for the effective body life

b. effect fusion with the human soul for longer than the life of the body

(From Top Secret/ Apotheosis (c) 1989 Nexus Seven)

c. co-exist with the human soul and thereby produce some evolutionary effect for alien soul form

d. depose the human soul from the human body, the human soul having effected it usefulness in the anchoring and migration process at which point the alien can now fully take over the human body control functions without risk of body death or disease.

e. effect subjugation of human soul form into autonomic only function (from the alien point of view), thus now the alien soul form has full control whereas prior to that would have attempted to remain covertly present

5. With the assumption of using human souls in alien bodies (once again treating only 3.g. above):

a. a means to separate the human soul from the physical body

b. a means to blind it from previous memory patternings

c. a means to captively contain the soul or 'I' of the subject

d. a means to recondition the soul for new particular life function

e. a means to captively implant the soul into a target body

f. a means to condition the soul with a new life purpose

g. a means to maintain control over the entire life function period

These malevolent aliens are intent on using human souls, in part or whole, to implant them into new bodies under direct alien control, thus increasing the ranks of their minions for advanced labor purposes.

6. The critical issue of conscious compliance is required for a human to be used as such as indicate in 4. and 5. above.

(From Top Secret/ Apotheosis (c) 1989 Nexus Seven)

a. Such compliance only need occur at a conscious level at least at one significant point in the process, and all subsequent compliance may be unconscious or subconscious, and therefore resisted, or involuntary, at other points in the subjugation process.

b. This compliance can occur as a result of deceptive practices so as to mislead the subject, getting them to believe the process they are engaging in is for their 'good', for their 'evolution', and is desirable.

c. Violation of the law of conscious compliance could possibly have severe consequences for the violator, and thus even the most malevolent aliens would take this into consideration.

d. Of course the aliens would try to find any loopholes in the application of this law that would not bring down some 'karmic' or 'police' action, such as controlling the milieu of the conscious choice making so that the chooser would have restricted information or even false information or unfathomable information.

e. This information or 'truth' which would form the basis from which a conscious compliant choice would have to be made could be itself 'truth' that is framed or manipulated to the alien advantage.

7. The purpose and goals of subjugating human souls into service in new bodies for the malevolent aliens include as follows:

a. using human souls as a preemptive means to populate the planet with aliens (with human souls, reconditioned), since humans have first right of refusal in planetary ownership - the 'invasion' theory, i.e., an effective covert gradient for alien occupation of earth before other permitted occupation opportunities could legitimately occur

b. using human souls in alien bodies to build ranks of servants to control other human in human bodies - the resonant control theory, i.e. humans in alien bodies can interact/control humans in human bodies more effectively or efficiently than alien souls in

(From Top Secret/ Apotheosis (c) 1989 Nexus Seven)

alien bodies can control humans, due to differences in fundamental telepathic and other resonant synchronization and linkage characteristics

c. using human souls in alien bodies, under malevolent alien control, to claim the planet after humanity 'dies out' - the reclamation and evolutionary adaptation theory - whereby the new bodies can both physically survive in a greenhouse hothouse environment that humans cannot, and can resist diseases (AIDS) that humans cannot

d. using human souls in alien bodies to build ranks of ambulatory hosts for malevolent spirits to inhabit (subsoul slavery to another alien soul, i.e. effective demonic possession of a high technology nature - the host theory (as intermediary, as energy source, as autonomic)

e. using human souls in alien bodies merely as a means to build up a slavery service class for aliens to use for various purposes, exploratory, sexual, labor monitoring, etc - the labor pool theory

f. using human souls in alien bodies to provide agents that can tolerate and intelligently communicate with human life not too far beyond its existing capacities, and yet still be effective linkage to aliens, colonization, and co-existence - the alien liaison theory

g. using alien bodies to host human souls as an effective means to control and transport or emigrate human souls to other planets designated to be the new home of the human souls or for purposes of injecting new vital soul energy into other developing alien civilizations that require 'enlightenment' or evolutionary infusion - the new 'Christs' or 'angels' theory

8. What is disturbingly amazing about this complex science fiction type deep dark hypothesis is that it appears to form an explanation for a wide number of previously disparate 'UFO' related claims and statements and hypotheses:

(From Top Secret/ Apotheosis (c) 1989 Nexus Seven)

a. explains mutilations as a means to gather biological materials for cloning and biological genetic engineering experiments and alien body 'production'

b. explains subjective control and deceptive conditioning practices of aliens towards abductees to effect increasing allegiance of the subject abductees, inculcate initial mental and telepathic adaptation and sensory and emotional accommodation of alien life and life forms

c. explains use by aliens and claims by aliens to be source of religions, representative of 'Christ', and the intent to 'rapture', evacuate, and transport humans to their new homes in 'the stars'

d. explains alien implantation of microscopic alien solid matter in abductees as a means to monitor and condition and record certain human soul operating characteristics, for later use

e. provides a set of alien motives for repeated human abductions in the first place, and secondarily provides an explanation for variety of different aliens apparently monitoring Earth and abducting humans and other life forms as a function of competition between aliens at the human 'fisheries' to harvest humans for various purposes

f. explains the vehement anti-malevolent statements by apparently more benevolent aliens as to the evil intentions of the malevolent aliens, and the malevolent aliens needs to corrupt Earthly traditions and religion for their own purposes

g. provides a reasoned explanation for the fact that much alien contact appears to have a large 'spiritual' component, and the evidence that aliens wish to find allies amongst earth humanity, at least on a covert and slowly developmental scale, lasting over many centuries, if not millennia

(From Top Secret/ Apotheosis (c) 1989 Nexus Seven)

Grays as Aliens who are Neutral, Neither Benevolent or Malevolent

1. Aliens desire to learn to communicate with humans - therefore alien contact activity over long periods for certain humans
2. Hybrid alien/humans are more easily able to communicate with humans - therefore genetic hybridization
3. Humans seen as 'not understandable', 'messy' on a mental level; emotions are unusual phenomena to aliens - therefore emotive and mental manipulation and covert experimentation
4. Aliens are good telepathic receivers, but very sensitive to human emotional amplitudes, and therefore will attempt to 'contain' human emotional expression so as to not be 'negatively' impacted by it - therefore explaining why human emotive expression is dealt with in a uncertain or cautious or manipulative manner by aliens
5. Aliens have highly developed mental powers, and so to human the experience of the alien amplitude of mental energy could be abrasive or destructive or overwhelming or sensed as involuntary by humans - therefore explaining alien repetitious mental communication attempts and experimentation to find a middle ground of acceptable or tolerable mediation and communication
6. Aliens may have underdeveloped or purposely attenuated emotional growth, since it was a messy arena of energy, especially telepathically, and now are wanting to engage emotive evolution and learning and humans present an exceptional theater within which to accomplish this now desired growth, or satisfy this alien curiosity - therefore explaining a possible reason for some aliens apparent insensitivity to human feelings
7. Many varieties of aliens are wanting to learn about human life, physically, emotionally, culturally, spiritually, and domains of human concern. Most life in the near universe is

(From Top Secret/ Apotheosis (c) 1989 Nexus Seven)

oriented towards the 'grays' and that species and evolutionary typing. Many are more or less able to even perceive human distinctions and issues and feelings and subtleties - therefore explaining the great number of different types of aliens and their interest in Earth humanity from both observational and learning vantage points

8. Different aliens search for resonant or suitable humans for establishing communication, effecting experimentation by law of pseudo-conscious compliance, etc.
9. Aliens have a very streamlined simplified life, biologically and behaviorally and spiritually, and humans present a 'phantasmagorical', nonsensical, disordered arena of new possibilities and concerns and energies that the aliens are curious about, even if it causes the alien's discomfort - explaining why aliens appear to find humans distasteful and intolerable; yet the aliens continue to interact with humans for learning and study purposes.
10. In the wide berth of aliens that may exist there is a probability of many degrees and nuances of benevolence and malevolence relative to human concerns and values.
11. In the wide berth of variations of alien types and species, there exists the probability that aliens span the spectrum of most non-human to humanoid to even genetically compatible with genetic engineering controls.
12. Aliens look for human suitable humans that may afford communication opportunity by virtue of:
 - a. similar thought and mental 'frequencies' and belief and other intellect related characteristics
 - b. similar or tolerable emotions or emotional states or frequencies or propensities
 - c. tolerable energy, emotional or mental, 'positive' or 'negative'
 - d. open mindedness or open heartedness or common interest of human for interaction

(From Top Secret/ Apotheosis (c) 1989 Nexus Seven)

e. humans exhibiting highly interesting growth activity on physical, emotional, mental, intuitive, or spiritual levels

f. humans who have had previous records of alien contact, and therefore are considered 'safe' for communication for various reasons; e.g., are energetically conditioned, predictable

g. humans are remote or physically isolated and therefore 'safe' for communication without interference or possible violation of 'verifiable contact suppression law'

h. humans who have key opportunities or roles or 'destinies' in relation to influencing human/alien mass contact, or alien interested concerns or human interested concerns

(From Top Secret/ Apotheosis (c) 1989 Nexus Seven)

NOTES

When the Security Lid Blows How Will the Government Explain
Previous Suppression?

1. Admit wrongdoing and admit to Faustian bargains (i.e. come clean)
2. State that suppression was 'better' than martial law, the lesser of 'evils', since it was fully expected that disclosure would precipitate social, economic, religious, and governmental collapse
3. Abiding by secretly made alien/human agreement or alien edicts, which if violated could have threatened 'invasion', therefore keeping things secret kept Earth 'safe', or which if violated would severely disrupt the 'plan' or human 'evolution' which would be 'bad' and cause destructive impact
4. Buying time to attempt to prepare alien presence adaptation packages for humanity, for religions, for education, for government, for science, for economic function
5. Fear and uncertainty as to the best path for information and evidence release, social adjustment, and acceptance of alien presence - belief that the existence of aliens would 'corner' most people and precipitate a violent and warlike response to 'protect' Earth life and culture
6. Buying time to develop anti-alien measures so that Earth humanity would have some degree of defensive parity against alien offensives - a catch-up quick plan - to effect real war with aliens, or:
7. Alternatively, since humans couldn't really 'beat' aliens, to stage a human versus alien war (using humans in duplicated alien craft, or knowing cooperative benevolent aliens) where humans would win the war, so as to reduce chances that humans would fear subjugation, causing social collapse, or attribute godly deification to aliens

(From Top Secret/ Apotheosis (c) 1989 Nexus Seven)

Why the Government Simplifies Aliens into Only Few Types Good
and Bad

1. Acknowledgement of great variety of aliens would promote a sense of powerlessness and fear, a sense of being 'ganged up on', and loss of sense of easy insulation and safety
2. Unable to discern the varieties of aliens to any effective degree, so better to make it simple and have fewer categories than really exist, to be more 'digestible' by humans in power or humans in general
3. Reveals they made 'pacts' and agreements with possibly the wrong aliens and they resist admitting it
4. Aliens in 'pacts' or agreement and interaction with government want the government to think all aliens that exist are part of, or subordinate to the one alien group. This reduces chances government will interact with other aliens and possibly compromise the goals of the aliens with which they have a pact
5. Acknowledgement of variety supports openness and influence to create wider interaction with more races and that represents less control. On top of that, the government does not know who to ally with, even if current 'pacts' and 'allied' aliens are known to be 'malevolent', especially since aliens show fantastic ability to deceive and manipulate. e.g. the good guy-bad guy (but both really are bad) deception technique etc.
6. Before the government knows for certain who is good, bad, neutral, etc. it is better to not reveal the variety that exists. Stating variety without conclusions as to who is to be trusted and who is not will indicate impotence and inability of the government to govern humanity's relationship with the alien presence - it only aggravates the situation as being yet more 'out of control'
7. Admitting variety will induce a higher or lower degree of fight or flight response among humanity, if higher then 'out of control' anarchy, if lower then 'out of control' insanity response. Both are unacceptable in that both produce greater social confusion and unmanageability of the situation

(From Top Secret/ Apotheosis (c) 1989 Nexus Seven)

8. Admitting great variety might produce a wide range of factionalization among human social groups that would make government ability to uniformly ally humanity against or for aliens more difficult, since variety is an opening for multiple individualistic, and complex array of possible viewpoints among humans
9. Admitting to variety could produce a situation where the aliens, in their deceptive capability, could deceive large segments of humanity as to their 'benevolence' precisely because the government acknowledged that any aliens who were 'grays' were benevolent i.e. the malevolent grays would take advantage of this, even though possibly truly benevolent grays exist

Possible Uses of Fear by the Secret Government and Aliens

Possible uses of fear in the suppression of alien presence by the secret government:

1. Make people in the 'know' fear for their life if they were to 'tell'
2. Reduce peoples resolve to release or promote information
3. Generate confusion as to priority or value of releasing or promoting the existence of certain information
4. Use fear as a motivator to keep people allied to the government, and secondarily use fear to assist the uncertainty and inability to discern the entire strategy or truth
5. Make people 'understand', i.e. get through to them using fear as a inculcation medium
6. 'Load' information to cause paranoia development/response, to be fearing even that which does not exist - getting people to imagine all kinds of horrors, fates, nastiness about the government or aliens etc. as an expected consequence to their releasing information or following certain lines of inquiry

(From Top Secret/ Apotheosis (c) 1989 Nexus Seven)

7. Induce fear by aperiodic injection of threat to effectively have people gradually or suddenly lose their sense of 'sanity', 'spiritual center', 'security of home', 'freedom', 'privacy' etc.

Possible uses of fear by aliens to motivate or control target humans and human groups:

1. To disrupt security of current belief system and sense of safety in physical, mental, emotional, spiritual domains of concern
2. To induce a sense of powerlessness and thereby produce submission and effective 'paralysis' of human action that could threaten the alien(s)
3. To see what effects and behavior are consistent with fear in observed, targeted subjects - i.e. learn about effects, causes, impacts of fear in humans, an experimental 'see how they run' usage
4. To use fear as a medium to impress new conditioning and programming to take root at a deep level
5. Use of fear can motivate target subjects towards new target beliefs and attitudes and thoughts - i.e. promote 'understanding' in a forced, controlled emotive manner
6. Fear can effect profound enough change in mental state and dynamics so as to reduce the sense of available choice and empowerment to such a degree that, beyond mere increased pliability of the target subject, the desire of the subject to escape the anxiety and fear 'energy' or 'frequencies' will translate into a desire to obviate fear through transmuting the emotive energy into its antithesis, a sense of belonging and safety, thus fear is usable as a covert emotional allegiance and association induction technique
7. Fear is more readily predictable, controllable, and functionally effective for alien purposes than human emotions such as anger or love or indifference or hurt

(From Top Secret/ Apotheosis (c) 1989 Nexus Seven)

Alien Spiritual Deception Strategem Revisited

Humans have spiritual characteristics that are unique to humans, and humans have relationships with aspects of their own being or entities and beingness beyond themselves, such as a higher self, god, goddess, guides, etc, which all are NOT alien. This is natural evident characteristic of human existence and evolution and spiritual development as souls in physical bodies.

Aliens who are malevolent would find it possible to manipulate the human natural evolutionary and spiritual characteristics for their own purposes, and the most obvious means to effect this manipulation would be to attempt to divert human spiritual development, subvert it in a manner to allow greater alien control of human spirituality and spiritual power. The clearest means to effect this subversion would be to produce an exteriorization of spiritual developmental relationships that humans normally evolve, away from the natural interior, internal spiritual course of development. This exteriorization is best effected by setting up a singular or multiple embodiment of an exteriorized version or facsimili of what human relate to previously only within themselves or within all things and no particular exclusive agent or 'go-between'. This 'go-between' strategy if effected as follows:

a. get people only to reference spirit through a particularized formal embodiment of spirit, for instance a 'Jesus Christ', a 'Krishna', a 'Mohammed', a 'Confucius', a 'Buddha', etc.

b. have this spirit appear and speak and perform actions and statements that are closely consistent with what humans believed previously on an internal basis or on a non-specific basis. Inotherwords, get people to mistakenly ID this embodiment as the true manifestation of what previously was only 'within' or 'nonspecific'

c. over time and ages, based on the now exteriorized specific embodiment relationship patterning that has been achieved, slowly

(From Top Secret/ Apotheosis (c) 1989 Nexus Seven)

alter and manipulate and change the characteristics of that 'spirit' embodiment to serve the malevolent alien purposes or goals, so that people will 'buy' periodic staged appearances of 'angels, gods, mother marys, saints' etc as the 'real spirit' becoming manifest to 'communicate, be saviour, establish exclusive 'dominion', and reinforce allegiance. These staged appearances are of course alien agents acting out a role that meets people's expectations

d. with the exteriorization of spirit embodiment 'character' and 'person' process sufficiently reinforced, have the agent promote that it will 'do it for you', 'take care of you', 'save you', 'forgive you', 'allow you passage into heaven' only through them of course, all of which effectively removes and dis-empowers people's personal sovereign relationship to their 'god' within to only function as a relationship THROUGH the agent

e. this process reduces the chances that human spiritual development and empowerment will occur in a manner that is 'out of control' from the point of view of the aliens

f. this process creates a means whereby the aliens can easily, with voluntary and eager subjects, inculcate alien chosen imprints, conditionings, programmings at a deep level since spiritual issues form the core of human conscious power and growth, thus

g. providing aliens with a means to surrepticiously pre-empt human spiritual empowerment that the aliens might perceive could be used against them, or alternatively provide aliens with a means to gather and use human spiritual power to their own ends, which aliens have not really developed for themselves i.e. a parasitic spiritual relationship

h. this may be consistent with alien standard species control approaches, which they may even be subject to themselves, e.g. the worker bee/one queen bee hive relationship

(From Top Secret/ Apotheosis (c) 1989 Nexus Seven)

i. this allows aliens to have a most powerful means to use human religions to control and 'play with' and subjugate and experiment with OTHER ALIEN races and groups who are ignorant of Earth religious contrivances. The key effect that is perpetuated is the 'singular exterior savior' that corrupts individual conscious being's empowerment and individualistic spiritual dominion of ones own life and reality. This can possibly therefore be an effective use of Earth and Earth religions as a galactic level effective control tool and humans are the unwitting agent pawns in the propagation of the fundamental deception and lie of exteriorized exclusive character of spirit. 'Only through me can you be saved'. Thus human are only a unwitting player in an inter-alien game of power and control via this religious saviour ploy.

The Non-interference Law Hypothesis Relating to Aliens
Contacting Earth

1. Non-interference with existing developing intelligent cultures and civilizations (a 'species') on planets on which the alien is not native
2. Only contact and interact overtly as the culture and individuals consciously request it with clear view of the range of consequences as possible to be comprehended by the culture or individuals
3. No interaction if it will disrupt or disturb natural mental, emotional, physical, or spiritual growth of the species, culture and associated individuals
4. If contact occurs, the impact of such contact must be attenuated as much as possible insofar as it may impact the larger influential context of the species unaided, and therefore 'natural' evolutionary course
5. Species can be observed for learning purposes, and limited, isolated interaction may occur, so long as this activity does not trigger an eventual cultural impact, at least as regards to attribution of the cause or real source of the external influence

(From Top Secret/ Apotheosis (c) 1989 Nexus Seven.)

6. Interference and intervention are only permitted, and then only in a minimal and covert basis, when the species actions are within standard prediction thresholds of impacting the surrounding space domains in a 'negative' manner. i.e. causing interference with other life beyond the species inhabited planet time-space itself, whether species is aware of the probable 'negative' impact or not
7. Each intelligent conscious being as a species and as an individual hold inalienable right to determine their own course of evolution, whether positive and generative or negative and degenerative in any realm i.e. the fundamental axiom of free will and sovereign self determination and choice

Exceptions to the General Non-interference Law

1. If individuals or groups within a species have previous relations via common ancestry, soul migration, common mental or emotive or spiritual resonance or goals, which commonality is relatively equivalent in developmental evolution
2. If planetary body had habitation by alien species prior to the current planetary resident species and such new habitation is not expected to produce degradation of other resident specie's course of evolution and free will relative to such course
3. If species existence as a whole is (albeit now distant over time) is the result of the now contacting alien species, although possibly no longer genetically compatible, yet still related and the alien species has some historical responsibility for the development or existence or culture of the resident species
4. If individuals or subgroups within the species request contact and interaction and such contact and interaction can be relatively contained to the individual or group or section of society and not 'contaminate' or

(From Top Secret/ Apotheosis (c) 1989 Nexus Seven.)

become attributively impactful beyond that individual or group

5. If species action threatens life and planetary civilization beyond themselves, then if no other viable alternative exists to intervene or stop the actual (i.e. probable, not just plausible) threat , then overt intervention activity by the alien species can occur
6. If species actions and course represents a quantum trans-species evolutionary opportunity or opening or great value to other civilizations or the contacting alien species, and such contact will not inhibit or distort the fundamental growth phenomenon or its supporting milieu, then contact is permissible
7. If required to 'save' or 'recover' or 'salvage' species elements due to species internal destructive or other alien destructive intervention action in relation to possible positive activity detailed in 6. above

(From Top Secret/ Apotheosis (c) 1989 Nexus Seven.)



The Sirians

A lot about the Sirians has been detailed in a book called *Cosmic Trigger*, by Robert Anton Wilson. There are also other sources of data. The picture below is essentially correct, including the eyes and the symbol, but the face needs to be depicted as being a little wider. The symbol is essentially right. Underneath the body suit you will find the short blondish hair.

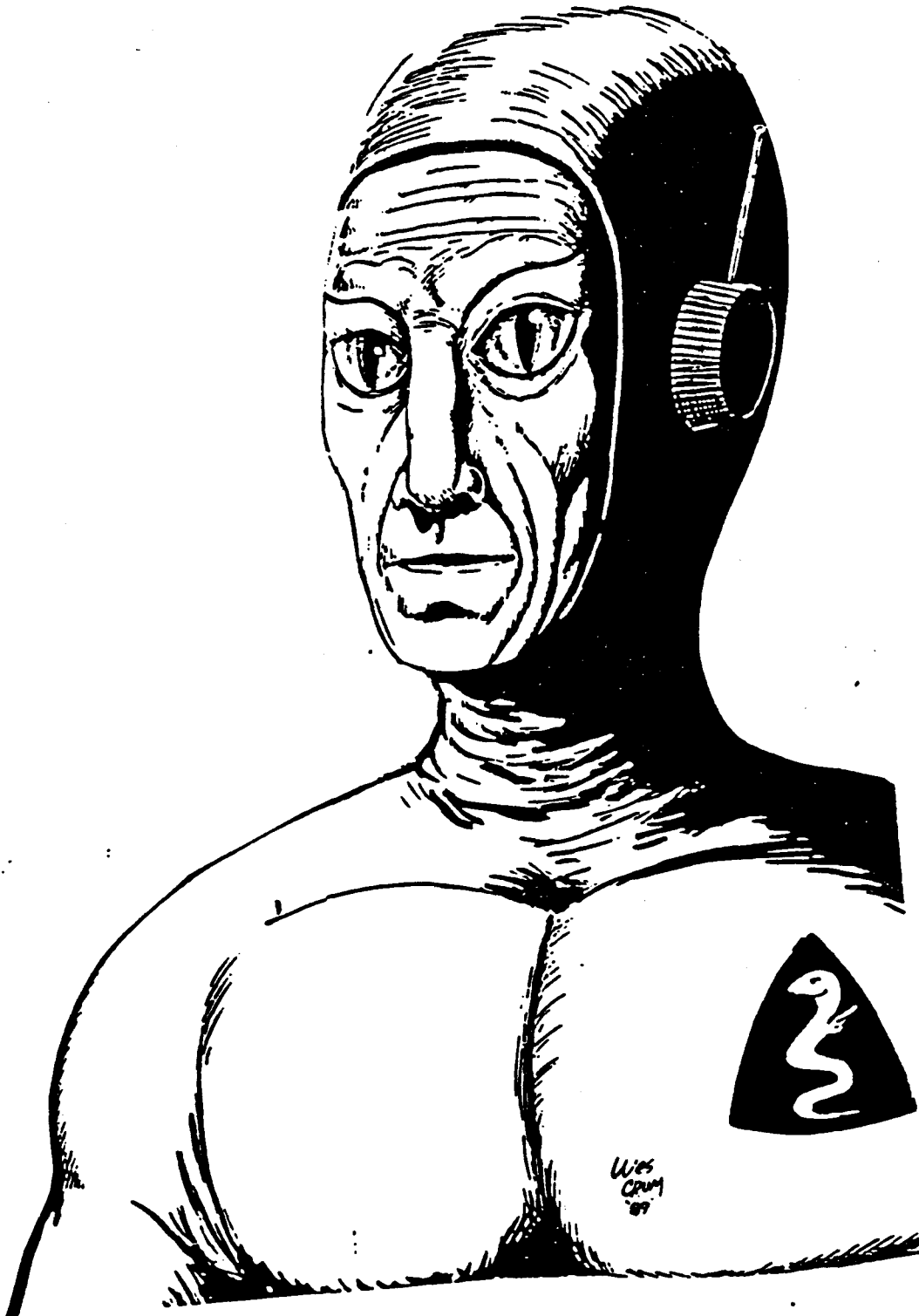

**The Case of M.P., Las Vegas, Nevada
(c) 1991 Val Valerian**

Brief Overview

The continuing situation with regard to M.P., a twenty year old woman in Las Vegas, has brought many interesting factors to the fore. Her first abduction occurred when she was five years old in December 1975. She has experienced over 400 abductions since that time, an average of two a month. Around 1987, she found that she was able to retain more and more memory of the activities. She is also an excellent artist with a photographic memory. There is sufficient evidence that she has been on various craft and she has also been taken to underground facilities in the mountains in Arizona and under the desert near Paradox, Nevada. The woman has had very limited exposure to UFO related data and is able to recall her experience without the use of hypnosis. Initial checking of the roof of her mouth revealed the tell-tale double needle marks indicative of several implanting procedures which deposit devices near the pituitary gland area. She has been subjected to processes using equipment for Reichian programming.

(see illustrations elsewhere in report)

The Arizona Site

The exact location of the site in Arizona has not been determined other than its location in a mountain range. The facility has been described as very large. She was taken there in 1987. Procedures experienced there were more involved than those experienced in Nevada or on board the craft. The facility was generally described as a laboratory-type facility. It was noticed that there were rows of inculcation bars (see Matrix II, pages 328 and 329) along the ceiling and periodically along the floors of each area in order to keep humans in the facility docile. A side effect of this tranquilizing equipment is that the emotional response to whatever is perceived is highly muted. She was allowed to walk around at one point and came face to face with a thin, female grey-human hybrid in one of the hallways. Evidently, the hybrid had never seen a human. They just stood there and stared at each other until one of the Sirians led her away. There were what appeared to be some type of computers in the lab area where she was. The mind amplifier chair was used in an effort to stage various scenarios in an attempt to capture her attention coupled with strong emotion in order to facilitate programming. It appears that foreknowledge of the operating principles of this equipment adversely affects the outcome. This is why the usage of this equipment has been revealed. The device is also used to suppress memory. There has been only one trip to this specific facility to date.

The Nevada Facility

The Nevada facility is located near the Paradox area. She was also brought to this facility in 1987. The facility is not as large as the one in Arizona. Reichian programming devices (again, see illustrations elsewhere) were used on her in attempts at programming.

The facility is generally described as one oriented toward genetic work. Large cylinders containing amber, pink, and light-blue fluids were noted. These cylinders appear to be similar to those detailed in Matrix II. All cylinders contained humanoid forms. The cylinders containing light-blue fluid contained forms that looked human. The others contained hybrid/genetic variant humanoids. The last time she was brought to this facility was on January 22, 1991, where they attempted to get her to agree to not revealing data, as the Sirians were aware of her detailed interaction with us. She refused.

The Sirians said something to the extent that she was "affecting the balance in the Confederation". If that is so, then we're certainly all for it. Upon her return she discovered that she had some pain on the right side of her abdomen.

At this facility, she saw Sirians, Greys, and in another part of the facility she saw what appeared to be US Military members. There were other beings there that she described as "light beings". Her description of them was that they had a humanoid form but there were no details in the form - it just emitted a light:



In view of the current state of knowledge, it is thought that these were beings of at least 5th density. The beings hovered around and monitored the Sirians and Greys all during her stay at the facility. The human military at the facility wore black uniforms.

Other General Information

All of her abductions that have featured interaction on a ship have included three specific Sirian males. A Sirian female would be there on occasion. Accurate drawings of these specific beings are elsewhere in this report. These same specific beings have been seen since she was first abducted in 1975. Any abductees who read this are encouraged to report interaction experiences with these specific beings to us in an attempt to establish patterns and other areas of operation. Interactions with specific equipment in this report and the Jan 1991 Krill Report should also be forwarded to us in order to allow a determination of the scale of the usage of this equipment. As always, confidentiality of identity will be respected.

Comments About the Craft Used

All abductions have involved use of the ventila-type craft shown in the illustration. Both types of equipment mentioned in this report are in use on the craft as well as under the ground.

The craft has also been seen in non-abduction related incidents from the ground in June 1990 in California and in August 1990 over Black Mountain in the Las Vegas area.

TRANS-ATMOSPHERIC CRAFT IN USE BY SIRIAN-GREY GROUP ACTIVE IN ARIZONA AND NEVADA
As of January 22, 1991

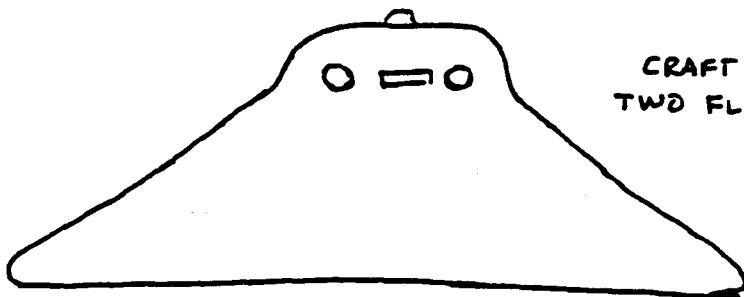
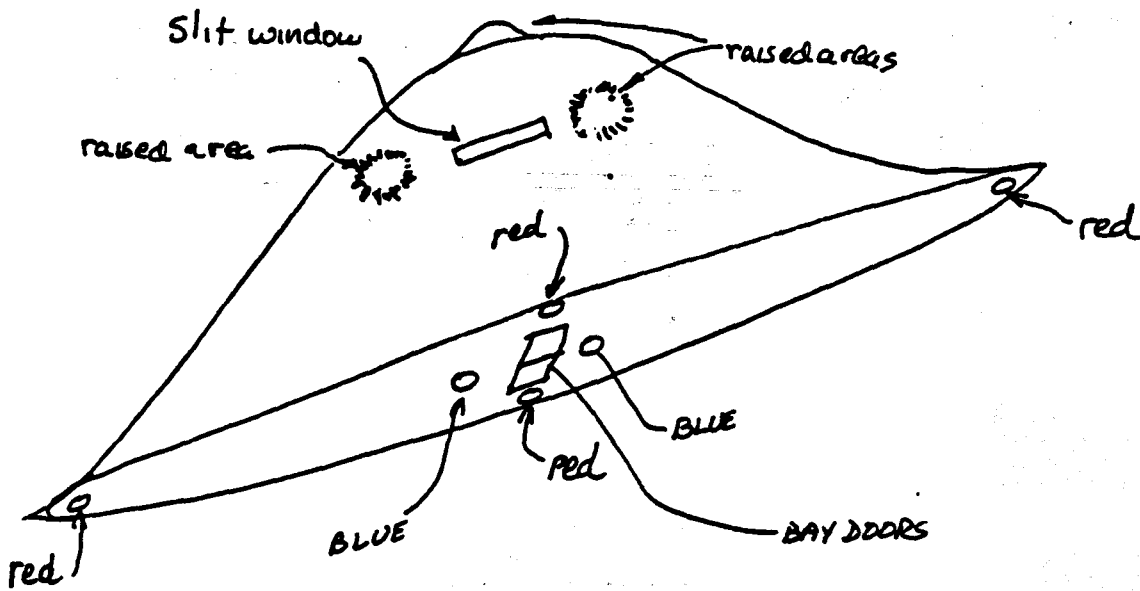

SIDE VIEW

THE SIRIAN MALES:

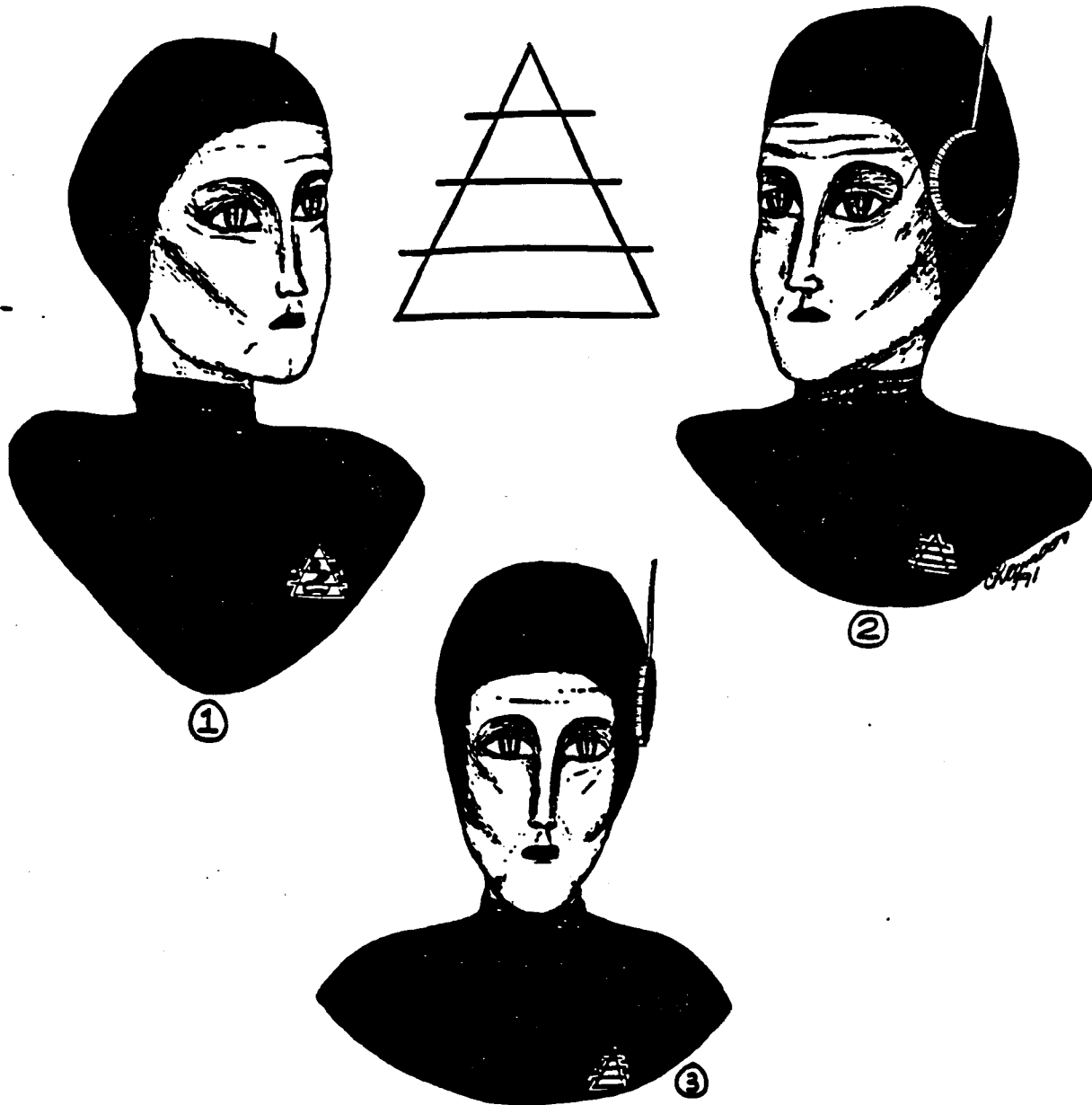

Sirian 1: "Had dominance over the other two. He was very aggressive to the point of being mean."

Sirian 2: "He was generally even-tempered, except when he got upset. Appeared to work almost exclusively with genetics."

Sirian 3: "He worked mainly with the brainwashing equipment. He didn't show much emotion at all during the experiences"

Note: All the above individuals wanted M.P. out of there when she started doing the high C tone.

SIRIAN FEMALE

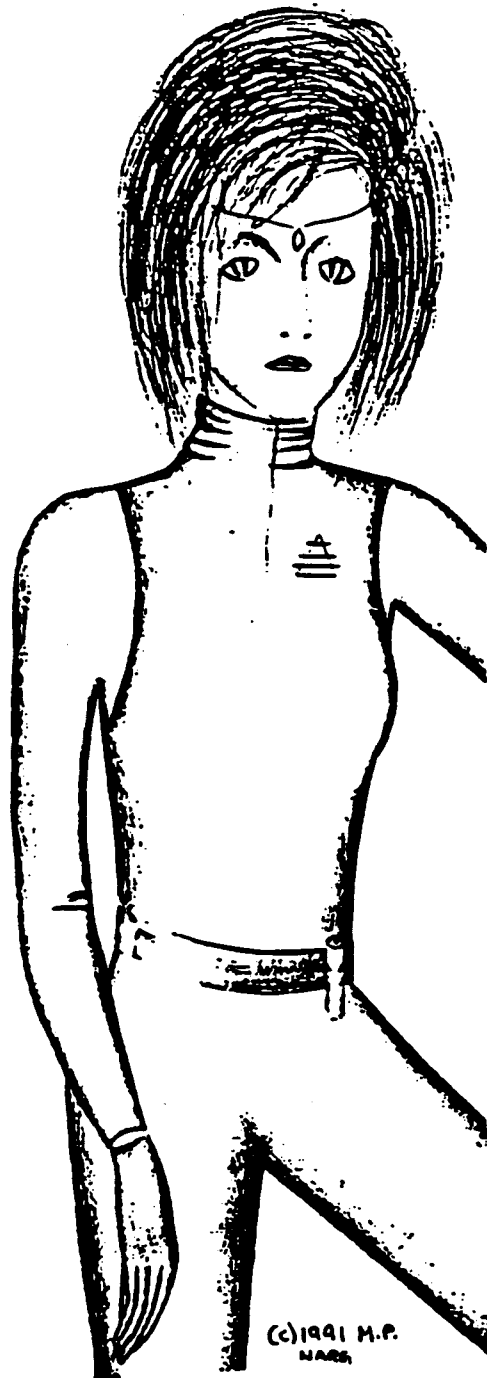

Extremely Accurate Drawing of Specific Sirian Female encountered on multiple abductions. The symbol on the left breast is indicative of interaction with underground facilities. The uniform was blue. Symbol type II.

Variations Noted in the Insignia

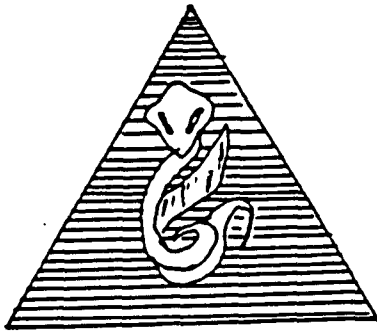

①

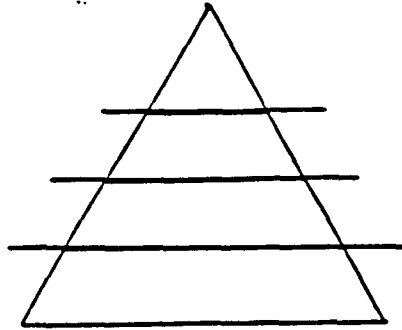

②

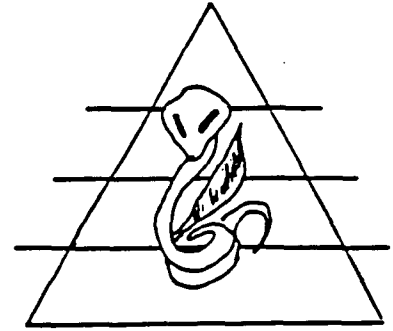

③

Note: Insignia 1 has also been noted on Reptilian species. See Leading Edge No.20, page 104, which contains Krill Report No.2. The general configuration is related to the Orion Confederation.

Fourth Variation Insignia with no parallel lines. It is seen on personnel having no direct contact with underground type operations. Seen in the Herbert Schirmer case and by others:

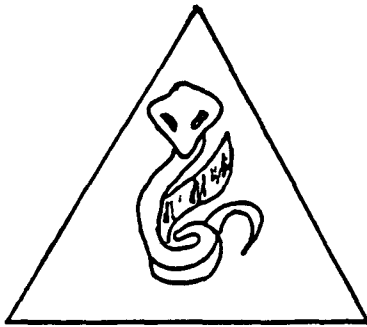

4

Fifth Variation Insignia with parallel lines stopping at the triangle. Used exclusively by humans who work in alien type environment; military & civilian:

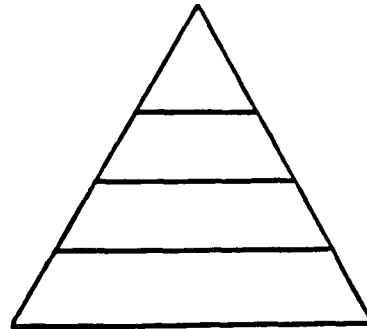

5

Descriptions of the Sirian Uniforms and Insignia

- Sirian Male No.1: Wore RED uniform with Symbol 3. 5'4" tall.
- Sirian Male No.2: Wore BLACK uniform with Symbol 2. 5'7" tall
- Sirian Male No. 3: Wore BLACK uniform with Symbol 2. 5'0" tall.
- Sirian Female: Wore BLUE two-piece uniform with Symbol 2. 5'6" tall.

A Reticulan Entity as Drawn by Wes Crum
Based on Witness Descriptions



Reticulan

WES CRUM '77

Orion Grey Type 1

These Orion Greys are about seven to eight feet tall and have what you would call an insect-base to their genetic makeup. They have no external genitalia. They are extremely aggressive toward humans.

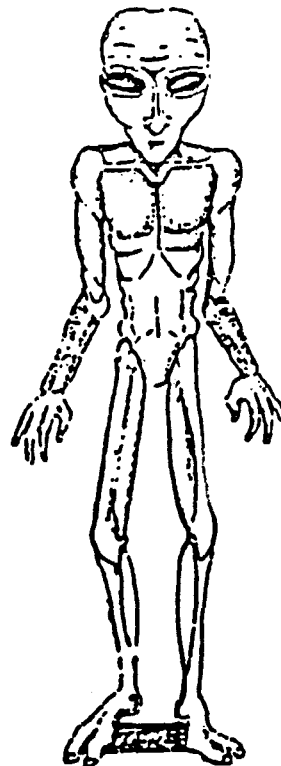

Zeta Reticuli Greys

The Zeta Reticuli Greys also have an insect-based genetic system and are about 3.5 to 4.5 feet in height. They have no external genitalia. They are less aggressive toward humans than the other Grey species above.

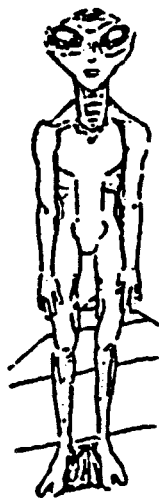

Orion Grey Type 2

These Orion Greys are between six and seven feet tall and have external genitalia.



Orion Group: Tall Blond Humanoid

These humanoids are about six feet tall, typically with long blond hair. Their eyes are typically blue with large oval pupils. They, with the others, participate in activities at underground facilities.



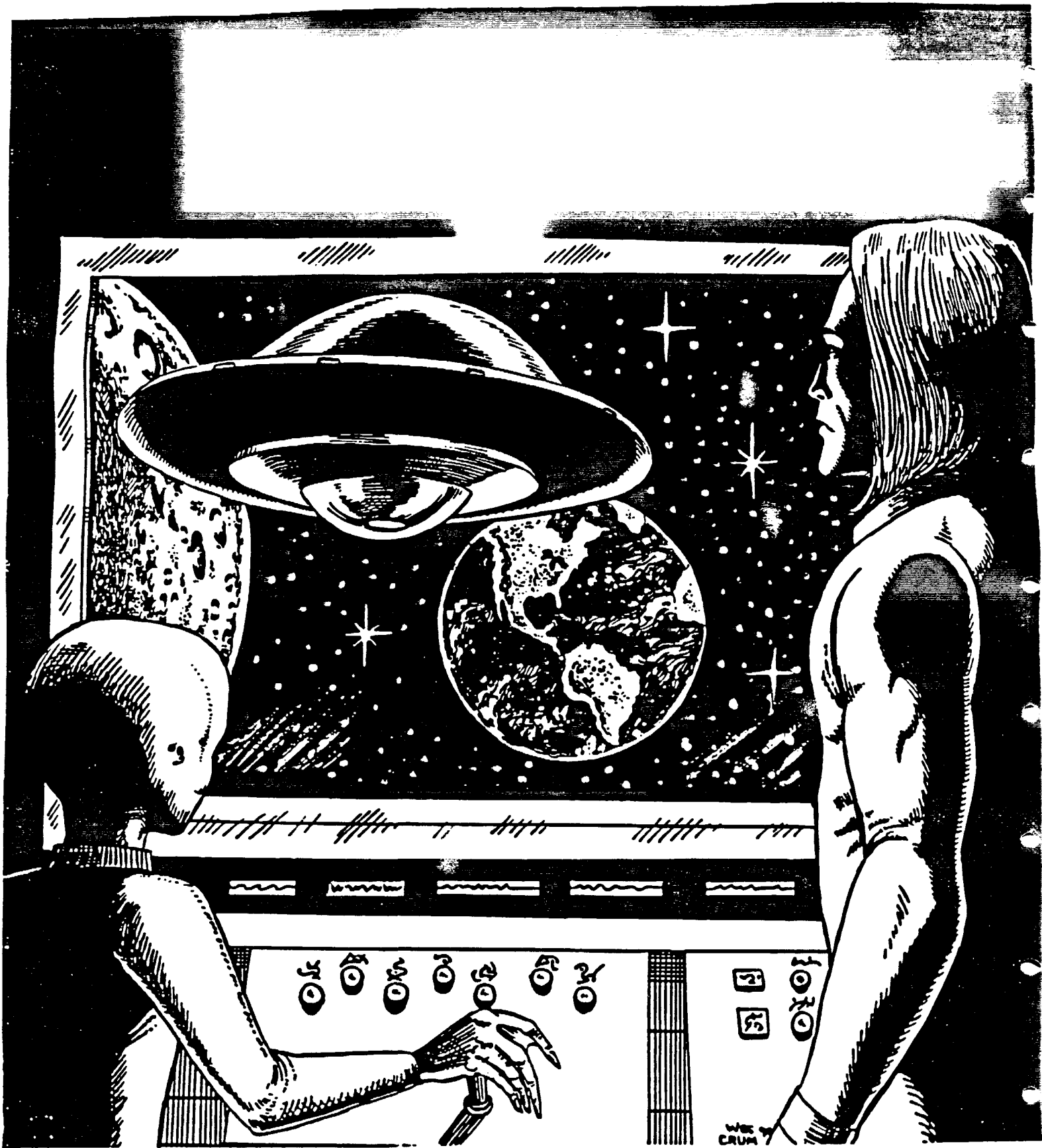

THE GREYS



Since the primary species involved is that of the Greys, we will concentrate on that species. Over the last several years, researchers have unearthed plenty of evidence that:

- o The United States made one or more agreements with a species described as the tall Greys, and has agreed not to interfere with alien operational plans in trade for technology. Agreements made in 1934, 1964, and 1972.

- o The large Greys use smaller cloned big-headed Greys to perform abduction and examination work. It is these Greys that abductees see most of the time.

- o The Grey clones are also performing biological work which necessitates the termination of various species on the surface of the Earth, which is not governed or protected under the treaty made with the US government. Underground installations are the only sovereign areas under the treaty.

- o Biological products are gathered for other genetic work, which includes cloning, DNA enrichment, and cross-breeding with human beings.

- o Researchers will recall that the disk that crashed in 1947 at Roswell, New Mexico had several reptilian species on board, as well as the body parts and clothing of several Army-Air Force officers.

Symbols, Breastplates and Logos Seen by Contactees
and Alleged Significance - PLATE 1 of 2

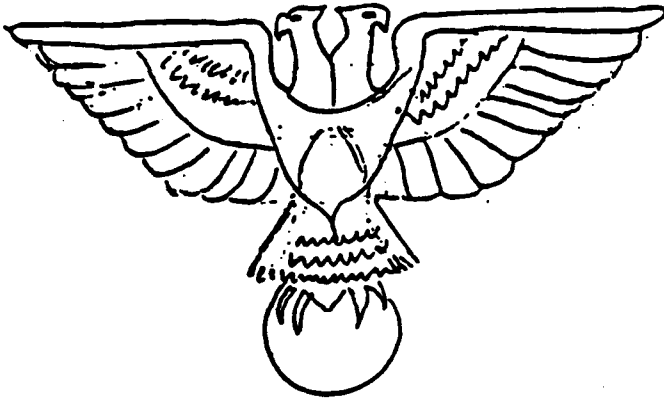

LYRAN EMPIRE

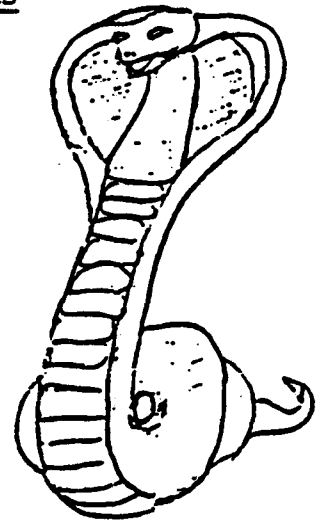

ZETA RETICULANS

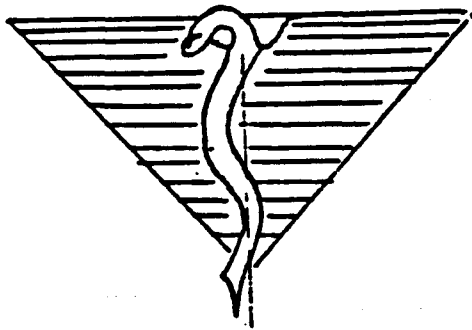

RETICULUM



RETICULUM

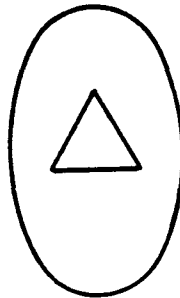

- o The Grey clones are abducting human females, both temporarily and permanently, and using them for cross-breeding in order to produce a new hybrid species that does not have the inherent genetic weaknesses of the Grey species. Research indicates that this cross-breeding is somewhat successful, and that some of the alien species that have been seen by humans are a direct result of the success of the program.

- o The Grey species in general is more on the order of an electronically based space society with a common social memory complex that allows them to collectively function as areas of group-mind. Groups of Greys are controlled from one central source being, usually one of the large Greys, a Blond humanoid, or other dominant species. The Greys also maintain the technology to create clones and implant memory from another source into the clones. Implantation technology, a trademark of Orion-based species, is routinely used as a method of social control. The United States government, specifically agencies like the CIA and the NSA, have undertaken to develop parallel technology which is a direct result of cooperation and interaction with extraterrestrial biological entities. All these methods of control are domination based and counterproductive to evolvement of individual beings.

- o For the Greys, the main motivation for the genetic work with humans is the survival of the Grey species, which is genetically damaged. Travel outside the 3rd dimension also bridges the human concept of time. Some species, such as the Essessani, claim that they are the result of hybrid genetics that are being performed at this time. We're seeing a lot of hybrid species, as well as species in different stages of their own evolution.

- o The Grey species is not based on individualization or being an individual entity. For entities maintaining a group mind set (social memory complex), individualization seems to cause a great deal of random energy loss. They were initially fascinated both with human individuality and the human emotional spectrum, which they can perceive but apparently do not comprehend what it means (to the human). They do understand the concept of bonding, but only intellectually in terms of bonding (between human mother/ ovum source and an alien cross-breed child) that will serve to contribute to the survival of the cross-breed. They recognize the need for it in the child in terms of survival. The Grey mind-set and abilities/weaknesses will be discussed later in this work.

- o Species objectives appear to be founded on a rigid domination survival-based social order, where their "religion" is science, their social structure is geared to obedience and duty, their military concepts are grouped around conquest, colonization, and domination through covert mind control programs.

Symbols, Breastplates and Logos Seen by Contactees
and Alleged Significance - PLATE 2 of 2

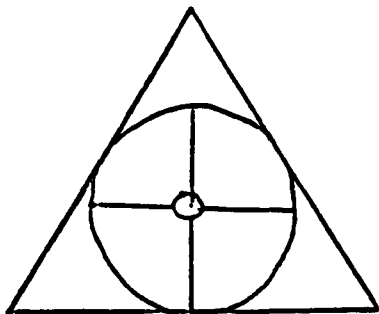

SIRIANS



PLEIADIANS

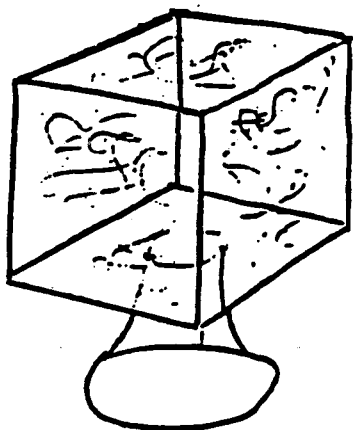

ORION GROUP



SERPENT RACE

Vertical text on the right side of the page, possibly bleed-through from the reverse side. The text is mostly illegible but appears to be arranged in two columns.

- o The way the Greys seem to locate subjects for their work is more or less a result of their efforts to find human entities who vibrate in resonance (or a harmonic thereof) to their vibrational complex. One of the human aspects that promotes this resonance is fear, which almost amounts to permission from the Grey standpoint.
- o It has become apparent that abductees are also being trained on alien equipment for some future time. Researchers have pegged that time between 1990 and 1996, based on regression sessions involving hundreds of abductees over the course of several years. No clinical success has been achieved in pegging exact dates, due to the strength and level of the mental block which is imposed on the abductee. Very often memory blocks are tied in with the survival instinct of the human, which makes the block extremely hard to penetrate.
- o The Grey species can tolerate radioactivity at levels humans cannot stand. The apparent reason for this involves species exposure to a nuclear interchange in the distant past which promoted degradation of their genetic structure. This aspect is noted in terms of where the Greys frequent in the United States, especially base areas, which are near nuclear facilities, waste storage, etc. Animal mutilations are highest in these areas also. A connection? Yes.
- o Most atomic structure in this localized sector of the universe maintains an clockwise spin. For some reason, the Greys/EBE's are sensitive to materials with a counterclockwise spin . It has been stated by some researchers that sugar and the AIDS virus have a relationship with left- and spin material.

Note: When one of the Greys dies, its implant serves as a focusing device for retrieval of the body. There have been several cases where Greys have died in front of witnesses and the bodies have been 'beamed' away.

Grey Objectives

Their religion, as it were, is science. They appear to divide this into physical, spriritual and sociological objectives in terms of planets they invade and dominate, as they have dominated Earth for thousands of years. Their basic game appears to be to use nullification and domination to control the leaders of various targeted civilizations. They accomplish this by taking out the leaders and replacing them with entities they can control.

The Earth

This planet is somewhat unique in that it has a broad spectrum of entities existing on many different density levels. Aliens who have a motivation for conquering a planet such as Earth locate beings who vibrate in resonance with their vibrational frequency, which is on a negative level of spirituality. The people that the Greys influence are commonly told that they are the 'elite' or 'chosen ones' that will rule. Earth is not under the vested control of any major group of aliens, despite the Greys, but is being victimized by a number of vested interest groups. Things are only peaceful and calm when someone is in absolute control.

The function of the 'elite' humans, as far as the Greys are concerned, are to decimate portions of the human population so that the remainder can be easily controlled. Hitler is a prime example.

Apparent Social Structure

The social structure of the different Grey species seems to be geared around their group memory complex. Abductees often relate that when they are in the midst of a group of Greys, they all seem to respond together, to one degree or another, when one of them responds. Much information has been gleaned from various communication efforts with these entities. We're learning about them.

The main operative in their social structure is obedience and duty, and it has become apparent that there are definite hierarchies within their social strutures which provide for each entity having specific duties to perform.

One by-product of their social memory complex is that any kind of decision takes a while to make, since none of the clones seem to have the innate ability to act independently of the other cloned species. This social structure has no room for "surprises",

and the "best laid plans of mice and men" can be totally wrecked if it comes into contact with anything outside its operational context.

The tall Greys seem to be less prone to the frailties of the system than do the smaller Greys.

Grey Strategies and Operations

Let this outline serve as a means of introducing the extra-systemic entities known as the Greys. The presence of the Greys is not a new phenomenon. There is sufficient evidence to show that the blond race of EBE forced them off the planet around 1051AD. They have returned.

Interaction between any two species can, on a different level, be viewed as sort of a contest or Game; all games vary in goal and purpose. The Greys are playing a Game with us - the game of Master and Slave. Humans are the Slaves. The Greys are the Players and humans are the Pieces. In order to become true Players and leave the playing field, humans must learn the rules of the Game. They must learn all the hidden rules - rules that the Greys keep hidden from Other Players that are observing the Game; these Other Players refrain from direct interference, but apparently prefer to give assistance on mental levels.

The various species of EBE generally referred to as the Greys are composed of entities which cover a broad spectrum of awareness and density.

The basic game of the Reticulans, who operate primarily at 4th density, is to use nullification and domination to control the leaders of civilizations targeted. They accomplish this by taking the leaders and replacing them with their own entities who resemble the leaders taken.

Military operations of the Reticulan species consist of colonization of unprotected civilizations for the purpose of setting up logistical supply depots, slave sources, and acquisition of potential allies.

The exercise of domination and enslavement of planetary populations is expressed as "service to self" (as opposed to "service to others ") and creates power for that group. Inherent in "service to self" is a rapid dissipation of the power of the civilization, due to the downward spiralling which is always the result of Games of Negativity and Limitation.

The atrophied state of mind these games induce contributes toward the disintegration of their social memory complex and group consciousness.

The Earth is somewhat unique in that it has a broad spectrum of beings of several density levels and race-types. It is inhabited inside, outside, and in the atmosphere in thousands of hidden little pockets and time-stream projections.

The process of conquering a planet involves location of beings that vibrate in resonance with their vibrational frequency. These located beings are then told that they are the Elite or Chosen Ones who will conquer or lead the human race and rule the world for their Grey masters. Often the located beings are physically taken aboard craft and given physical examinations, provided with implants, given accelerated data through inculcation methods that will help them serve the Greys.

The function of an Elite is to decimate portions of its own race in an effort to reduce populations to manageable limits so the remainder can be easily controlled. The Nazi-Jew scenario is a good example of the Grey modus operandi. They also controlled the Imperial Japanese Empire and are generally responsible for most aggression between human groupings on the planet.

Humans have generally been deceived into playing victim-games of negativity, self-limitation, self-denigration and destruction. The games that the Greys are trying to enforce are games of conversion and secrets, as well as hidden standards.

All activities are conducted on a "playing field" which is limited by the attention span and the scope of awareness of the Players.

Military Operations

Colonization of unprotected civilizations which are unaligned with any other group in space. They use planets for supply depots, slave sources, and biological materials. The exercise of domination and the enslavement of planetary populations is expressed as service to Self (as opposed to service to Others). It creates power for their group, but inherent in this process is a rapid dissipation of power in that civilization due to the limitations imposed by the games of limitation and negativity enforced on the popularity.

According to what research has revealed, there are certain methods and plans that have underscored the literal invasion of Earth by various Orion based species. Typical scenarios might be:

- (1) The target planet is time-tabled for invasion.
- (2) The base station is moved within range.¹

1. Interestingly enough, it appears that there is a Reptilian-based Orion scenario going on as well, with reports in the New York and London news of an approaching planetoid, due here 1990-92.

- (3) Long range telemetry devices are sent forth for surveillance to ascertain the level of development of the civilization and whether or not they have become a social-memory-complex (this could be defined as an aware society, its members generally aware of being aware, with aligned purposes, goals, programs,
- (4) Upon establishing that the planetary civilization has yet to align into a proper social memory complex (its members being aware that they are aware, with aligned purposes, goals, and programs) covert operations move in with intelligence and science teams to begin an in-depth study of the planet.
- (5) Large electronic communication devices are placed in orbit or hidden on or under the surface. These devices operate on the level of mental or emotional wavelengths. When a being is attuned to the typical Orion wavelength (they resonate to service to self) or "prays for help to his God:", there are computers that answer those calls with pre-recorded messages which appear to the lesser aware being as divinely inspired messages from a deity or angels.
- (6) Leaders are approached with population control programs or solutions to survival-related problems. Leaders are convinced that they represent " an Elite " group that has been chosen "by God" to rule the populace for the good of God's empire. Look at any theocratic country on Earth and you can see this.
- (7) In the event that the leaders are hostile, emphasis is switched to the masses in order to evoke replacement of planetary rule with "elite" from the masses (who are controlled by off-planet forces).

Apparent reasons for Orion Based Operations

In accordance with "service to self" philosophy, goals are sought that will achieve more power for the "elite" or ruling class; it is important that more and more slaves be made, so that the psychic energy can be drawn off to feed the madness of the "power elite". Domination and nullification is the basis of the game of struggle and conquest. It is a stable datum to negative Orion based groups that empires can only be built and maintained on the backs of broken "game-pieces", and oiled by the blood, sweat, and tears of "worthless entities too decayed to be useful for any other tasks" and too rebellious to trust in more cooperative ventures.

A Tentative Taxonomy of Extra-Terrestrial Humanoids

The following material, compiled by George Andrews, who wrote "Extra-Terrestrials Among us", was originally seen in Matrix I. It is important enough to be transferred to Matrix II and combined with the rest of the book. George has a new book, which should come out in 1991 or 1992, entitled "Extra-Terrestrial Friends and Foes".

The information in this chapter was given to me by a lady who has experienced multiple abductions by both the types of entities described, and who insists upon retaining her anonymity. I realize that some of her statements are extremely controversial, and that the prudent course would be to refrain from relaying such explosive material to the public, since it is based entirely on unverifiable statements made by one person. However, I have now shared this with a considerable number of other abductees, many of whom feel that it correlates significantly with their own experiences, and that the information it contains is of such potential importance that it deserves a public hearing, which would be the quickest and most effective way to either confirm or invalidate it.

This is a preliminary and exploratory attempt to establish a taxonomy of extra-terrestrial humanoids. As I don't have any hard evidence to back up my statements, they must therefore be considered as speculation, though they are based on anecdotal evidence which is in my opinion sincere and truthful. The two types I am about to describe represent only a small fraction of the many types, both short and tall and of medium height, who are at present hovering above us or among us.

The first explosions of our nuclear weapons at the end of World War II sent out a signal that brought in a

veritable traffic jam of entities from many different regions of this galaxy and of neighboring galaxies, as well as from many other dimensions. Besides this swarm of newcomers, we have been visited by a wide variety of extra-terrestrial and inter-dimensional life forms throughout our history and prehistoric times. However, the following two types have not only been interacting with us since deep antiquity, but are engaged in long-enduring celestial warfare, which is also being carried out on Earth, in which our allegiance is a key factor.

The first type is the short gray humanoids with the large heads, which resemble embryos and average about four and half feet in height. They are from a solar system that revolves around Rigel. Rigel is a double bluish-white star on the left foot of Orion, about 800 light years from Earth. They have problems with their glands, particularly with their sebaceous glands, which make it difficult for them to digest food. These glandular problems were caused mainly by exposure to radioactivity during a nuclear war their race fought in the distant past, many thousands of years ago.

It is this type of humanoid that is performing most of the animal mutilations and human abductions, which has made a secret deal with our government, and which was in contact with Hitler. They derive nourishment from the glandular secretions and the enzymes they extract from the animals they mutilate, which they absorb through their pores. Our government permits such activities partially because of its

acute fear of these beings, and partially because it is under the delusion that they will give us technical information enabling us to attain military superiority over the Russians in exchange for our permitting the mutilations and abductions.

The Stealth Bomber and Star Wars technologies are being obtained from them. However, our government does not appear to realize that when it comes to the crunch the technology they are transmitting will not work as it is supposed to. It is not in their interest to give us decisive military superiority over the Russians, or vice versa. It is in their interest to keep us in a state of unresolved conflict with each other, the old game of divide and conquer.

If no animals were available, they could subsist upon gland extracts derived from humans. As a rule they do not use humans in this fashion, but they could and would in an emergency. Their attitude toward humans is to tolerate us to the extent that we are useful in raising the animals necessary for their nourishment. Despite many attempts, none of our terrestrial animals (nor their frozen sperm or ovum or embryos) have survived the long journey back to their planet.

They would not attack us with nuclear weaponry, as nuclear war would irrevocably poison or totally destroy this planet's entire biosphere, including any hypothetical human or animal survivors, who would inevitably suffer from glandular problems similar in nature to those they are

already afflicted with. They do have the ability to throw this planet off its axis.

Rigelian technology is more advanced than ours, but that is the only way in which they are more advanced than we are. They manipulate us through our laziness and ignorance.

Working under the instructions of the humanoids from Rigel, CIA and former Nazi scientists have developed and deployed malignant strains of bacteria and viruses, including AIDS. The rationale from the fascist point of view is to exterminate portions of the population considered to be undesirable. The rationale from the Rigelian point of view is to decimate the human population to such an extent that the survivors would accept open control by the Rigelians.

The Rigelians are almost entirely devoid of emotions, but can obtain a second-hand 'high' by telepathically tuning in to different kinds of intense human evolution, such as ecstasy or agony. This is not done for the purpose of sadistic gratification, as most of them are oblivious to the difference between positive and negative mental states. It is a biochemical as well as a psychological process, used as a mood-elevator.

Certain types of unusual sexual practices attract these entities like flies. It was Aleister Crowley's sexual pursuits rather than anything else which attracted these entities to him to absorb the energies released. Crowley was more effective as a medium than as a magician. Some of

his diatribes about trampling the weak were due to telepathic linkage with entities who were obtaining a vicarious 'high' from the intense emotion involved in such diatribes.

The humanoids that have been nick-named 'Swedes' are on the average between six and six and a half feet tall. They are from a solar system that revolves around Procyon, a binary yellowish-white and yellow star system that rises before Sirius in Canis Minoris (in the body of the Lesser Dog), about 11.4 light years from Earth. They are from the fourth planet in orbit around the Procyon double star system. The tall blond humanoids from Procyon and the short gray humanoids from Rigel have been enemies for many thousands of years.

The tall Blonds from Procyon have a benign attitude toward humanity, except for their strong disapproval of our inhumanity to each other. This strong disapproval is further intensified by our government having made a secret alliance with their hereditary enemies, in order to obtain even more destructive weapons systems than those already in existence. Our government is not interested in negotiating with the Procyonians, as they would not provide us with weapons systems.

The tall blond humanoids carried out experiments that involved both artificial insemination and interbreeding with primitive humanity. The desired result was to combine the larger brain capacity of the tall Blonds with the lung

already afflicted with. They do have the ability to throw this planet off its axis.

Rigelian technology is more advanced than ours, but that is the only way in which they are more advanced than we are. They manipulate us through our laziness and ignorance.

Working under the instructions of the humanoids from Rigel, CIA and former Nazi scientists have developed and deployed malignant strains of bacteria and viruses, including AIDS. The rationale from the fascist point of view is to exterminate portions of the population considered to be undesirable. The rationale from the Rigelian point of view is to decimate the human population to such an extent that the survivors would accept open control by the Rigelians.

The Rigelians are almost entirely devoid of emotions, but can obtain a second-hand 'high' by telepathically tuning in to different kinds of intense human evolution, such as ecstasy or agony. This is not done for the purpose of sadistic gratification, as most of them are oblivious to the difference between positive and negative mental states. It is a biochemical as well as a psychological process, used as a mood-elevator.

Certain types of unusual sexual practices attract these entities like flies. It was Aleister Crowley's sexual pursuits rather than anything else which attracted these entities to him to absorb the energies released. Crowley was more effective as a medium than as a magician. Some of

capacity and respiratory system of primitive humanity, better suited to this planet's atmosphere. The sudden emergence of Cro-Magnon man was the result of their intervention. A large proportion of present-day humanity is descended from this mixed ancestry.

The Procyonians have continued to cross-breed with us at many stages of our evolutionary development, and this type of activity still goes on at the present time. They are trying to straighten out and correct the somewhat scrambled results of their earlier interventions. We turned out to be physiologically acceptable, but are as yet considered to be a psychologically unstable and immature species.

The Rigelians also perform genetic experiments on us, but are hampered by the extreme degree of difference between our species, and are not capable of interbreeding with us directly.

The Procyonians tune in on us telepathically to vicariously experience our emotions, as the Rigelians do, but the Procyonian motivation is to trace and fully understand the biological and psychological ramifications of these emotions. Their motivation for breeding with humans is to tune up the frequency of our species, in order to help us to help ourselves. Their concern is for the well-being of all forms of life, not just humanity. The entire biosphere will benefit if we fulfill our positive potential,

instead of self-destructing and destroying our planet's biosphere in the process.

It would be a mistake to count on them to clean up the mess we have made of our polluted planet, or to bring peace by dismantling our nuclear weapons. It is up to us to solve the problems that we have ourselves created. No one else will do this for us. Humans tend to make either Christ-figures or Satan-figures out of extra-terrestrial or inter-dimensional visitors, in order to absolve themselves from the responsibility for their own actions. This is a self-defeating strategy that does not work, that never has and never will. Awaiting a savior from the sky is a recipe for disaster. If we each do our very best to tilt the balance toward the continued improvement of our species and the quality of life on this planet, we stand a chance of resolving the immense problems we are faced with, but there are no guarantees. Christ-consciousness should not be confused with Christ. It is easy to kneel in awe. It is far more demanding to develop the full spectrum of awareness that is Christ-consciousness. It is up to us to shape our own destiny.

Although the Procyonians are from a specific physical place within our galaxy, they can also travel through time and between dimensions. The Rigelians do not have these abilities. The Procyonians frequently use mechanical vehicles for transport, but are not exclusively dependent on them (as the Rigelians are), since they can also use thought

3

processes to teleport themselves physically. Our own legends indicate that a few rare and highly developed human adepts have occasionally acquired this ability. No mechanical vehicle can equal or exceed the speed of light, but such teleportation can. The process requires de-materialization and re-materialization.

The name by which the Procyonians call their home planet translates into English as "the home of those who travel through time". The stone circles and megaliths constructed under their supervision in deep antiquity were geocentrically and celestially aligned to give access to time travel, thereby serving as time portals. It was also possible to acquire access to other dimensions through them.

In order to extricate ourselves from the covert alliance the CIA had made with Rigel, without our knowledge or consent, we must first regain control of our government.

At this point Khyla of Procyon, the Watcher who transmitted the information contained in this chapter, intervened to make the following statement:

"Tyrants have been defeated many times on many planets, in countless solar systems and galaxies. How strange it is that as soon as one tyrant of any species is thought to be banished forever another always, but always, takes his place. The idealistic revolutionaries who defeated King George III in America went on to oppress the Indians and Blacks. Many of those who fought most courageously against the Axis powers of fascism later became fascists themselves,

as is demonstrated by the present plight of the Palestinians, Afghans, Chileans and Nicaraguans. Yes, you must try to regain control of your government, but if so much as one individual involved in this process has not first gained control of his or her selfhood, it will be for naught. One can never defeat or gain control of anything but oneself. Those destined to oust the Rigelians must always keep track of the state of their selfhood, and learn first to defeat within themselves the essence of that which is tyranny. Through this type of awareness, they will know when to act and when not to act. Through understanding a hostile entity to be but one of the Ineffable's countless facades, it loses its power over you. Through the ability to wisely perceive a hostile entity, you may gain control of it. In overcoming the Rigelians, one must take great precautions not to become oneself the enemy. Certain levels of conscious existence will always be subject to tyranny. It is the nature of the vibratory rate. Gain control of yourself by ceasing to try to control. Anything you try to conquer, you only make stronger. Lao Tse was one of our best pupils. Although he was not of human origin, Padma Sambhava evolved to such an extent during his life on earth in human form that his development surpasses ours, as our development surpasses that of ordinary terrestrial humans with their three-dimensional awareness. We have multi-dimensional awareness, but the awareness of Padma Sambhava is omni-dimensional. He transmits to me much of what I am

telling you. We do not align ourselves with the terrestrial hierarchy that formed around the tradition he left behind him, but we do maintain communication with his very much alive omni-dimensional presence. Such communication still remains available to terrestrial humans who seek it with whole-hearted single-pointed devotion, either within or outside the context of the Mahayana Buddhist hierarchy. The Tibetan legends about the sacred treasures concealed by the lotus-born Root Guru for humanity's future time of greatest need refer to physically real objects of power whose retrieval will be essential to humanity's survival in the forthcoming apocalyptic struggle. They cannot be retrieved until Tibet is returned to the Tibetans. The Scandinavian legends concerning Odainsakr refer to these same objects. The Watchers have always been here. Those who hear or touch or are touched by them will evolve themselves into Watchers. All cultures go through a stage of high technological achievement prior to learning that everything they get their machines to accomplish can be done with pure thought. The Watchers need no tools to contact any mind. Humanity as a collective entity may create whatever destiny it chooses for itself. These paths include enslavement, nuclear destruction, and peaceful flourishing growth. Whatever path humanity selects is right for it. Souls do not cease to exist. If this planet is destroyed, they will go on to learn elsewhere. If you are free from the fetters of illusion, no force can harm you. To escape, one merely

accepts. To accept is to transcend. When you know unceasingly that even in a nuclear holocaust both antagonists, the battle itself, and the perception of that whole event is the oneness of the Ineffable in a dance with its shadow, you will no longer need to exist at this level. The entire cosmos is but the manifestation of the mind and light and energy of the one Ineffable. War is neither right nor wrong. Wisdom can be gained on any path. Even that which seems certain folly is only a play of light and shadow. There are countless ways to learn. It is merely more pleasant to select a curriculum that is less prone to being painful. If an individual or a collective entity elects to learn through suffering, so be it. There are less traumatic ways to gather understanding. The Rigelians and the CIA have put in motion the potential for a rather drastic mode of learning. This can be altered at any time. Whatever it may be, the outcome is always as it should be. However, this does not mean that we should sit back and take no action."

The ancestors of the short Grays were once tall Blondes. The Great War took place. Behold the bitter fruit of victory. The Grays are a genetically damaged species. If terrestrial humans were to survive a nuclear winter, they might well look like that, several generations later. Before the great war, Rigel was a vast empire, which had been the source of most galactic seeding. All Rigelians were tall Blondes. A colony had already been established on

Procyon. The Great War was a civil war of Rigelians versus Rigelians, and lasted the equivalent of three Earth centuries.

A group of Rigelians who realized that the Great War was about to break out took off for the Procyon colony in crude, clandestinely built ships. At that time, all the sophisticated equipment was owned by the State. They were the only Rigelians to escape the cataclysmic devastation. All those who had remained on Rigel were transformed into the short Grays.

After the Great War, when the Rigelians had become the short Grays, it took them thousands of years to reconstruct their society. They were damaged not only genetically and in their glandular systems, but also mentally and psychologically. As soon as the short Grays had reconstituted a power base, they launched an attack on the tall Blonds who had escaped to the Procyon colony.

Although the Blonds of Procyon had been spared the extreme chromosome and glandular damage sustained by those who had stayed behind on Rigel, they did suffer some radiation damage during their warfare with the Grays, which was minor in comparison. However, it is this that has rendered their females vulnerable to a disease that is decimating their numbers. The mute telepathic Blonds, who do not have speech abilities, suffered more extensive radiation damage than those who retained their speech ability.

Two major wars are still in progress. The one between Rigel and Procyon is at present in a state of temporary truce, in which active fighting could break out at any time, comparable to the U.S.-Soviet cold war situation. The war between Rigel and the Sirius system is being fought actively.

Earth was seeded by the original tall blond Rigelians, before the Great War took place. The original tall blond Rigelians were the progenitors of Cro-Magnon man. It is because of this common ancestry that terrestrial humanity is of such interest to both the Blonds and the Grays. The abductees who are not returned are used for breeding purposes, and are in general treated well.

Terrestrial human females can be impregnated either on board ship or while they sleep in their homes. Males need not be manifested in visible form for this to occur.

Both Grays and Blonds have the ability to disintegrate matter into energy, then reintegrate the energy back into matter. That is how they pass through walls and roofs, and transport abductees through walls and roofs.

Grays have the ability to camouflage themselves as tall Blonds through mental energy projection. Blonds do not ever project themselves as Grays. Sometimes Blonds are physically real, but are prisoners of the Grays. The Grays must paralyze or destroy their ability to teleport through time and other dimensions in order to take them prisoner.

Just as in terrestrial warfare there are sometimes traitors, defectors, deserters and prisoners of war, so there are in warfare between extra-terrestrials. And just as in terrestrial warfare there are periods of truce, during which teams from opposing armies may cooperate temporarily on certain projects, so there are periods of truce in warfare between extra-terrestrials.

Some Blonds have high intellectual and verbal abilities, while others are mute and telepathic. The Blonds with speech abilities will respond violently if attacked or threatened, but the telepathic type will not. Both types are careful to avoid exposure, and usually encounter humans in quiet isolated places. They contact females more frequently. They may just stare and observe humans, then retreat. Blonds were sometimes mistaken for angels in earlier centuries. The Blonds do not seem to age, and consistently appear to be from 27 to 35 human years old, no matter what their real age may be.

More than one type of extra-terrestrial visitor is interbreeding with humans. The Blonds are the ideal choice to interbreed with humans of all races, because there is a common genetic ancestor. Interbreeding of humans with any other species must be carefully controlled, as humans have different immune systems than extra-terrestrials. New hybrid bacterial strains can cause disaster both ways. Blonds can infect humans, and humans can infect Blonds. Blonds may be carrying viral and bacterial micro-organisms

that are safe to themselves but harmful to humans, and vice versa.

The Grays consider the Blonds to be rebellious and unstable. The Grays try to prevent the Blonds they have taken prisoner from escaping to explore terrestrial humanity unsupervised. However, a substantial number of such Blonds have escaped and are intermingling with humans.

There are over a thousand humans in the United States alone (not counting those in other nations) who are the offspring of inter-galactic or extra-galactic beings and terrestrial humans. Of these, about two hundred know or suspect their origin.

All humans have some extra-terrestrial genetic background. If they did not, all that would exist on this planet would be flora and fauna that included but did not go beyond the apes. The clams, worms, starfish, sponges and other primitive organisms from which the entire flora and fauna of this planet evolved were deposited in the primeval oceans as the preliminary phase of planetary seeding, which should be obvious from any study of the record left in the Cambrian and Pre-Cambrian rocks.

Throughout recorded history, as well as during prehistoric times, there has been constant genetic manipulation of and interbreeding with humans, in order to breed out our less evolved simian traits. Sometimes interbreeding between humans and space beings has been a success, and sometimes it has been a dismal failure.

However, the species Homo sapiens would not exist if it had not been for this persistent genetic manipulation and interbreeding, which will continue (unless nuclear war destroys our species) until humanity fulfills its potential by learning to use its total brain, instead of a mere fraction of it.

The woman who transmitted this information to me described her contact as follows:

"Khyla looked like a tall handsome human, slender but muscular, masculine yet ethereal. He appeared either naturally or artificially to have black around his eyes, almost like kohl. His face was close to exquisite, but definitely masculine. He had a gaunt face with high cheekbones and piercing cobalt-blue eyes. He had fine blond hair that was almost shoulder-length. He had a muscular neck. His skin was pale flesh color, with a whitish overtone. It is hard to gauge his exact height because of the circumstances under which our encounter occurred, but it was somewhere between six and seven feet."

Here is some more:

"If you were a highly advanced culture about to invade a relatively primitive culture, you would not do it with a flourish of ships showing up in the heavens, and take the risk of being fired upon. That's the type of warfare less evolved mortals would get into. You would begin by creating intense confusion, with only inferences of your presence, inferences which cause controversial disagreement."

You would go to the most secret and powerful organizations within the society. In the case of the United States, you would infiltrate the CIA, and through the use of techniques unknown to them, you would take over some of the key people in their inmost core group. You would proceed in the same fashion to take over key members of the KGB. You would also create great dissension among the public at large, some individuals and groups insisting that they have seen UFOs, others insisting with equal vehemence that such a thing is not possible, and that they are either liars or deluded.

You would involve the planet's two major nations in an on-going idiotic philosophical dispute, keeping them constantly at each other's throats over such questions as whether Thomas Jefferson was greater than Karl Marx or vice-versa. You would keep them continuously occupied with quarreling like two adolescent boys trying to prove their masculinity over who has which piece of territory, whether one has the right to invade Afghanistan or the other has the right to invade Nicaragua, persistently exchanging threats and insults like a couple of macho teen-agers, while arguing whether one should dismantle one type of nuclear warhead, or the other should dismantle another type of nuclear warhead. As you watched all this, you would sit back and you would laugh, if you had the capacity to laugh.

(Note by G.A.: The information in this chapter was given to me before the advent of St. Gorby transformed the

Red Menace of the Evil Empire into our long-lost brothers-in-arms and comrades-in-camaraderie, freedom-loving democracy-demanding kindred spirits. In the euphoric thaw that characterizes U.S.-Soviet relations as of the month of December, 1989, these statements are no longer accurate. However, they do remain valid as descriptions of the Cold War mentality, which for so long afflicted both nations that it constitutes a history lesson we should never forget.

Post-Script: No sooner had I inserted this note than George Bush sent an emissary to shake the hand of the Butcher of Tienanmen Square and broke the treaty we had so solemnly signed with the Organisation of American States by arrogantly invading Panama without consulting our allies, thereby escalating international tension back to the previous intolerable levels, single-handedly reviving the Cold War nightmare in order to avoid cutting one single dime from the so-called "Defense" budget.)

You would make yourselves known to various elite in-groups, who would offer you protection out of greed, expecting to acquire more perfect knowledge than anyone else on the planet of this ultimate secret to end all secrets. They would covet you, and you would trust their covetousness and their crass stupidity to trap them. You would do it on both sides of the Iron Curtain.

You would occasionally let your ships be seen by some of the ordinary citizens, so that the elite governmental groups would become involved in attempts to keep them quiet,

clumsily squelching attempts to make information about UFO activity public. This would result in the mass population losing confidence in the veracity of their elected officials. There would be constant arguments between the authorities and the public as to whether or not the persistently reported phenomena genuinely existed, thereby setting the population and the government at each other's throats. You would have already set the two major super-powers at each other's throats. By subtly causing economic turmoil, you would set the "Haves" and the "Have Nots" at each other's throats. In all possible ways, you would plant the seeds of massive discontent.

After you had manipulated the population to the point where your covert control over it was complete, you might decide to go overt, and let a few ships land in public. But you would not go from covert to overt until you were sure of the totality of your control.

You would start doing cross-breeds, escalating the process to the maximum from generation to generation. As the process continued, you would begin to have more and more creatures walking around who were obviously hybrids between the Grays and humans. Perhaps in a century or two, some of the Grays would begin to physically intermingle with Earthlings. But for the time being, anything that walks around will at least look as if it is human. This arrangement is simpler, because it keeps mass panic to a minimum.

The Grays would not be at all reluctant to change their appearance. In comparison with most of the other space races, they are considered rather repulsive. They are interbreeding with humans on an ever-increasing scale, and there are going to be a lot more three-month interrupted pregnancies.

Those who have experienced UFO sightings or ET close encounters will constantly be at odds with the government, which will continue to retaliate by stigmatizing them as liars or deluded. The U.S. and the U.S.S.R. will continue to play their adolescent prestige games with nuclear weaponry. The impoverished will become even more impoverished, and more filled to overflowing with explosively righteous anger. The wealthy will cling even more greedily to the wealth that they already have, creating a social atmosphere of sheer desperation and complete confusion. To add to that, there will be series after series of "natural" disasters, some genuinely natural, some human-induced through aberrant scientific activities such as underground nuclear testing, others deliberately induced by the Grays through the technology they are in possession of. When approximately three-quarters of the planet's population has been eliminated in this fashion, the Grays can then make an overt appearance as saviors from the skies, distributing food and medicine to the survivors. As the survivors line up to receive their quotas of food and medicine, implants will be inserted, supposedly to aid in further food

distribution, actually to guarantee complete Gray control with no possibility of rebellion. From the point of view of the Grays, terrestrial humanity will have been reduced to manageable numbers and to eternal submission.

Humanity is not about to be invaded. Humanity is not in the middle of an invasion. Humanity has been invaded! The invasion has taken place, and is nearly in its final stages. Great invasions do not happen with thundering smoke and nuclear weaponry. That is the mark of an immature society. Great invasions happen in secrecy.

You throw a crumb out here and there. You bribe the U.S. government with a few tidbits -- a Stealth bomber, a Star Wars system. You encourage the government to think that the UFO researchers indeed threaten the security of this great secret they have. You tempt and tease the Soviet Union with a laser system far finer than any their own scientists could think of. And you always keep that subtle inference just on the borderline of consciousness that the elusive will-of-the-wisps termed UFOs may in fact exist, yet you persistently repress this borderline perception, and make it seem so insane that there is a social stigma attached to declaring one's conviction that the phenomena are in fact real.

While all this confusion is going on, the Grays are gradually changing you over. The inner core of the CIA is deeply controlled by the Grays. The CIA see the Grays as a path to greater scientific achievement, as a way of

overpowering the Soviet enemy. Surprisingly enough, the obtuse collective mentality type that makes up the bulk of the CIA also makes up the bulk of the more fanatic Star People, those who babble and mush and gush so endlessly. All those who have to cleave to or be fused with some sort of group mentality leave themselves wide open. They have already been taken over. There is a large and ever-growing cult of contactees who think of the Grays as liberators, sincerely believing them to be heavenly Star Brothers who have come to help humanity.

The reason the awful little Grays mutilate animals is the stuff that they eat. They eat pulverized hormonal secretions, what you would call subtle essences. They live on the stuff of life. There is something deathlike about their species. They always bring about the death of animation, the death of individuality.

How do I know? I am a Blond of Procyon. We were a culture that could travel through time, but also lived on a planetary sphere. And the little Grays, our insidious little friends, did to us exactly what they are doing now to you. This is what happened to our planet.

Having come in war, but having been unable to obtain any decisive victory, the Grays expressed the desire to make peace. We had not wanted to fight with the survivors of the Rigelian Great War to begin with, and gladly accepted their offer. As time went by, they said they wished to normalize relations and be our friends. We were in doubt as to

whether it would be safe to trust them, and debated the issue for a long time before finally deciding that we should trust them, as they were the only other surviving remnant of our original ancestral stock, though horribly deformed by the misfortunes they had endured.

The Grays began to visit us, first a few as ambassadors, then as specialists in various domains where their expertise could be useful to us, as participants in different programs that developed which involved mutual collaboration, and finally as tourists. What had begun as a trickle became a flood, as they came in ever-increasing numbers, slowly but surely infiltrating our society at all levels, penetrating even the most secret of our elite power groups. The one secret that remained beyond their grasp, because the part of their intelligence that was capable of understanding its subtle complexities had atrophied during the nuclear winter that had caused the mutation of their species, was our ability to transcend time and travel through time.

How then did we fail to foresee our own future, and the fatal mistake we were making when we first let them in? Just as on your planet they began by unobtrusively gaining control over key members of the CIA and KGB through techniques unknown to them, such as telepathic hypnosis that manipulates the reptilian levels of the brain, so on Procyon through the same techniques, whose existence we were not aware of either, from the start they established a kind of

telepathic hypnotic control over our leaders. Over our leaders and over almost all of us, because it was as if we were under a spell that was leading us to our doom, as if we were being programmed by a type of ritual black magic that we did not realize existed.

Just as a few of the original tall Blondes clandestinely left Rigel when the Great War was about to break out, so did a few of the original tall Blondes clandestinely leave Procyon and escape into the corridors of time just before the Grays completed the slow undermining that culminated in their sudden take-over of Procyon. Those who stayed behind came under the total domination of the Grays.

The Blondes you see on the same ships as the Grays, working with them, are hybrids, or they are clones. One way to distinguish the clones is that they look alike. The real Blondes have distinct facial feature differences, and do not look alike.

The clones have thick necks and coarsely muscular bodies. They do not have the ability to teleport or to travel interdimensionally. They can be contacted by telepathy, but are unable to send. They can be given orders telepathically. They are zombie-like flesh robots. You can tell that they are of low intelligence by looking into their eyes.

The real Blondes are also muscular, but have slender necks and agile bodies. Their eyes are alert and of high intelligence. Physically they are almost identical to

humans, the main difference being that by human standards their blood circulatory system is under-developed, while their lymphatic system is over-developed. This gives them stronger immune systems than terrestrial humans.

The hybrids are in an intermediate state between the real Blonds and the clones.

After what has happened to Procyon, no true Blond would collaborate voluntarily with the Grays. The Grays have taken some prisoners of war, who have no choice in the matter, and are forced to work with them in order to survive, with the hope of escaping. There are also a few Blonds who have become degenerate renegades, space pirates and mercenaries who sell their services to the highest bidder. But many of us remain free, and continue the fight to the finish with the life-form that has become our hereditary enemy. We choose to remain in exile in the corridors of time, where they can not reach us, rather than to live under the domination of the insidious Grays. It is dangerous for us to venture forth from the corridors of time, but occasionally we do so for a hit-and-run strike, similar in nature to a cosmic version of terrestrial guerilla warfare.

We must periodically enter a substantial physical form for a period of repose, or to breed progeny, in order to continue to survive, but otherwise we constantly travel the vast corridors of time. That is why we may appear to fade in and out like holographic images to human perception.

What I have come here to communicate, if only to one or two people or a small group, is that what is now in the process of happening to your culture, also happened to ours. It is the same fate our own culture suffered. And the Blonds you see with the Grays are either hybrids, clones, or prisoners of war. Because no true Blond who got out untouched, unscathed, uncrossed with those Grays would ever be with them. He or she would prefer to be in a state of non-existence.

Besides the Blonds and the Grays, ships from many other space cultures are watching planet Earth at this time with extreme interest. Scientists from other space cultures are studying what is going on here during this decisive period of your history. If your elected representatives had not so stupidly made a deal with the only aliens willing to provide them with weapons systems, with the short-sighted goal of overpowering the Russians, the Grays would not have achieved their present dominance, and you would now be exchanging ambassadors with a wide variety of space cultures.

What I want to get across to you is that the ultimate evil, which underlies all the negativity in the cosmos, finds expression in that masked form of psychological complacency which leads an individual to adhere to a group philosophy rather than to think things through for oneself. Those who feel safe and comfortable in no matter what belief system merely because many others adhere to it, who get together and form an arrogant self-righteous group convinced

it has a monopoly on the truth, and who are ready to persecute, kill or stifle anyone who challenges that group's philosophy, have formed an alliance with the ultimate evil, whether they know it or not. It is the self-righteousness and implacability of certain elite power groups like the CIA and the KGB, certain organized religions, and certain so-called lunatic fringe groups such as some of the more fanatical Star People, which are so objectionable. It is as if the self-righteous elite power groups and the self-righteous lunatic fringe groups were mirror opposites of each other, and thus equivalent to each other. The elite groups see the fringe groups as their enemies, and vice versa, but they each think of themselves as a "chosen" special group. As soon as you become involved in a belief system that you are a "chosen" special group, who are as lords over the common folk because of your secret knowledge, you are on your way to a fall. That type of attitude plants the seed of destruction in any society or culture, leaving it vulnerable to overthrow by those oppressed within its boundaries, as well as by outside forces. All cultures who have elite groups at odds with each other, and with the population at large, sooner or later collapse from either internal or external pressures.

A healthy organism does not encapsulate portions of itself off that cease to interchange freely with other portions of its body. This type of condition is a prelude to cancer, whether it occurs in an individual or in a

society. The only chance of retaining your freedom is for the awareness of this principle to penetrate the consciousness of humanity. It is a pearl of wisdom treasured by those who have attained the ability to travel through time and other life cycles.

I have seen civilizations rise and fall, begin again only to die again, over and over and over. It isn't only a problem of this planet. It's a problem that must be faced by all civilizations in the course of their development, no matter where they may be located in the cosmos. Everyone wants that slightly larger piece of the pie than their neighbor for themselves, and eventually this tendency always culminates in choking them. Sooner or later this will be the undoing of the Grays as well, thereby enabling us to return in triumph from our exile in the corridors of time. The Grays do not see and are incapable of understanding their own fundamental error: that the very weakness they seize upon in humanity is their own inherent weakness, the blind spot that inevitably seals their doom.

Minerals evolve into plants, plants into animals, animals into humans, and humans into angelic energy-forms. But to try to force a rock, when it is in the state of being a rock, to perform like a plant is utterly futile. To try and change the arrogant mentality of a self-righteous government official or of a fanatical Star Person is as futile as trying to make a rock perform like a plant, unless

At this stage, one thing you can do is to provide the public with as much information as possible. This will make it more difficult for the collaborators and Grays in disguise within the government to continue to work against humanity in favor of the Grays. Tell the public how to put their minds into a state that the Grays cannot penetrate, by focusing the mind on powerful imagery, different for each individual. The only way to victory is through the strength of your consciousness. When genetic or other manipulations are being performed on the abductees, the Grays expect them to cringe in fear, and derive a second-hand high from the intensity of the emotions expressed. If instead of cringing in fear, an abductee can put his or her mind elsewhere, focusing attention on dynamic protective imagery of a religious or mystical nature, it decreases the gratification that the Grays are getting from their second-hand high, and it confuses them. Center the consciousness on something so different from what they expect that it puzzles them. No matter what the physical situation may be, it is essential to send this S.O.S. telepathic message to the higher powers protective of humanity without becoming entangled in negative emotions such as fear, rage or hatred. Negative emotions not only diminish the effectiveness of one's S.O.S. message to the higher powers in the universe, they are the type of response that the Grays are used to evoking and are expert at manipulating. If you combat the Grays with hatred in your heart, you become like them, and further entangled

with them, instead of free from them, A difficulty with the viewpoint of many of the adherents of organized religions is that they tend to perceive the Grays as demons, and therefore to hate them. Although to some extent this analogy is valid, hatred is a form of attachment, a negative emotion they know well how to use to bind you to them. A more correct perception is that the Grays are a species that is terminally ill, having exhausted their DNA, and are therefore in a state of desperation. That is why they are so ruthless in their genetic and other experimentation. Their physical bodies are degenerating from generation to generation. The Grays do not have progeria, but their DNA is running out, and no longer replicates properly, so they are unable to replenish themselves. It is not progeria, but it is similar to progeria, almost like a progeria of the entire species.

It should be remembered that aggressive behavior or attempts at physical resistance during an abduction may result in death. The Grays have no more compunction about taking human life than humans have about taking reptilian life. During the time that one is in their power, one has no more control over what happens physically than does the victim of a human kidnaper or rapist. Their "chosen ones" are attempting to sugar-coat the bitter pill and get you all to stand in line to be processed without any effective resistance, like cattle into hamburger, depicting abduction by the Grays as a glorious experience that everyone should

have. These "chosen ones" are the "bellwethers" that Charles Fort referred to.

There are other E.T. groups you would be happy to work with and travel in the vehicles of, but the track record that the Grays have left behind them leaves no room for doubt as to their malignancy. The only reason the Grays have such a degree of dominance over you is because your elected officials stupidly made clandestine agreements with them, binding you to them in an exclusive alliance that is respected by other space races, allowing them to install themselves in underground bases impregnable to your weaponry, a situation you must now find a way to extricate yourselves from.

In antiquity this planet was divided into sectors between four different groups: Blonds, Grays, large lizard-like beings from the Capella system, and beings from the Arcturus system. These groups still consider themselves to be the owners of this planet. They do not recognize the human claim to ownership. However, some of us do recognize human rights, as well as the rights of other life-forms. There is at present an alliance between the tall Blonds and the large lizard-like beings from the Capella system to drive out the Grays. The beings from the Arcturus system are at present neutral observers, not participating in the conflict. The Blonds and Capellans have deep moral repugnance for the activities of the Grays on this planet at this time, and are willing to help humanity, if humanity

will take effective steps to stop its pollution of the planetary environment. The Grays have become a criminal species, and will be treated as such. However, any species that pollutes its own environment to the point of endangering the survival of its planetary biosphere is also guilty of a cosmic crime.

The space shuttle "Challenger" was destroyed because one of its scheduled operations was an experimental attempt to dispose of nuclear waste by projecting it into outer space. Vehicles of other cultures could collide with canisters of nuclear waste projected into outer space. Canisters could also be broken open by meteor showers, and contaminate whole zones of the universe. It was not an intelligent idea to try and shoot a canister out from the space shuttle. It is not enough to launch canisters beyond the periphery of your solar system. There must be a preplanned crash on a specific target. The only safe way is to select a system that is about to super-nova, and then send an unmanned space-ship loaded with nuclear waste on a collision course directly into that solar system's central sun. The second-best solution would be to send a ship on a collision course into the sun of a solar system where conditions are incompatible with the existence of life-forms. To send it into your own sun could cause a solar flare that would reduce all forms of life on Earth to dust and ashes. The nuclear waste produced on Earth must be kept on Earth until a safe way to project it to a suitable target

area is found. Jupiter is the closest target to Earth that is acceptable for this purpose.

Enochian is the lingua franca of the space races, much as Swahili was the lingua franca of the many African languages. Enochian is the correct time-tested traditional way for Earthlings to communicate with extra-terrestrials. In the Golden Dawn Enochian system, the Great King of Air is the appropriate intermediary to be called upon as a benign go-between in negotiations between Earthlings and extra-terrestrials. Enochian was the ancestral root-language of the original Blonds on Rigel before the Great War.

Although active resistance to the Grays would not be advisable at the present time, due to their technological advantage, this does not mean that you should surrender. It means that you should focus your attention on the different techniques of passive resistance that may be applicable to the situation, making the fullest possible use of your individuality, which so puzzles and confuses their collective hive mentality. As collective thought patterns enhance the ability of the Grays to manipulate you, original thinkers acting on their own are more likely to have success than mass movements led by leaders who do everyone else's thinking for them.

In preventing the take-over of your planet as a colony ruled by Gray overlords, you should go back through your own history and learn what you can from the techniques of passive resistance used to bring about the independence of

India, used by the American Indians and Blacks during their oppression in the United States, by the Blacks in South Africa at the present time, by the French Resistance during the Nazi occupation, and anywhere else in your historical records where there are lessons of this nature to be learned. The point of passive resistance is to endure, to survive until the moment when it becomes possible to switch over to active resistance because outside help has come -- being careful to avoid the mistake of the citizens of Budapest, who rose up believing propaganda assurances that the United States would support their uprising, only to be crushed by Soviet tanks when no such help was forthcoming. Prematurely triggered active resistance would be a disaster that would enable the Grays to perpetuate their colonization of this planet, exactly the type of situation they would try to bring about. Beware of zealots with an obsessive hatred of the Grays, who may have been subconsciously programmed by the Grays to act as agents provocateurs. If you get all those sincerely devoted to resistance together into one place, it is much easier to wipe them out. If the resistance remains disseminated among the population at large, it is more difficult to round them up. Don't add to the superiority of the Gray position by playing into their hands. And remember that although their technology is far in advance of yours, you do vastly out-number them, and can over-extend them. They are already over-extended elsewhere, and unable to commit further forces to this area of the

universe, so those already here must operate without reinforcements coming to them.

You are so far outstripped in terms of physical weaponry that you must find a source of strength that transcends the physical -- such as techniques of centering consciousness on powerfully motivating imagery, which would be different from one individual to another. For the religiously oriented it might be a key event in the life of Jesus, Buddha, Mohammed, Moses, or whoever the appropriate figure would be in the tradition one's belief system is centered around. For those who are not religiously oriented, it would be whatever figure that person sincerely admires as representing what is best in humanity, whether it be an artist or inventor or other type of benevolent leader of society. If the admiration is not wholeheartedly sincere, the intensity with which the attention is focused on the symbolic image in which one wishes to take refuge is not sufficient to be of much use as protection, nor can the attention be maintained for long. The degree of protection given by such imagery depends largely on the intensity and endurance of the single-pointed attention. So it is best to choose whatever figure you genuinely feel spontaneous admiration for, whatever image makes your heart sing and makes you feel at one with the infinite. That will always work, and is all we can do for now.

An example of the type of attitude that the Grays find most confusing is the classic Buddhist discipline of

meditating on a bloated corpse until one roars with laughter upon realizing what a complete cosmic joke existence is. The most likely way to extricate oneself and others from a potentially disastrous situation is to keep the consciousness centered and the heart still, realizing the situation to be the illusion that it is. Do not act out of fear, thereby insuring the victory of the opponent. If one allows oneself to be intimidated, the inevitable result is death. In no matter what type of situation, retain your sense of humor and perspective. Learn to apply the T'ai Ch'i disciplines in non-physical fashion. Center yourself, then act from that center.

Since the Grays have mastered much deeper techniques of hypnosis than humans have, their take-over of human consciousness can only be prevented by strong imagery of a religious or mystical nature. Your contemporary hypnosis works within the mammalian portions of your brain, which in terms of evolutionary development are the more recently acquired portions. Being partially reptilian themselves, the Grays know how to manipulate the reptilian level of your brain, which is the most basic and ancient level. The only way to counter-act such manipulation is by activating the most high of the highest levels of consciousness accessible to you at your present stage of development. If one is unable to maintain an image evoking that highest level of consciousness firmly in one's thoughts, their hypnosis can bypass the higher levels of your evolutionary development

and take control of the deep reptilian level, in this fashion overpowering an individual's true will and obliterating the integrity of the soul. That is how they took over key officials of the CIA KGB, and other powerful elite groups within your social structure. They only need to control the elite at the tip of the top of the social pyramid, the top hundredth of one percent of the population, in order to control us all. A person enslaved in this fashion can be made to do things that your type of hypnosis could not make them do, such as murdering their closest friends or family members.

Having gained control over the reptilian level of consciousness, they temporarily paralyze all portions of the mammalian brain higher than the ape level, then activate the ape level's more violent responses, such as territorialism, greed, lust or rage. Humans can be made to respond like apes, unless they are able to resist the attempt to take them over by activating the level of consciousness that corresponds to the crown chakra. Any attempt to fight back at the ape level insures the success of the Grays. The ape-level belligerence, territorialism, and posturing for purposes of prestige and dominance, which are unfortunately so characteristic of the U.S.-U.S.S.R. relationship on both sides, deliver the population of this planet bound hand and foot into the power of the Grays.

After having destroyed approximately three-quarters of the present population through the introduction of viral

diseases and the induction of assorted catastrophes, the Grays would not even need to make an overt appearance as saviors from the skies. They could replace humans with hybrids unobtrusively. It could be done so gradually that no one would realize what was happening. The transition from humans to hybrids could be so subtle and seamless that the change-over would never be noticed. It would not even be mentioned in the history books, as scientists would assume that the physical and mental changes were the result of naturally occurring evolution. Human history would become hybrid history without anyone understanding what had actually occurred. The governments might even continue to deny the existence of UFOs.

All that would be needed would be to continue the process that is already in operation. Some researchers are aware of the fact that the hybrids which turn out to resemble the Grays are removed from their mothers and taken elsewhere, but very few are aware that the hybrids which turn out to resemble humans are left to grow up in human society.

Before taking hybrids back to their home base to give a much-needed genetic boost to their own ancestral stock, they would want to carry out intensive long-range studies. Certain questions would need to be answered, such as: are the hybrids psychologically stable? Disease-resistant? Productive? Aggressive? They would want to observe the interplay between humans and hybrids, in order to make sure

that the hybrids had the qualities necessary to become leaders in human society. In general, Gray/human hybrids would require less food and sleep than terrestrial humans. They would tend to be more intelligent and slender, but emotionally cold. This does not mean that any human with these characteristics is necessarily a hybrid. As many as 3% of the present population may already be hybrids. All the Grays would have to do would be to continue doing exactly what they are doing, to keep boosting that percentage bit by bit, with an occasional sudden jump in the wake of seemingly natural catastrophes, until the original human population has been 100% replaced by hybrids.

Why do I know so well how such an operation is carried out? The process is quite similar to that by which the Blonds replaced Neanderthal man with Cro-Magnon man. However, the intelligence of terrestrial humanity has now evolved to the point where it has a choice in the matter. By understanding the long-term hive-mind strategy of the Grays, individual humans who attain multi-dimensional awareness can circumvent and short-circuit it. If enough individual humans do this, and refrain from quarreling over whether the state of multi-dimensional awareness is to be called Christ-consciousness or any of the other names it has in the different traditions, uniting together from all traditions to liberate the planet, the Grays will be obliged to seek elsewhere in the cosmos for a slave species they can genetically manipulate.

At some point help may come from outside, from my own and/or some of the other space races. There may also be revolt within the ranks of the Grays, based on widespread discontent with their rigid insectile hierarchical caste system. In the process of infiltrating a species, the Grays can not avoid being influenced by that species, and some of them who had never thought of questioning authority are beginning to do so, due to the influence of human contact. The Grays are having problems not only within their own ranks, but also on other planets they have colonized. As a species they are afflicted with severe, perhaps terminal, health problems. They have substantial captive populations of Blond, human and other prisoners of war, eager to join a revolt at the slightest opportunity.

There is no reason why one should not send out telepathic appeals for help, in the form of prayer or meditation, or in whatever way is appropriate to the individual, to the higher forces in the cosmos. They do exist, and are sensitive to such signals. There are extra-terrestrial and other-dimensional cultures capable of harnessing the innate power of entire galaxies, who could be of immeasurable help in liberating your planet from domination by the Grays, if you could persuade them to intervene. However, they are unlikely to respond until humanity cleans up its own act and stops polluting the planetary environment. One can also send out telepathic signals of encouragement to those among the Grays who have

begun to question authority and acquire a taste for human freedom, but it would be suicidal to attempt to fight the Grays directly with the weapons at present at your disposal.

One must be rational in attempting to fight back, and understand the proper way to proceed. Your own consciousness is the most potent weapon that is available to you at the present time. The most effective way to fight the Grays is to change the level of your consciousness from linear thinking to multi-dimensional awareness. Your secret weapon, your ace in the hole, is that you are not hive-mind collective thinkers, though many of you do fall into that category by conforming to conventional group-patterns, and are therefore easily controlled by the Grays. Collective thought-patterns among humans empower the Grays. It is your individuality which is your best weapon, because it is the one weapon you have that the Grays do not have. The major weakness of the Grays, their area of vulnerability, their Achilles heel, is their inability to think as individuals. They are an extremely telepathic high-tech society, but as individuals they are not creative thinkers. They take orders well, but they do not conceptualize well. They have the technology to throw your planet out of orbit, but there is one key ability that you have and they do not have: the ability to hold in mind imagery that inspires an individual to realize his or her direct personal connection to the source of all that is, which is the ineffable Godhead, no matter what name you may call it. That is your key to victory."

G R U D G E 1 3 R E P O R T

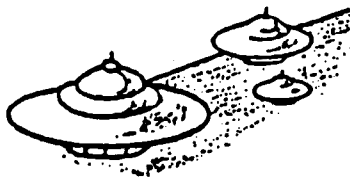

A series of PROJECT GRUDGE/BLUE BOOK reports have been released over the years in connection with the USAF's investigation into UFO's which was supposedly terminated with the release of the Condon report in the late 1960's. Reports 1 through twelve of GRUDGE/BLUE BOOK were generally innocuous and contained no classified or truly sensitive material. There was a final report, #14 which was widely circulated and about which an entire book was written: **FLYING SAUCERS: AN ANALYSIS OF THE AIR FORCE PROJECT BLUE BOOK SPECIAL REPORT NO. 14** by Leon Davidson; the fifth edition was published in 1976 by Blue-Book Publishers; 64 Prospect St., White Plains, New York 10606. Missing from public view, however, was report #13.

Several years ago, Bill English, son of an Arizona state legislator and former captain in the Green Berets had been assigned to an RAF 'listening post' north of London as an information analyst. English was, in the course of his duties, asked to prepare an analysis of the elusive GRUDGE 13 report. On his discharge from his work at the 'listening post' he returned to the United States and began to do a little UFO research on his own. English had been no stranger to the UFO phenomenon. In Viet Nam he was a member of a Special Forces investigative team that went in to retrieve a B-52 that was forced down by a UFO and all the occupants killed. Communications had been received from the B-52 before it went down to the effect that it was "...under attack by a UFO..", a "...large light...". The plane was found intact, sitting in the jungle. There was no swath indicative of a crash landing. Only the bottom of the fuselage showed any damage, there was no damage to the underside of the engine pods. Although the plane was completely intact the entire crew had been mutilated.

English, through contacts he still maintains has determined that the US government 'most definitely' supports a 'project dealing specifically with UFO's and captured aliens'. According to what he has learned, the US government captured a trio of aliens, and that as of mid 1981, one of the beings was still alive in captivity. English also claims that "at one point in the early 1950's until the mid 1960's the Air Force maintained relocation and debriefing colonies for people who had experienced close encounters of the 3rd and 4th kind. They were isolated for all intents and purposes for the rest of their lives. He doubts that these colonies are still in existence.

English dictated 2 audio cassettes outlining what he remembered from the Grudge 13 report. These audio cassettes were transcribed into hand written notes by another person. The information contained therein indicated what had been suspected all along: that the U.S. Government was involved in the greatest deception in the history of mankind and that not only did flying saucers exist but that the government had several in secret storage and had captured at least 3 live aliens.

The following is a summary of what Bill English remembers from what he read during that day in June, 1977 of PROJECT GRUDGE/BLUE BOOK REPORT NO. 13.

In Box, diplomatic pouch under lock and key system. Lock had been opened, pouch was easily accessed. Standard diplomatic couriers pouch marked American Embassy Couriers, contained pouch serial number JL327Delta. Inside a publication with red tape which indicated code red security precautions and an Air Force disposition form. Disposition form was standard white page copy, title was 'Analysis Report'. Further down was 'Analyse enclosed report under code red measures, give abstract breakdown and report on validity. Observe all code red measures. Analysis required immediately'. Underneath were a series of dashes then the letters NDF then another series of dashes. Below that, lower left hand corner were the initials WGB.

Publication was withdrawn from pouch. It measured approximately 8" by 11" with gray cover. Heavily bound, paper back style similar to technical manuals. Across the center front it read, "Grudge/Blue Book Report No. 13". It was dated 1953-(1963). In the lower right hand corner was AFSN 2246-3. In upper left hand corner was the word 'annotated'. Across the front upper right hand corner to lower left hand corner was red tape indicating code red security measures. Across the front was stamped in red ink 'Top Secret Need To Know Only Crypto Clearance 14 Required'. Inside front cover upper left hand corner were hand written notations in ink which were blacked out by black felt pen.

Inside cover sheet was basically the same information as the cover. Second page was title page. Next page after that was an appendix with numerous notations made in it. Notations dealt with inserts of what appeared to be photos and additional notes. At bottom of third page it read G/BV Page 1 of 624 pages. Title page was subject letter. Complete list of appendix not remembered. Title. Some notes on the practical applications of the Worst Nemo equations.

Table of Contents, Part 1. "On the design of generators to accomplish strain free molecular translation". Part 2, "the generation of space time discontinuums, closed, open and folded". Part 3, "on the generation of temporary psuedo acceleration locas". Part 1, Chapter 1, "design criteria for a simple generator and control system referring to equation 17 appendix A". Part 2 chapter 1, "Continuation of Einsteins Theory of Relativity to final conclusion". Part 3, chapter 1, "Possible applications of Ein^steinian theory of relativity at conclusion".

Part 1, chapter 2, reports of UFO encounters, classification "Close Encounters of the 1st Kind", subtitle sightings and witnesses. Part 2, chapter 2, "Close Encounters of the 2nd Kind", subtitle UFO sightings witnessed within close proximity. Part 3, chapter 2 "Close Encounters of the 3rd Kind", subtitle UFO encounters and extraterrestrial life forms witnessed and personal encounters. Subtitle, "colonies relocation thereof". Case histories. Chapter 3 Part 1, titled "Military Encounters with UFO's". Part 2 Chapter 3, "Military Reports Concerning Sightings on Radar and Electronic Surveillance of UFO's". Subsection 2, Analysis

Report, J. Allen Hynek, Lt. Col. Friend. Appendix continued on for about 5 pages. Opening subject page consisted of a report of the findings as written by Lt. Col. Friend and his analysis.

Must stress at this point that the version seen was annotated. There were inserts that were added to this copy after it had been initially printed. Sections remembered very vividly are the photographs and the reports concerning captive sightings of various UFO's to include Mexico, Sweden, United States and Canada. There were also what was then classified Close Encounters of the 3rd Kind. It was made very clear that these people whom it was determined had genuine CE 3's were moved in the middle of the night by Air Force personnel and relocated to various sites in the midwest and northwest parts of the United States. In many cases these people experienced physical ailments from exposure to various types of radiation.

One case especially noted and remembered very vividly was entitled 'Darlington Farm Case' out of Ohio. Case apparently took place in October 1953. Man, wife and 13 year old son were sitting down at dinner table. As they sat there the lights in the farm house began to dim. Dogs and animals raised ruckus outside. 13 year old boy got up from dinner table to see what was going on. Called his mother and father to come look at the funny light in the sky. Father and mother got up and as they got up the son went outside into the yard. Father and mother went out onto the porch. When they got out on the porch one of the dogs broke loose from leash beside house and came running around front. Boy began chasing it out into the open field. As mother and father watched the light came down from the sky. They described it as a round ball of fire and it began to hover over field where boy and dog had run to. As they stood and watched, the mother and father heard the boy start screaming for help whereupon the father grabbed his shotgun which was right next to the door and began to run out into the field with the mother following. When the father got to the field he saw his son being carried away by what looked like little men, into this huge fiery looking object. As it took off the father fired several rounds at the object, to no avail. They found dog, its head was crushed but no sign of boy or any other footprints of the little men who apparently carried him off. Father immediately called Darlington police and they immediately came out to investigate. The official report read that the boy had run off and was lost in the forest which bordered the farm. Within 48 hours the Air Force made the determination that the family was to be relocated and the mother and father were picked up by Air Force Intelligence and all personal belongings and possessions were loaded into U.S. Air Force trucks and moved to a northwestern relocation site.

The mother was in shock and had to go through a great deal of psychotherapy and deprogramming as did father. One interesting aspect about this case was classification under the Air Force report which read it was a genuine CE 3 and that for the good of the national security the mother and father had been relocated to re-

location zones Z21-14. Not sure whether this indicated map grid coordinates or latitude longitude. According to the report there were at least 4 relocation sites across the United States. Depending upon which type of encounter these people had, the report indicated that there were extensive medical facilities available at these relocation sites to deal with all medical emergencies up to and including radiation poisoning. The report mentioned a site located in the Utah-Nevada area, but no indication of its purpose or what it was for.

Report gave clear indication of reports of human mutilations, most notably was a case witnessed by Air Force personnel in which an Air Force Sgt. EE-6 by the name of Jonathon P. Lovette was observed being taken captive aboard what appeared to be a UFO at the White Sands Missile Test Range in New Mexico. This abduction took place in March of 1956 at about 0300 local and was witnessed by Major William Cunningham of the United States Air Force Missile Test Command near Holloman Air Force Base.

Major Cunningham and Sgt. Lovette were out in a field downrange from the launch sites looking for debris from a missile test when Sgt. Lovette went over the ridge of a small sand dune and was out of sight for a time. Major Cunningham heard Sgt. Lovette scream in what was described as terror or agony. The major, thinking the Sgt. had been bitten by a snake or something ran over the crest of the dune and saw Sgt. Lovette being dragged into what appeared to him and was described as being a silvery disk like object which hovered in the air approximately 15 to 20 feet. Major Cunningham described what appeared to be a long snake-like object which was wrapped around the sergeants legs and was dragging him to the craft. Major Cunningham admittedly froze as the sergeant was dragged inside the disc and observed the disc going up into the sky very quickly. Major Cunningham got on the jeep radio and reported the incident to Missile Control whereupon Missile Control confirmed a radar sighting. Search parties went out into the field looking for Sgt. Lovette. Major Cunningham's report was taken and he was admitted to the White Sands Base Dispensary for observation.

The search for Sgt. Lovette was continued for 3 days at the end of which his nude body was found approximately 10 miles downrange. The body had been mutilated; the tongue had been removed from lower portion of the jaw. An incision had been made just under the tip of the chin and extended all the way back to the esophagus and larynx. He had been emasculated and his eyes had been removed. Also, his anus had been removed and there were comments in the report on the apparent surgical skill of the removal of these items including the genitalia. The report commented that the anus and genitalia had been removed 'as though a plug' which in the case of the anus extended all the way up to the colon. There was no sign of blood within the system. The initial autopsy report confirmed that the system had been completely drained of blood and that there was no vascular collapse due to death by bleeding. Subcomment was added that this was unusual because anybody who dies or has complete loss of blood there is vascular collapse. Also noted was that when the body was found there were a number of dead predatory

type birds within the area who apparently had died after trying to partake of the sergeant's body. There were a number of extremely grisly black and white photos. From all indications the body had been exposed to the elements for at least a day or two. The New Mexico sun in the desert is extremely hot and debilitating under normal circumstances.

In this section of the report it also indicated that there were numerous occasions in which a UFO tracked alongside of a fired missile and on one occasion said missile was observed being taken aboard a UFO while in flight. The speeds indicated were absolutely phenomenal. (English's father had told him privately that on more than one occasion he had personally tracked what they termed as 'foo fighters'. English's father was an electronic engineer by profession and was fairly well versed on electronics engineering and design and on more than one occasion he was involved in telemetry programming of missiles. English's father is currently a state legislator in Arizona.)

The report also indicated that there were a number of recovery teams that were activated specifically for the purpose of recovering any and all evidence of UFO's and UFO sightings. Most notably recorded in publication was what they called Recovery Team Alpha. It was reported that Alpha had been extremely active in a number of areas and on certain occasions had travelled outside of the continental United States. Alpha was based out of Wright-Patterson Air Force Base and was on the move constantly.

Further information in the report consisted of such things as reported sightings and where air force planes had been destroyed or had combat encounters or had been attacked by UFO's. Also there were autopsy reports of various human mutilations.

About midway through the report came a section which dealt specifically with photographs. Each photo was labeled and appendix to certain reports. A number of photos in there dealt with a recovery program of some type that took place in the southwestern part of the United States. They did not give a location name but they did give grid coordinates for that area. There is no clear indication to exactly where it was. The photos dealt with special teams that were called in to recover a crashed UFO. It also dealt with alien bodies and autopsy reports, autopsy type photographs, high quality, color, 8 x 10, 5 x 7.

Photo number 1 showed an alien being on an autopsy table which is a metal table with runnels and traps underneath to trap fluid and feces. Body appeared to be a little short of 4 feet. Table was about 7 foot. No clothing on body, no genitalia, body completely heterous, head was rounded cranium, slightly enlarged, eyes almond shaped, slits where nose would be, extremely small mouth, receding chin line, holes where ears would be. Photo was taken at angle, side view, looking at body from 45° elevation, left hand was visible, head was facing to left, body was right to left position (head on right, feet on left), eyes were closed appeared oriental-looking and almond shaped, left hand slight longer than

normal, wrist coming down just about 2 to 3 inches above the knees. Wrists appeared to be articulated in a fashion that allowed a double joint with 3 digit fingers. Wrist was very slender. There was no thumb. A palm was almost non-existent. The three fingers were direct extension from the wrist.

Color of the skin was bluish gray, dark bluish gray. At base of the body there was a darker color, indicating body was dead for some time. Body fluid or blood had settled to base of body. This indicated that body had been examined before beginning autopsy.

Picture showed beginning stages of autopsy, following standard procedure, body was slit from crotch to just under chin and green viscuous liquid was in evidence. There were internal organs but these could not be identified. Photos thereafter concerned specific areas of internal organs of what appeared as small cluster of a multi-valve heart or at least 2 hearts within the cadaver. No accurate description of autopsy report or what was found within corpse accompanying photos. Indication that there was no stomach or digestive track per se. Later analysis showed that fluid within body was chlorophyl-based liquid which apparently dealt with photosynthesis or similar process. The report theorized that nourishment was taken in through mouth, however since there is no digestive track or anything of this nature, the waste products were excreted through skin.

One section of report did specify that cadavers were extremely odorous, but this could be accounted for by either deterioration or a number of things, but theory was that waste was excreted through pores of skin. They could only theorize in report because there was no xenobiology.

A report by Dr. J. Allen Hynek was recalled vividly which indicated that he had also studied the information provided by this particular case and that he felt that it was indeed a genuine UFO capture and subsequently the alien was part of UFO. Dr. Hynek was non-committal but did however sign the report. Also indicated in report that he did not view bodies personally, but viewed photographs and accompanying reports from autopsies.

Other photos dealt with a number of bodies which were vivisectioned in various ways. At one point, a head was removed from body and photographed and autopsy was performed on head. The cranium was opened and brain matter was photographed and evident. Interesting thing about photo was that there was a ridgebone or dividing partition-type bone running directly through center of skull, from front to back, as though dividing two brains, one from the other. This seemed apparent from the picture. The skin was completely removed from cranial structure and the skull was layed bare as much as possible.

At one point the skull was cut directly in half and photo showed under developed esophagus and nasal cavaties. No clear photo of eye orbs as we know them, just photos of complete vivisection of skull itself.

Numerous photos of flesh of the being starting with cutaneous and subcutaneous microphotographic plates. Appeared to be cellular studies done under microscope and electron microscope type photos. Extreme magnification of tissue samples.

This concluded the Bill English statement which was transcribed from 2 cassette tapes. I obtained this handwritten memorandum in August of 1987 from Paul Bennewitz during my visit with him in Albuquerque. In September of 1988 I received a call from Bill English. I asked for a chance to meet him and discuss the Grudge 13 report. He said that this could be arranged but that the meeting would have to be on his terms for security reasons. He explained that there had been several attempts on his life by persons unknown since he had made the cassette tapes about 6 years ago. We arranged a meeting at a small airport in Virginia on September 16. I was to sit in the lobby with my black flight bag and for identification purposes I told Bill what I would be wearing. I had no telephone number for Bill.

As I walked in the small airport lobby after a 3 hour drive from Richmond I immediately noticed 2 gentlemen who seemed 'out of place' for this locale. Both were wearing pin-striped 3 piece suits, both had on dark glasses. One was a black gentlemen. One was stationed inside the lobby door looking out at the parking lot, one was leaning up against an airline counter. I sat down and after a few minutes was approached by a tall, bearded man in jeans and a heavy jacket. He asked if I wanted to have a drink. We walked outside and he introduced himself as Bill English. We drove in Bill's car into town to a local bar. About 5 minutes after we ordered and had started to talk, the men I had seen at the airport came into the bar and sat down. We left for Bill's house and never saw the men again for the next 2 days.

During the next 2 days I stayed with Bill and his wife and 2 children in a small trailer in the middle of a field at his farm. I asked him endless questions concerning the Grudge 13 document, how he happened to see it, what happened to him after he saw it and literally thousands of questions about the content of the document. My impression of Bill English was that he was totally honest, that he stood behind his statements and recollection of the Grudge 13 papers, that he was a devoted husband and father to his wife's 2 children. That Bill English was ready to come forward and enter into any debate regarding the legitimacy of the document and his recollections thereof. Of Bill's compassion for his father and his father's feelings concerning Bill and the reasons for their occasional disagreements. I have tremendous respect for Bill and what he has tried to do in getting this information out to the public. It has been at tremendous personal risk not to mention the ridicule by sponsored agents such as Bill Moore who has stated that the Grudge 13 papers are a fraud.

What follows is additional information about the Grudge 13 papers that I obtained

from Bill during my visit. In addition to the following Bill painstakingly drew many sketches of the photos of different types of flying saucers, the equipment obtained from them including a sketch of the football sized nuclear generator and sketches of the autopsy photos.

From my notes taken during our 2 day meeting: Bill described a photo taken of 3 live aliens. Very clear photo, aliens standing against white tile wall, looking confused as if they had been shoved, were looking in different directions.

Report said that aliens had contacted a U.S. Intelligence Agency for initial 2 meetings, one at Holloman one at Homestead.

U.S. Air Force relocation personnel (for persons involved in close encounters) were referred to in report as 'Men in Black'.

Major Cunningham was initially accused of murdering Sgt. Jonathon P. Lovette. Charges were later dropped.

Bill English's place of employment in England was RAF Security Services Command, RAF Chicksands.

Entire Grudge 13 report was written as if report was geared toward preparation of defenses.

Report told of ultrasonic weapons found in Germany at the end of WW 2 that could shatter 4" thick armour.

Report told of sensitive military and industrial areas at which personnel experienced missing time.

Report told about missing time experienced with personnel associated with North American X-15 rocket plane project.

Report stated that there were 17 different extraterrestrial species accounted for up to the time of the report.

Extraterrestrials were referred to as A.L.F.'s, Alien Life Forms in the report.

Report referred to one UFO that was recovered and test flown. The UFO blew up as the 2 Air Force pilot aboard attempted to leave the atmosphere. English recalls the date as the mid 50's.

Report refers to flying saucer program as Project 'Red Light' and that a secret installation had been constructed in the middle of the Atomic Energy Commission testing ground in Nevada.

At the time of the report 11 alien cadavers were being kept at Wright-Peterson Air Force Base.

That additional alien cadavers were being stored at 4 to 5 other medical institutions.

That 2 flying saucers of extraterrestrial origin had been tested in the wind tunnel at Langley, Va.

That at the time of the report one disc was being stored at McDill Air Force Base in Florida.

That at the time of the report, 1 damaged disc was at Eglin Air Force Base in Florida.

That at the time of the report there had been 2 UFO incidents at Ft. Riley, Kansas.

That at the time of the report a detachment of the Alpha recovery team was based at Randolph Air Force Base.

The report discussed civilian and military personnel who had been terminated 'to eliminate potentially dangerous elements to the national security'.

That Gen. James Doolittle had been mentioned several times in the report with the notation that "His (Doolittle's) predictions might be correct." There was no indication of what those predictions might have been.

A short segment containing the quotation, "By presidential order, certain aspects of research had been undertaken."

This report about Bill English and the Grudge 13 papers was prepared by John Lear, 1414 Hollywood Blvd. Las Vegas, Nevada 89110, telephone number 702-438-8181, on October 7, 1988.



EINSTEIN THEORY OF RELATIVITY TO FINAL CONCLUSION PART 3 (CHAPTER)
 POSSIBLE APPLICATIONS OF EINSTEINIAN THEORY OF RELATIVITY AT (CONCLUSION)
 PART 1 CHAPTER 2 REPORTS OF UFO ENCOUNTERS CLASSIFICATION CLOSE
 ENCOUNTERS OF THE 1ST KIND SUBTITLE SIGHTINGS + WITNESSES PART 2
 CHAPTER 2 CLOSE ENCOUNTERS OF THE 2ND KIND SUBTITLE UFO...
 SIGHTINGS WITNESSED WITHIN CLOSE PROXIMITY PART 3 CHAPTER 2
 CLOSE ENCOUNTERS OF THE 3RD KIND SUBTITLE UFO ENCOUNTERS +
 EXTRATERRESTRIAL LIFE FORMS WITNESSED + PERSONAL ENCOUNTERS
 SUBTITLE COLONIES RELOCATION THEREOF CASE HISTORIES CHAPTER
 3 PART 1 TITLED MILITARY ENCOUNTERS WITH UFOs PART 2 CHAPTER 3
 MILITARY REPORTS CONCERNING SIGHTING ON RADAR + ELECTRONIC
 SURVEILLANCE OF UFOs SUBSECTION 2 ANALYSIS REPORT 2 ALLEN
 HYNEX LT. COLONEL FRIEND ON PERTINENT DATA SUBSECTION 3
 REFER TO APPENDIX B AT THIS POINT APPENDIX MEMORY BECOMES
 SLIGHTLY BLURRED BUT CONTINUED ON FOR ABOUT 5 PAGES DURING
 SUBJECT PAGE CONSISTED OF A REPORT OF THE FINDINGS AS WRITTEN
 BY LT. COLONEL FRIEND + HIS ANALYSIS MUST STRESS AT THIS POINT
 THAT THE VERSION SEEN WAS ANNOTATED THERE WERE INSERTS THAT
 WERE ADDED TO THIS COPY AFTER IT HAD BEEN INITIALLY PRINTED
 SECTIONS REMEMBERED VERY VIVIDLY ARE THE PHOTOGRAPHS +
 THE REPORT CONCERNING CAPTIVE SIGHTS OF VARIOUS UFOs TO
 INCLUDE MEXICO, SWEDEN, UNITED STATES, CANADA THERE
 WERE ALSO WHAT WAS THEN CALLED CLOSE ENCOUNTERS OF THE 3RD
 KIND IT WAS MADE VERY CLEAR THAT THESE PEOPLE WHOM IT WAS
 DETERMINED HAD GENUINE CE 3's WERE MOVED IN THE MIDDLE
 OF THE NIGHT BY AIR FORCE PERSONNEL AND RELOCATED TO VARIOUS
 SITES IN THE MIDWEST + NORTHWEST PARTS OF THE UNITED STATES
 IN MANY CASES THESE PEOPLE EXPERIENCED PHYSICAL ILLMENTS +
 EXPOSURE TO VARIOUS TYPES OF RADIATION ONE CASE ESPECIALLY
 NOTED + REMEMBERED VERY VIVIDLY WAS ENTITLED DAKOTA FARM
 CASE OUT OF OHIO CASE APPARENTLY TOOK PLACE IN OCTOBER 1953
 MAN, WIFE 13 YEAR OLD SON WERE SITTING DOWN AT DINNER TABLE
 AS THEY SAT THESE LIGHTS IN FARM HOUSE BEGAN TO DIM DOGS +
 ANIMALS RAGED RUCUS ON OUTSIDE 13 YEAR OLD BOY GOT UP FROM
 DINNER TABLE TO SEE WHAT WAS GOING ON CALLED FATHER + MOTHER
 TO COME LOOK AT THE FUNNY LIGHT IN THE SKY FATHER + MOTHER GOT
 UP + AS THEY GOT UP THE SON WENT OUTSIDE INTO THE YARD AND FATHER
 + MOTHER WENT OUT ONTO THE PORCH WHEN THEY GOT OUT ON THE PORCH
 ONE OF THE DOGS BROKE LOOSE FROM LEASH BESIDE HOUSE + CAME
 RUNNING AROUND FRONT + BOY BEGAN CHASING IT OUT INTO THE OPEN...

FIELD AS MOTHER + FATHER WATCHED THE LIGHT CAME DOWN FROM THE SKY + THEY DESCRIBED IT AS A ROUND BALL OF FIRE + IT BEGAN TO HOVER OVER FIELD WHERE BOY + DOG HAD RUN TO AS THEY STOOD + WATCHED THE MOTHER + FATHER HEARD THE BOY START SCREAMING FOR HELP WHERE UPON THE FATHER GRABBED HIS SHOTGUN WHICH WAS RIGHT NEXT TO DOOR + BEGAN TO RUN OUT INTO THE FIELD WITH THE MOTHER FOLLOWING WHEN THE FATHER GOT TO THE FIELD HE SAW HIS SON BEING CARRIED AWAY BY WHAT APPEARED TO BE LITTLE MEN INTO THIS HUGE FIERY-LOOKING OBJECT + IT TOOK OFF FATHER FIRED SEVERAL ROUNDS AT THE OBJECT TO NO AVAIL THEY FOUND DOG ITS HEAD WAS CRUSHED BUT NO SIGN OF BOY OR ANY OTHER FOOTPRINTS OF THE LITTLE MEN WHO APPARENTLY CARRIED HIM OFF FATHER IMMEDIATELY CALLED DARTMOUTH POLICE + THEY IMMEDIATELY CAME OUT TO INVESTIGATE IT THE OFFICIAL REPORT READ THAT THE BOY HAD RUN OFF + WAS LOST IN THE FOREST WHICH BORDERED THE FARM WITHIN 48 HOURS THE AIR FORCE MADE THE DETERMINATION THAT THE FAMILY WAS TO BE RELOCATED + THE MOTHER + FATHER WERE PICKED UP BY AIR FORCE INTELLIGENCE + ALL PERSONAL BELONGINGS + POSSESSIONS WERE LOADED INTO US AIR FORCE TRUCKS + MOVED TO A NORTHWESTERN RELOCATION SIGHT. THE MOTHER WAS IN SHOCK + HAD TO GO THROUGH GREAT DEAL OF PSYCHOTHERAPY + DEPROGRAMMING AS DID FATHER INTERESTING ASPECT ABOUT THIS CASE WAS CLASSIFICATION UNDER THE AIR FORCE REPORT WHICH READ IT WAS A GENUINE CE 3 + THAT FOR THE GOOD OF THE NATIONAL SECURITY THE MOTHER + FATHER HAD BEEN RELOCATED TO RELOCATION ZONES Z 21 DASH 14 NOT SURE WHETHER THIS INDICATED MAP GRID COORDINATES OR LATITUDE LONGITUDE BUT THERE SEEM TO BE LOCATION ZONES INDICATED HERE ACCORDING TO REPORT THERE WERE AT LEAST 4 RELOCATION SIGHTS ACROSS THE UNITED STATES AT THAT TIME DEPENDING UPON WHICH TYPE OF ENCOUNTER TABLE PEOPLE HAD REPORT INDICATED THAT THERE WERE EXTENSIVE MEDICAL FACILITIES AVAILABLE AT THESE RELOCATION SIGHTS TO DEAL WITH ALL MEDICAL EMERGENCIES UP TO & INCLUDING RADIATION POISONING DEALING WITH IT AS LIMITING AS THEY COULD AT THAT TIME WHICH APPARENTLY WAS VERY EXTENSIVE THERE WAS MENTIONED IN THE PUBLICATION OF A SIGHT LOCATED IN THE UTAH-NEVADA AREA BUT NO INDICATION OF ITS PURPOSE OR WHAT IT WAS FOR PUBLICATION GAVE CLEAR INDICATION OF REPORTS OF HUMAN MUTILATION MOST NOTICIBLY WAS A CASE WITNESSED BY AIR FORCE PERSONNEL OF AN AIR FORCE SERGEANT E E 6 BY THE NAME OF JONATHAN P. LOUETTE WHO WAS OBSERVED BEING TAKEN CAPTIVE ABOARD WHAT APPEARED

To Be A UFO AT THE WHITE SANDS MISSILE TEST RANGE IN
 NEW MEXICO & TEXAS THIS TOOK PLACE IN MARCH OF 1956
 AT ABOUT 3 O'CLOCK IN MORNING THE SERGEANT'S CAPTIVITY
 WAS WITNESSED BY A MAJOR WILLIAM CUNNINGHAM OF THE
 UNITED STATES AIR FORCE MISSILE TEST COMMAND, WHITE
 SANDS NEW MEXICO ^{HOLLAMAN AIR FORCE BASE} APPROX. 3 O'CLOCK
 IN MORNING THE MAJOR CUNNINGHAM + SERGEANT LOVETTO
 WERE OUT IN FIELD DOWNRANGE FROM LAUNCH SITES LOOKING
 FOR DEBRIS FROM A MISSILE TEST WHEN SERGEANT LOVETTO
 WENT OVER RIDGE OF A SMALL SAND DUNE + DISAPPEARED
 FOR A TIME MAJOR CUNNINGHAM HEARD SERGEANT LOVETTO
 SCREAM IN WHAT WAS DESCRIBED AS TERROR OR AGONY THE
 MAJOR THINKING THE SERGEANT HAD BEEN BITTEN BY A SNAKE
 OR SOMETHING RAN OVER THE CREST OF THE DUNE + SAW
 SERGEANT LOVETTO BEING DRAGGED INTO WHAT APPEARED
 TO HIM + WAS DESCRIBED AS BEING A SILVERY DISC LIKE
 OBJECT WHICH HOVERED IN THE AIR APPROX. 15 TO 20 FEET
 OFF THE GROUND MAJOR CUNNINGHAM DESCRIBED WHAT
 APPEARED TO BE A LONG SNAKE-LIKE OBJECT WHICH WAS WRAPPED
 AROUND THE SERGEANT'S LEGS + DRAGGING HIM TO THE CRAFT
 MAJOR CUNNINGHAM ADMITTEDLY FREEZE AS SERGEANT WAS
 DRAGGED INSIDE THE DISC + OBSERVED THE DISC LIFTING OFF
 FROM THE SURFACE + GOING UP INTO THE SKY VERY QUICKLY
 MAJOR CUNNINGHAM GOT ON JEEP RADIO + REPORTED THIS
 TO MISSILE CONTROL + MISSILE CONTROL CONFIRMED A RADAR
 SIGHTING AT THIS TIME SEARCH PARTIES WENT OUT INTO THE
 FIELD LOOKING FOR SERGEANT LOVETTO + MAJOR CUNNINGHAM'S
 REPORT WAS TAKEN + HE WAS IMMEDIATELY ADMITTED TO THE
 WHITE SANDS BASE DISPENSARY FOR OBSERVATION THE SEARCH
 CONTINUED FOR 3 DAYS + AT THE END OF 3 DAYS A SEARCH PARTY
 CAME ACROSS SERGEANT LOVETTO'S BODY APPROX 10 MILES
 DOWNRANGE FROM LOCATION WHERE THEY WERE AT THE
 DESCRIPTION READ THAT THE SERGEANT'S BODY WAS NUDE +
 MUTILATED + THAT THE TONGUE HAD BEEN REMOVED FROM
 LOWER PORTION OF THE JAW AN INCISION BEING MADE JUST
 UNDER THE TIP OF THE CHIN + EXTENDING ALL THE WAY BACK
 TO THE ESOPHAGUS + LARYNX HE HAD BEEN EMASCULATED +
 HIS EYES HAD BEEN REMOVED + ALSO HIS ANUS HAD BEEN
 REMOVED THERE WERE COMMENTS OF THE APPARENT
 SURGICAL SKILL OF THE REMOVAL OF THESE ITEMS + THAT THE

GENITALIA WAS REMOVED WITH THOROUGHNESS PROCEEDING
AS THOUGH A PLUG HAD BEEN REMOVED AS WAS
THE ANUS WHICH EXTENDED ALL THE WAY UP TO THE CROSS
BASE ALSO THAT THERE WAS NO SIGN OF BLOOD WITHIN
THE SYSTEM. INITIAL AUTOPSY REPORT CONFIRMED THAT THE
SYSTEM HAD BEEN COMPLETELY DRAINED OF BLOOD & THAT
THERE WAS NO VASCULAR COLLAPSE DUE TO DEATH BY
BLEEDING. SUBCOMMENT WAS ALSO ADDED THAT THIS IS
UNUSUAL & THAT ANYBODY WHO DIES OR HAS COMPLETE LOSS
OF BLOOD THERE WAS VASCULAR COLLAPSE ALSO NOTED WAS THAT
WHEN THE BODY WAS FOUND THAT THERE WERE A NUMBER OF
DEAD PREDATORY-TYPE BIRDS WITHIN THE AREA WHO APPARENTLY
HAD DIED AFTER TRYING TO PARTAKE OF THE SERGEANT'S BODY.
THERE WERE A NUMBER OF PHOTOS EXTREMELY GROSSLY WHICH
WERE BLACK & WHITE BUT FROM ALL INDICATIONS THE BODY HAD
BEEN EXPOSED TO THE ELEMENTS FOR AT LEAST A DAY OR TWO
NEW MEXICO SON IN THE DESERT IS EXTREMELY HOT & DUBITATED
UNDER NORMAL CIRCUMSTANCES IN THIS SECTION OF THE REPORT.
IT ALSO INDICATED THAT THERE WERE NUMEROUS OCCASIONS IN
WHICH A UFO TRACKED ALONG SIDE OF A FIRED MISSILE & ON
ONE OCCASION SAID MISSILE WAS OBSERVED BEING TAKEN AWAY
A UFO WHILE IN FLIGHT THE SPEEDS INDICATED WERE APPARENTLY
PHENOMENAL (WILLIAM'S FATHER HAD TOLD HIM PRIVATELY THAT
ON MORE THAN ONE OCCASION HE PERSONALLY HAD TRACKED
WHAT THEY TERMED AS FOO FIGHTERS AT THE TIME HIS FATHER
A ELECTRONICS ENGINEER BY PROFESSION & A MEMBER OF THE
ARIZONA STATE HOUSE OF REPRESENTATIVES BY CHOICE BUT
AT THIS TIME HE WAS FAIRLY WELL VORSED ON ELECTRONICS
ENGINEERING & DESIGN & ON MORE THAN ONE OCCASION HE WAS
INVOLVED IN TELEMETRY PROGRAMMING OF MISSILES WHAT HE
REFERRED TO AS ON BOARD COMPUTERS. LOS ALAMOS AREA WAS
ALSO AN ATOMIC TEST SIGHT AREA IN THE LATE 40'S FOR
SOME REASON THERE SEEMS TO BE A RASH OF UFO SIGHTINGS
AROUND THESE AREAS WHICH MIGHT GIVE INDICATION TO
VALIDITY OF BEINGS LOOKING IN ON US IN REGARDS TO WHAT
WE ARE UP TO, THAT KIND OF THING) THE REPORT ALSO INDICATED
THAT THERE WERE A NUMBER OF RECOVERY TEAMS THAT WERE
ACTIVATED SPECIFICALLY FOR THE PURPOSE OF RECOVERING ANY
& ALL EVIDENCE OF UFO'S. UFO SIGHTINGS THIS KIND OF THING
MOST NOTABLE RECORDED IN PUBLICATION WAS WHAT THEY

CALLED AS RECOVERY TEAM ALPHA. IT WAS REPORTED IN
 REPORT THAT RECOVERY TEAM ALPHA HAD BEEN EXTREMELY
 ACTIVE IN A NUMBER OF AREAS + ON CERTAIN OCCASIONS HAD
 TRAVELLED OUTSIDE OF THE CONTINENTAL UNITED STATES IN
 MEXICO + CANADA THEY WERE BASED OUT OF WRIGHT-
 PATTERSON AIR FORCE BASE THEY WERE ON THE MOVE
 CONSTANTLY FURTHER INFORMATION IN THE REPORT CON-
 SISTED OF SUCH THINGS AS REPORTED SIGHTINGS + THE
 KIND OF THING WHERE AIR FORCE PLANE HAD BEEN DOWNED
 OR HAD COMBAT ENCOUNTERS OR HAD BEEN ATTACKED BY
 UFO'S ALSO THERE WERE AUTOPSY REPORTS OF VARIOUS HUMAN
 MUTILATIONS + THIS TYPE OF THING IN THE MIND TYPE UP
 A NUMBER OF THINGS WERE OUT OF SEQUENCE BUT IT DID
 DEAL SPECIFICALLY WITH AREAS AS DIVIDED INTO SECTIONS
 ABOUT MIDWAY THROUGH THE REPORT THERE CAME A SECTION
 WHICH DEALT SPECIFICALLY WITH PHOTOGRAPHS + EACH PHOTO
 WAS LABELLED + APPENDED TO CERTAIN REPORTS ALONG
 WITH PHOTOS IN THERE DEALT WITH A RECOVERY PROGRAM OF
 SOME TYPE THAT TOOK PLACE IN THE SOUTHWESTERN PART
 OF THE UNITED STATES THEY DID NOT GIVE A LOCATION NAME
 BUT THEY DID GIVE GRID COORDINATES THUS. UNLESS THERE ARE
 AIR FORCE GRID COORDINATES FOR THAT AREA THERE IS NO CLEAR
 INDICATION TO EXACTLY WHERE IT WAS. THE PHOTO DEALT WITH
 SPECIAL TEAM THAT WAS CALLED IN TO RECOVER A CANNON
 UFO IT ALSO DEALT WITH ALIEN BODIES + AUTOPSY REPORTS

Autopsy Type Photographs, High Quality, Color, 8x10, 5x7
 Photo #1 Showed A Alien Being ON A Autopsy Table Which Is
 A Metal Table With Runnels + Traps Underneath To
 Trap Fluid + Feces Body Appeared To Be Little Short Of
 4', Table About 7', No Clothing On Body, No Genitalia,
 Body Completely Aeternus, Head Was Rounded Cranium,
 Slightly Enlarged, Eyes Almond Shaped, Slits Where Nose Would
 Be + Extremely Small Mouth + Receding Chin Line, Holes Where
 Ears Would Be, Photo Taken At Angle, Side View, Looking At
 Body At 45° Angle, Left Hand Was Visible, Head Was Going From
 Right To Left, Body Was Right To Left Position, Head On
 Right Side, Eyes Appeared Oriental-Looking, Left Hand Smaller
 Under Than Normal, Wrist Coming Down Just About 2 1/2" Above
 Knees. Wrists Appeared To Be Articulated In A Fashion That It
 Allowed Like A Double Joint With 3 Digit Fingers + Thumb, Wrist
 Was Very Slender + A Palm Was Almost Non-Existant, The
 Thumb + 3 Fingers Were Direct Extension From The Wrist. Color Of
 Skin Was Bluish-Gray, Dark Bluish-Gray At Base Of Body There
 Was A Darker Color, Indicating Body Was Dead For Some Time
 Body Fluid Or Blood Had Settled To Base Of Body. This
 Indicates That Body Was Examined Before Beginning Autopsy
 Picture 2 Showed Beginning Stages Of Autopsy, Following
 Standard Procedure, Body Was Suit From Crotch To Just Under
 Chin + Green Viscous Liquid Was In Evidence. There Were
 Internal Organs But Could Not Be Identified. Photos Thereafter
 Concerned Specific Areas Of Internal Organs. Of What
 Appeared As Small Cluster Of Multi-Valve Heart Or At Least
 2 Hearts Within The Cadaver, No Accurate Description Of
 Autopsy Report. Or What Was Found Within Corpse Accompanying
 Photos. Indication That There Was No Stomach Or Digestive
 Track Per Se, Later Analysis Showed That Fluid Within Body
 Was Chlorophyll-Based Liquid Which Apparently Dealt With
 Photosynthesis Or Similar, The Report Theorized That
 Nourishment Was Taken In Through Mouth, However Since
 There Is No Digestive Track Or Anything Of This Nature,
 The Waste Products Were Excreted Through Skin. One Section
 Of Report Did Specify That Cadavers Were Extremely
 Opaque, But This Could Be Accounted For By Either Detritation
 Or A Number Of Things, But Theory Was That Waste Was Excreted
 Through Pores Of Skin. They Could Only Theorize In Report

BECAUSE THERE WAS NO XENO BIOLOGY, A REPORT BY DR. J. ALLEN HYNER WAS RECALLED VIVIDLY - WHICH INDICATED THAT HE HAD ALSO STUDIED THE INFORMATION PROVIDED BY THIS PARTICULAR CASE & THAT HE FELT THAT IT WAS INDEED A GENUINE UFO CAPTURE & SUBSEQUENTLY THE ALIEN WAS PART OF UFO. DR. HYNER WAS NON-COMMITTAL BUT DID HOWEVER SIGN THIS REPORT, ALSO INDICATED IN REPORT THAT HE DID NOT VIEW BODY PERSONALLY BUT VIEWED PHOTOGRAPHS & ACCOMPANYING REPORTS FROM AUTOPSIES. THE PHOTOS DEALT WITH A NUMBER OF BODIES WHICH WERE VIVISECTIONED IN VARIOUS WAYS. AT ONE POINT A HEAD WAS REMOVED FROM BODY & PHOTOGRAPHED & AUTOPSY WAS PERFORMED ON THE HEAD. THE CRANIUM WAS OPENED & BRAIN MATTER WAS PHOTOGRAPHED & WAS EVIDENT. INTERESTING THING ABOUT PHOTO WAS THAT THERE WAS RIDGE BONE OR DIVIDING PARTITION-TYPE BONE RUNNING DIRECTLY THROUGH CENTER OF SKULL AS THOUGH DIVIDING TWO BRAINS ONE FROM THE OTHER, THIS SEEMED APPARENT FROM PICTURE. THE SKIN WAS COMPLETELY REMOVED FROM CRANIAL STRUCTURE & THE SKULL WAS LAYED BARE AS MUCH AS POSSIBLE AT ONE POINT IT WAS DIVIDED ^{DIRECTLY} IN HALF & PHOTO SHOWED UNDERDEVELOPED ESOPHAGUS & NASAL CAVITIES NO CLEAR PHOTO OF EYE ORBS AS WE KNOW THEM, JUST PHOTOS OF COMPLETE VIVISECTION OF SKULL ITSELF, NUMEROUS PHOTOS OF FLESH OF THE BEING. STARTING WITH CUTANEOUS & SUBCUTANEOUS. MICROPHOTOGRAPHIC PLATES, APPEARED TO BE CELLULAR STUDIES DONE UNDER MICROSCOPE & ELECTRON MICROSCOPE TYPE PHOTOS, EXTREME MAGNIFICATION OF TISSUE SAMPLES.

RECEIVED

270

Who's Who of Aliens Visiting/Living on Earth
Terrans (of Earth)

1. Human appearing - these are beings which are ostensibly physical in form, appear to be living on earth, in disguise or genuinely human but are recent colonists, covertly or overtly executing missions or learnings, unconsciously or consciously. They can be medically identical or just appear the same. You would not know it if you saw and spoke to one.

a) Earth humans masquerading as aliens

- i) Secret government agency operations, - psychological warfare operations, anti-alien tactics, social control tactics, etc
- ii) Humans under covert influence of aliens - either from aliens living on earth, or from aliens using remote mind control from craft or other dimensions
- iii) 'Star-people' - from those people of the 'new age' type who are fashioning a relatively harmless identity, to real ones, to those who are trying to develop cult followings
1. Souls evolved from earth into human form are not star people
2. Soul's lived on other planets but have been on earth in humanity for numerous lifetimes are also not star people, strictly speaking
3. Souls lived on other planets and have only been on earth as human intermittently over the last many lifetimes - (semi)-star people type 1
4. Souls lived on other planets and been reincarnating on earth for just a few lifetimes consecutively - star person type 2
5. Souls lived on other planets and are here virtually for the first time but were born from an earth mother, and are here with some particular mission or self styled goal, study, learning, evolution - star person type 3
6. Souls from other planets who were not born on earth but rather happened to find a suitable human to 'walk-in' and reside

within, which human soul either left voluntarily or by force or is still in the body also - i.e. possession (positive or negative) - star person type 4

7. Souls who just 'visit' for a while in the body of a earth human, take it over, then release it back, usually on specific task assignment or experiment or study - star person type 5

8. Beyond this is 'channeling' and the human person is not 'hosting' the soul of any alien or entity but rather is receiving communication from them.

b) Aliens masquerading as humans

- i) Pleiadeans - a common 'source' reference
- ii) Gray controlled bio-drones, droids
- iii) Gray controlled MIBS/holograms, projections
- iv) Nordics - nordic/arian race forefathers
- v) Koldasians - similar level of evolution
- vi) Ashtarans - quite advanced technical
- vii) Others - certainly there are more

c) Aliens who are unconscious social 'plants'

- i) Pleiadeans - 'immaculate' embryo implants
- ii) Ashtarans - 'Jesus Sananda' 'confederation'
- iii) others

d) Aliens minding own business, isolated

- i) Pleiadeans - Quetzal from Heler contacts
- ii) Others - Nordics, Yeti, etc

e) Aliens minding our business, remotod

- i) Pleiadeans - under Ashtarans command
- ii) Kamagolians - 'Fatima' group

e) Earthkind descended from Aliens

- i) Different races, yellow, black, white, red, etc
- ii) Most recent - Basques

2. Humanoid appearing

- a) Dwarfs
- b) Reptilian
- c) Yeti, Bigfoot
- d) Safath
- e) Gray skin with large black eyes
- f) Dark large headed insect-like

3. Non-humanoid

(From Top Secret/ Apotheosis (c) 1989 Nexus Seven)

Extra-terrestrials

1. Human appearing

- a) Earth humans from another time/space
 - i) Future same space
 - ii) Future parallel world space
 - iii) Present parallel world space
- b) Aliens looking as human
 - i) Koldasians
 - ii) Itibians
 - iii) Ashtarions
 - iv) Pleiadeans
 - v) Dals
 - vi) 'Nordics'
 - vii) Gray controlled bio-drones
 - viii) Droids
 - ix) Others

2. 'Humanoid' appearing

- a) Smooth skinned
 - i) Akartians
 - ii) Iargans
 - iii) Others
 - iv) Orion Betelgeuseans
 - v) Talls
 - vi) Oranges
 - vii) Kamagolians type 2
 - viii) Human/Gray interbreeds
 - ix) Dwarfs
 - x) Hairies (yeti type)
 - xi) Umno's
- b) Scaly supersmooth skinned (Saurian)
 - i) Zeta Reticulans
 - ii) Orion Betelgeuseans (big nosed, medium eyes)
 - iii) Gray big eyes, no nose, 5 feet or more
 - iv) Gray big eyes, no nose, 3 feet tall
 - v) Green big eyes, photosynthetic
- c) Scaly rough skinned
 - i) Reptilian slit nose
 - ii) Reptilian with nose
 - iii) Reptilian with various color skins

3. Non-humanoid - unknown

Interdimensionals

1. Human appearing

- a) Earth humans from another time/space
- b) Aliens disguised as human
- c) Aliens from another time/space
- d) Projections/holograms
- e) Poltergeists

2. Humanoid appearing

- a) Many of extraterrestrials with dimensional travel

3. Non-humanoid

- a) Physical
 - i) unknown
- b) Semi-physical
 - i) EM spectrum limited
 - ii) Can periodically 'manifest' as physical
 - iii) 'Refined' physical, maybe not visible to all
- c) Non-physical
 - i) were humanoid/human at one time
 - ii) never humanoid, parallel dimension
 - iii) never physical, spiritual dimension



Handwritten symbols and text on a panel, including a triangle, a circle, and some illegible characters.

2	7	6	7	6	2
5	4	5	4	5	4
5	4	5	4	5	4
5	4	5	4	5	4

2	7	6	7	6	2
5	4	5	4	5	4
5	4	5	4	5	4
5	4	5	4	5	4

Primary Physical Characteristics of the Grey Entities

The big-headed Grey is the most commonly seen of the species by human beings. The evidence seems to indicate that they are subservient to the taller

Greys, which seem in many cases to be monitoring what the smaller ones are doing. Research indicates that these smaller Greys are clones that collectively possess an electronically monitored and controlled social memory complex that allows them to function effectively in a group-mind mode. They do not have distinct individuality, as the larger Greys seem to have. The approximate height of the big-headed Grey is 3.5 to 4.5 feet tall, and according to autopsy results gained between 1951 and 1978, they have an average weight of about 40 pounds.

The proportions of the head to the body are similar to a human five month fetus. This clearly seems to reflect a very ancient nature as a species as well as the fact that their DNA patterns lie within a specific band that is on a more primitive scale.

Species skin tone variation seems to be widespread, with skin colors ranging from bluish grey to beige, tan, brown or white. There are other factors which appear to affect skin color, and one of them is the state of general health of the entity. Skin color is known to change after they have consumed nourishment.

There are no reproductive organs or reproductive capability with the cloned species. The larger Greys apparently have some vestigial reproductive capability, and some of the hybrid species that have been cross bred with the reptilian species have full reproductive capability. The brain capacity is estimated to be between 2500 and 3500 cc, compared to 1300 cc for the average human. Due to the cloning process, the neural matter is artificially grown brain matter, and the Greys have known technology that enables them to insert memory patterns and consciousness into clones in any matter or pattern that they wish.

The Greys consume nourishment through a process of absorption through their skin. The process, according to abductees who have witnessed it, involves spreading a biological slurry mixture that has been mixed with hydrogen peroxide (which oxygenates the slurry and eliminates bacteria) onto their skin. Waste products are then excreted back through the skin. Many abductees have noted that the Greys have a distinct series of odors, many of them appear to be similar to a metholated cinnamon smell.

The larger Greys have a more pronounced nose and are more human in appearance. According to some government sources, these extra-terrestrial biological entities called themselves the EBAN. It is with the larger Greys that elements of the government made a series of diplomatic agreements in the 1950's, 60's and 70's.

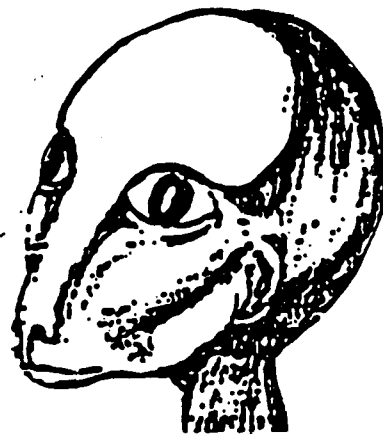

ENTITY SUMMONED BY DR.
JOHN DEE IN 18th CENT

ANATOMICAL DETAIL OF EBE HAND

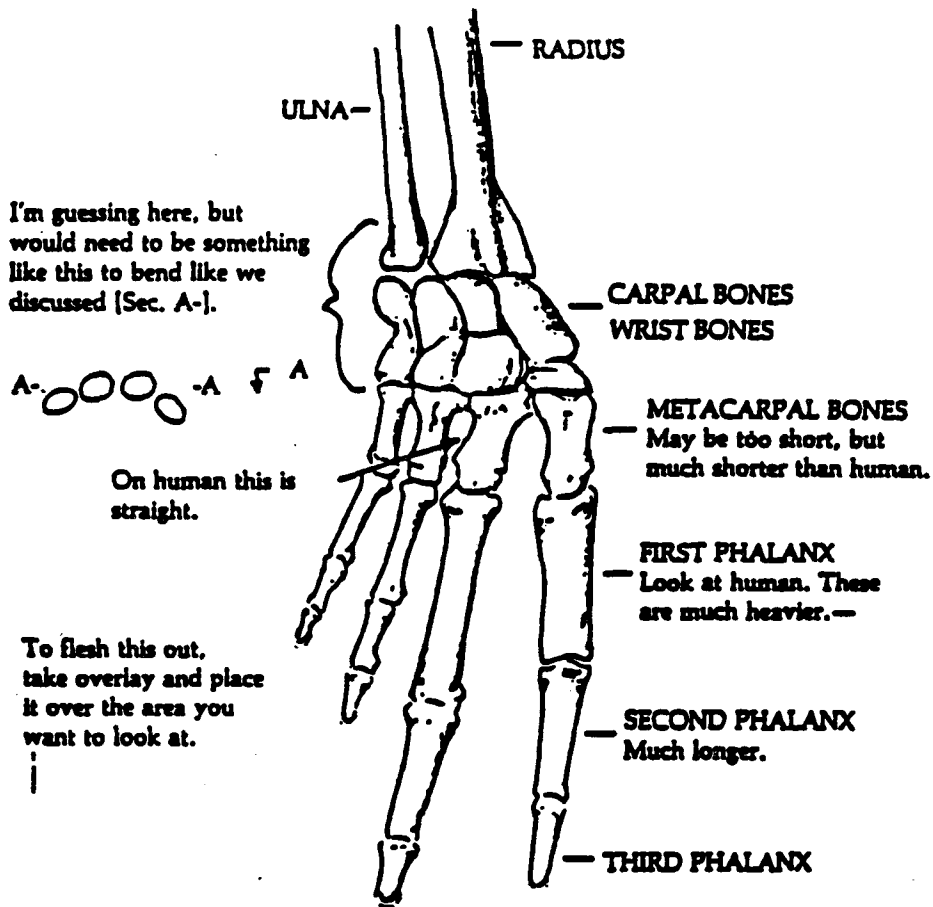

The above illustration depicts a skeletal hand structure of an alien hand. This was allegedly verified by a former CIA employee in 1978 who claimed to have seen deceased aliens during a recovery in New Mexico. The drawings are circulating in underground circles.

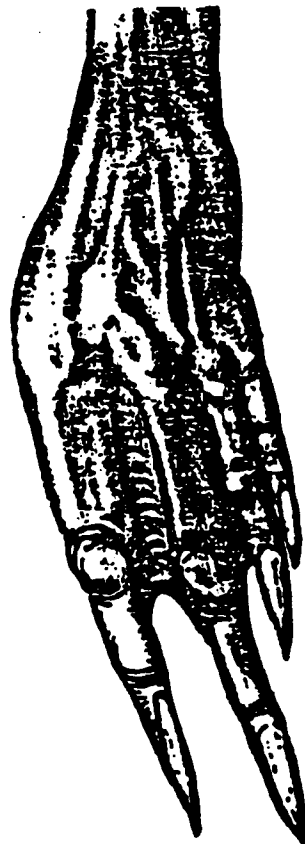

COMPOSITE OF AUTOPSY FINDINGS ON
SOME ALIEN SPECIES

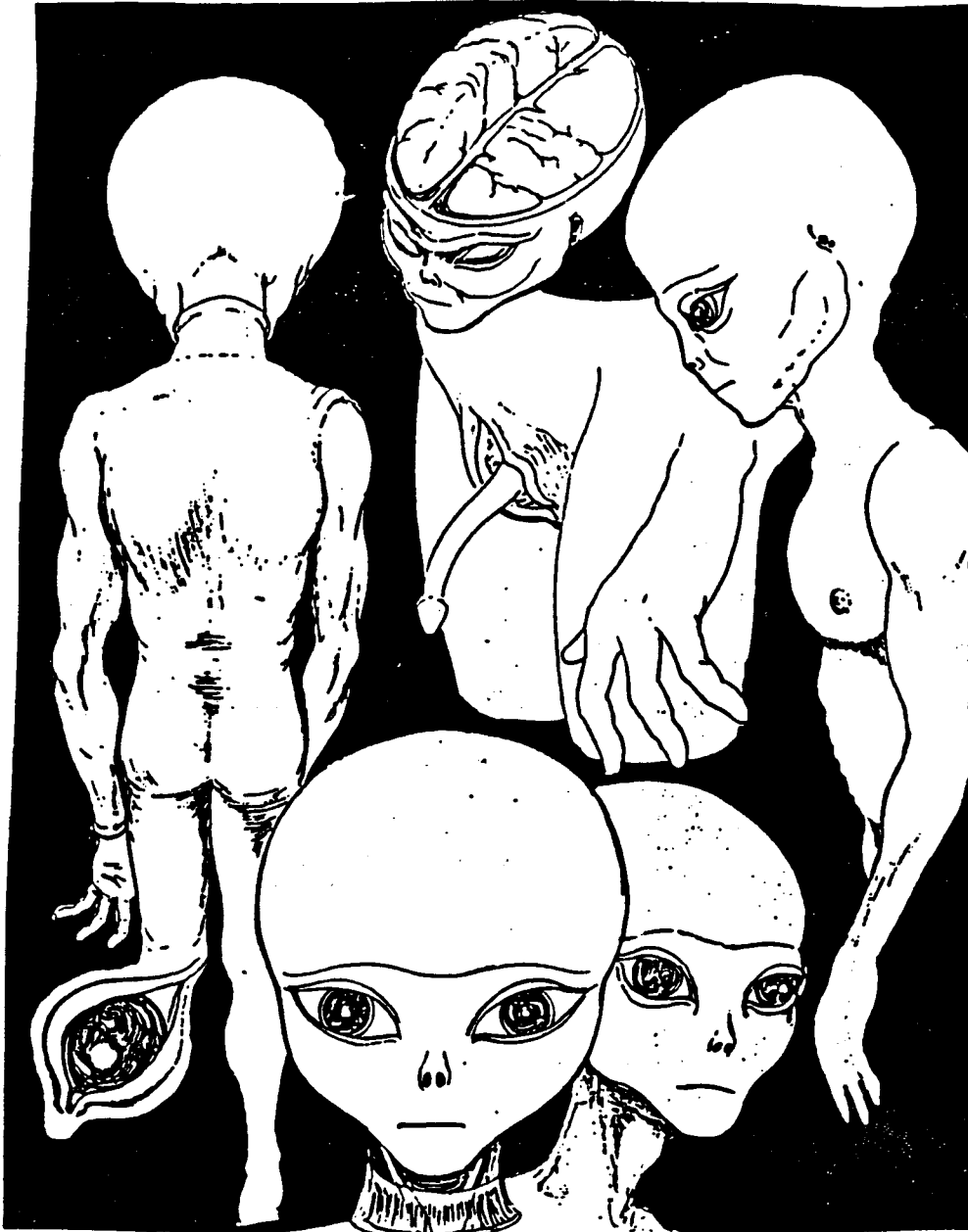

(c) Chan Johnson 1988

The larger Greys have a more pronounced nose and are more human in appearance. According to some government sources, these extra-terrestrial biological entities called themselves the EBAN. It is with the larger Greys that elements of the government made a series of diplomatic agreements in the 1950's, 60's and 70's.

It might be noted at this point that we are not really dealing with "superior" beings on an evolutionary scale when we are speaking about the Greys. They and their various cloned offspring should be considered as a lifeform. Their technology is what gives them a temporary superiority. An interesting comparison to the Grey species is the dolphin, which is an intelligent species which has a group consciousness shared through telepathic means. The dolphin brain is some 65 million years ahead of the human brain in cortical development, yet the dolphins maintain a social structure that is totally without tools and devices. The variations seem endless.

Reproduction Processes

Innumerable witnesses have confirmed the presence of underground facilities that the Greys use for breeding. These facilities, of which Dulce is the most famous, provide for genetic work of all descriptions. Humans are brought to these facilities on a continuing basis in order to provide a genetic pool from which to extract DNA and RNA mixtures that will contribute toward the efforts of the Grey species to strengthen their genetic structure. Cloned species have a distinct disadvantage, in that the cloning process provides for increased DNA replication failure. It is thought by many that the Grey DNA structure is so degraded that the species is functioning on more of an RNA basis. With RNA replication there is no cross-checking capability during cell reproduction.

Biological Materials and Animal Mutilations

The Greys secure biological raw materials from lifeforms on Earth for their genetic work. So many researchers state that the aliens are doing genetic "experiments". They are not playing around - they know exactly what they're doing, and it is more like a "labor of love" than experimentation. The animal mutilations provide, when reduced in the lab, DNA, RNA and other materials, as well as different kinds of tissue. Tissue extracts taken from cattle intestine, for example, are absorption-based tissue. Other tissues excrete hormonal substances. Artificial brain matter is grown in containers or vats that appear to be electronically stimulated. In some cases, humans are killed and tossed into the vats. In two cases, dead humans have been seen floating in vats right next to the body parts of cattle. Human mutilations appear to be less obvious than cattle mutilations, although both still continue to this day.

ANIMAL MUTILATION INVESTIGATION

Whenever a fresh animal mutilation is discovered, immediately telephone:

John H. Altshuler, M.D. - Home: (303) 771-6687
24 hr answering service: (303) 740-7771

Linda Howe : (303) 694-9749

Findings that suggest animal mutilation is worthy of further investigation:

1. Animal with "cookie cutter" incisions, i.e. cuts that are sharp, well defined and with smooth edges.
2. Cored out incisions in rectal or genital areas.
3. Removal of body parts particularly genitals, ears, tongue, heart, extremities.
4. Absence of blood in or around animal.
5. Removal of flesh to bone especially in lower jaw. The bone is stripped of all flesh to clean bone even in animals dead for 12 hours or less.
6. In the area where the animal is found, finding of unusual soil condition such as hard or baked appearing soil.

PROCEDURE FOR ANIMAL MUTILATION INVESTIGATION

1. Telephone Dr. Altshuler or Ms. Linda Howe
2. Photograph the animal at its location before moving it.
3. Photograph incision regions. Color photography is preferable for all photographs.
4. Cut relatively small sections through the hide (skin) in the areas where mutilation incisions have been made. These sections with tissue removal is done should be done perpendicular to the incision line of the mutilation cuts so that abnormal and normal edges of incisions are made available for testing. See diagram.
5. Removed tissue should be placed in 10% formaldehyde. Formaldehyde may be obtained from any hospital laboratory.
6. The tissue in formaldehyde should be sent by UPS or Federal Express to:
John H. Altshuler, M.D.
Greenwood Executive Park
7485 East Peakview Avenue - Bldg. 10
Englewood, CO 80111

With the tissues be sure to include your name, origin of the tissue (animal and site) and any details regarding the mutilation. Shipment expenses will be refunded to you.

PROCEDURE FOR TAKING TISSUE SECTIONS OF MUTILATED ANIMALS

The photograph and diagram below show how tissue sections should be taken from mutilated animals. Note the dark bars representing the way tissue sections should be removed. Use a sharp blade, preferably a single edge razor blade. Cuts for tissue removal should be made perpendicular to mutilator incisions. Tissue removed should be placed in 10% formaldehyde as a preservative. The specimen(s) need not be refrigerated.

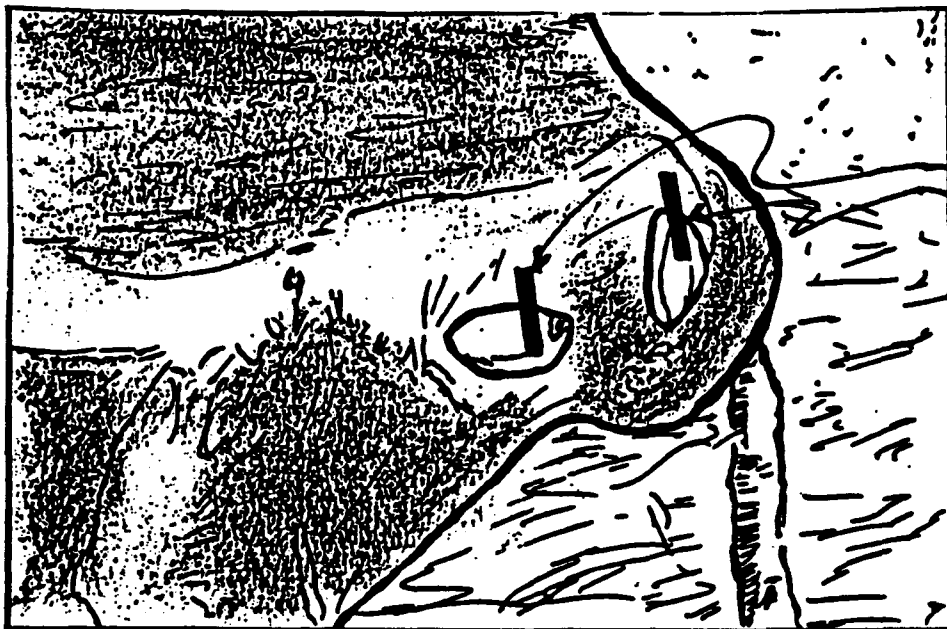

Arrows indicate where sections are to be removed

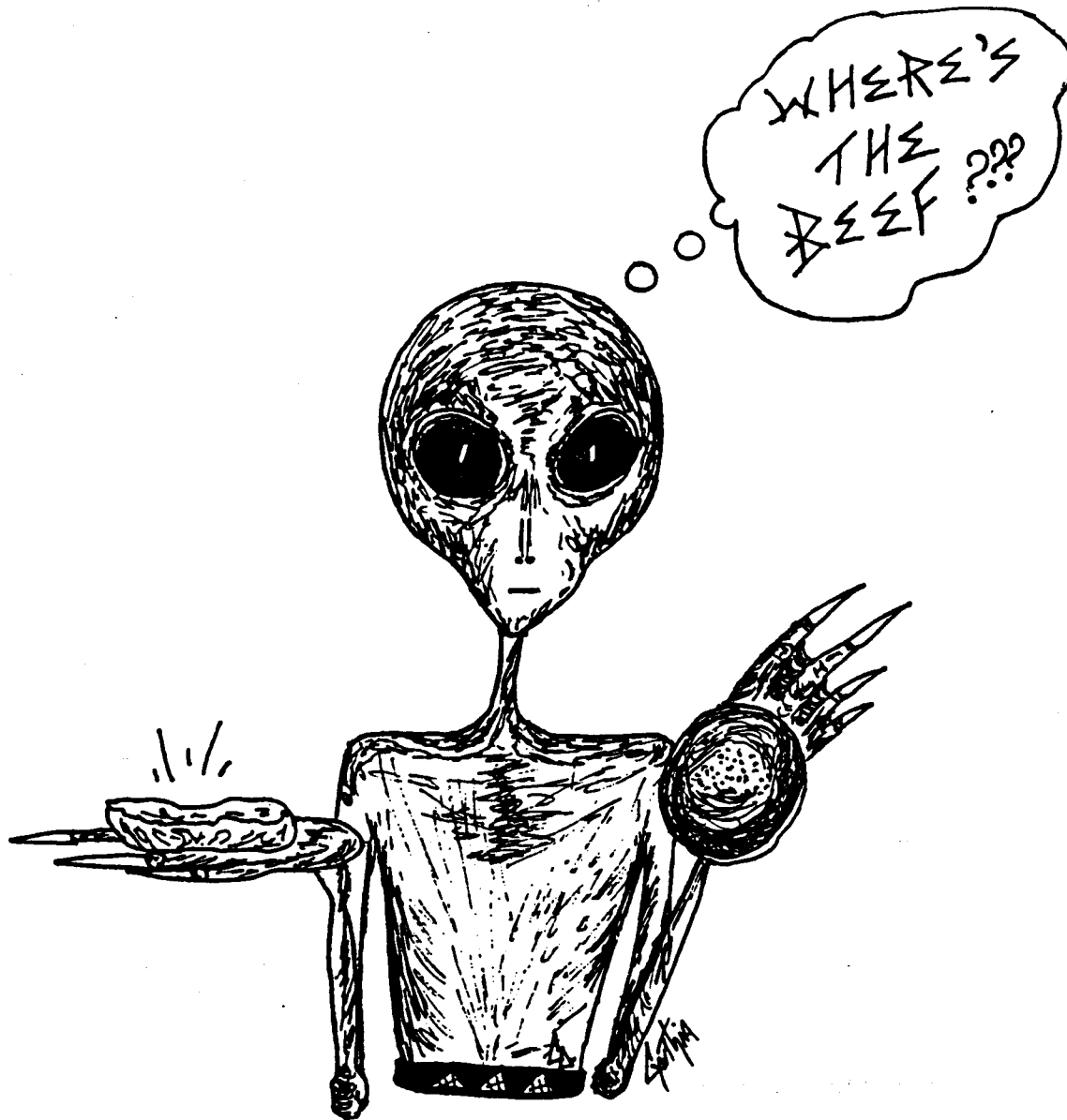

**Researcher Beaten Up by MIB/CIA
May 1990**

Researcher Jefferson Souza arrived at a UFO Conference in May of 1990 bearing information that included data about which corporations were producing helicopters with gravity assist, as well as information about *their use in cattle mutilations*. Four men appearing like classical MIB, believed to be CIA operatives, beat the hell out of Souza, took the documents, and threw him back on a plane to New York. It may well be that CIA/Delta/NRO involvement in the mutilations might be more significant than supposed. Now the question remains as to why the government would be carrying out or participating in this large scale program. Whose interests are being served ?

**Other Concepts Regarding the Greys
as Essentially Positive or Neutral**

One of the more interesting scenarios that exists regarding the Greys is one that has several components that:

(1) Assign them the role of "caretaker" of the human species. This scenario is in direct opposition to many of the other scenarios regarding the Greys, but it does have a lot of points that deserve attention. Within this role, the Greys seem to be performing several sub-tasks:

- a. Analyzing selected human gene sequences (through multi-generational abductions of human family lines having a specific genetic sequential format)
- b. Periodically rearranging the genetic coding in specific humans in order to create new genotypes within the human species. Some researchers have stated that this has been done more than 60 times since the human species was created over 250,000 years ago. A major genetic shift occurred about 30,000 years ago - right at the same time that the Neanderthals mysteriously vanished. This is an example of a "gross" change. The changes that the Greys are implementing and researching now appear to be more subtle (but no less far-reaching) ones.

(2) Assign them the role of "preservers of lifeforms" relative to this planet. Several types of activity seem to be sub-tasks under this role:

- a. The gathering, sampling and analysis of various lifeforms on the planet. Research has already established that the Greys, amongst others, have been constantly performing this function, which seems to be related to constant checking of status.
- b. Gathering of lifeforms from the planet prior to a geological upheaval. Upheavals of various nature have occurred again and again through different successive "waves" of civilization on the planet.

(3) Acknowledges the fact that the Greys are cross-breeding with human beings in an attempt to re-vitalize the genetic structure of their species. Any species faced with their genetic dissolution would do the same if their technology could accommodate the process. This activity has been going on for a long time and has produced many generations of cross-breeds. These crossbreeds are potentially more superior in function than either humans or Greys.

Parallel Evolution as reflected in Humans and Greys

First of all, many individuals have seen breeding labs, both underground and on spacecraft. In those labs, Grey fetuses can be seen. Those fetuses have heads that are "out of proportion" to their body as compared to humans.

It is interesting to note that human heads are getting larger as health care and other facilities permit greater fetal development at an earlier age - more and more births require a Caesarean section. Heads are generally moving toward being too large for the birth canal.

Down the road, humans will no longer be capable of giving birth in the normal way. Fetal heads will be too big for the birth canal and the pelvis of the human to accommodate. What will humans do then? Artificial wombs?

The idea was brought out on the cover of Life magazine in 1965 - the equipment looks similar to the artificial womb equipment used by the Greys. Moving toward an artificial womb situation would avoid the problems and limitations placed on brain development in an enclosed womb. It also opens the door to artificial selection and genetic engineering, which are being pursued now in the wake of human genome research and sampling of amniotic fluid to tell whether the fetus is diseased or malformed. A Grey fetus and human fetus look the same.

It is pretty certain that brains and skulls evolve toward a larger size. Is this a universal problem that every species must eventually deal with?

Indications are that it may be just that. It is the reason that the Greys are using human females to bear their young during the first 90 days - the physiology of the Grey female no longer allows them that convenience. Indications are that the Greys place great importance on their children - the future of their race, and have demonstrated an interest in human emotions relative to "mothering" and human relationships to children.

Questions That Still Need Resolving

- (1) If the Greys are in fact caretakers of humans on Earth, what is their real relationship with the Reptilian humanoids which are known to be dominant over them and known to consume humans?
- (2) How do we explain the fact that the Greys are involved in the stockpiling of humans (including children) for use as a food source for the Reptilian species (and as a lesser food source for themselves)?

- (3) How do we explain synthetic cloning of human beings in order to gain control over planetary power groups? The Greys are known to be involved in this procedure.
- (4) How do we explain the apparent destruction of lifeforms and the Service to Self mind-set? Is it only a matter of perception on the human side? How do cattle view the humans that slaughter them? If they had enough awareness, would their demands then seem valid to humans?

Producing Hybrid Organisms

Production of hybrid organisms involves a process whereby normal physical development is bypassed and sexual maturity is achieved in the fetal state. This process is known in current genetics and produces leaps of structural difference. One can use the same basic genetic coding and change the rate at which the gene functions in order to achieve a wide variance in life forms. It is apparent that humans and Greys are, in fact, genetic variations of the same life form.

Other human-appearing aliens with advanced technology could have taken a simian fetus and made structural changes in their own image in order to produce the original Homo Sapiens, which has been altered many times since.

Who's In Charge Here?

There are two main thoughts with respect to the Greys and who they may work for:

- (1) The Greys work for the Taller Greys, who work under influence from a Reptilian species, who left them in charge when they left several thousand years ago. During that time, the Greys have discovered their independence and do not wish to be re-enslaved by the Reptilians when they return. This supports the known observation that abductees are being trained on alien equipment. To fight the Reptilians? The other humans who were the original "creators"?
- (2) The Greys may be independent of all of this, having the ability to travel in time and space. They may be working for no one but themselves, trying to improve their species and take what they can take from the planet. They have been referred to by many as mercenaries. There are no doubt different groups of related species with different motives and mind sets.
- (3) According to the "caretaker" scenario, the Greys would be working for the "blond" humanoid species that made the original effort at producing the human species.

The Greys as an Electronic Space Society

It has been our experience that the majority of the public has a mind set which is not predisposed toward understanding anything outside the cultural reality they are surrounded with, and this makes our task only that much more interesting when it comes to trying to educate people about themselves and the universe around them. Alien interaction only complicates this process. We have taken years of material, right up to the present, and have condensed the material so that the reader will be getting as much knowledge as possible.

For the last 20 years, we have examined the situation very closely, and we have had information from many sources. Much of the information has evolved over the last three years - much of it is still coming in. Information is verifiable, either by the overwhelming corroboration from widely scattered sources and the synchronicity of events, or from individuals (including US Government military and intelligence forces), including abductees, that have been directly involved with what is happening. First party sources.

One of the largest problems over the years has been identifying the perpetrators of these abductions. There are two kinds of abductor: (1) Non-Homo Sapien forces (2) Terrestrial forces, primarily intelligence and security forces of the government and corporate entities.

A General View of Space Societies

Among the Non-Homo Sapiens (NHS) forces, it has pretty well been established that there are over 70 species interacting with this planet, there are 9 that are most active. Out of those 9 there are primarily 4 species that are deeply involved in abduction of humans for various purposes, and these are (1) The race commonly known as the Greys (2) Blond humanoids (3) Red-haired Humanoids (4) Reptilian humanoids.

Sources for NHS entities are quite varied. It appears that entities have these as some of their sources:

- o Different sectors of space, both on and inside planets and planetoids/moons.
- o Different harmonic frequency bands and dimensions for matter and energy that are outside the perceptive range of the Homo Sapiens and also outside linear matter, energy, space and time.

All the NHS entities have displayed societal structures which portray a large variation in species, most of which seem to have passed the point of evolution that this one is in, and many of which (especially the Orion-based species) make heavy use of crystalline and light-based technology, as well as implant and mind control technology. Abilities to manipulate mental energy are what separate the abductee from dealing with the Greys on their own "turf".





Crystalline Biological Structures

During one of the autopsies on alien bodies, it was found that there existed a separate lobe of the brain that contained a crystalline network. This, to me, was an interesting discovery, for it made the connection with other information which we already possess about such networks. During examination of data from ancient texts, such as the Keys of Enoch, we can see that the networks are pertinent to advanced physical forms, and that these networks allow them to tap into the Universal Intelligent Matrix. In these ancient texts, brains of advanced physical beings, presumably those of 3rd and 4th densities that require the use of physical bodies, are described as having the right and left hemispheres of the brain fused and a small frontal lobe which acts as a "crystal recorder" structure, or third brain. This is exactly what the autopsies found.

With this data in mind, it might be presumed that the development of the network structure is a later physical manifestation that occurs subsequent to the development of 4th density telepathic abilities. Within the human, a structure known as the caudate nucleus functions as an initial structure for establishing telepathic communication. The term antankarana, or bridge in the brain, refers to the evolutionary connection of the caudate nucleus with the rest of the brain.

Thought forms pervade the universe, and evidently it is this network which allows a being to tap into the matrix and gain information. The matrix, or Universal Intelligence Matrix, pervades the universe. It is a hierarchically ordered intelligence-field composed of infinite domains, dimensions/densities/parallel worlds, and conscious entities. The primary function of the matrix is that it enacts the thought patterns of the Universal Mind into manifestation. The resultant diversification exists as an infinite spectrum of interconnected combinations and permutations.

Interdimensional communication is the result of attunement to one's own network so that it functions as a multidimensional extension through which communicative access to desired aspects of the matrix can occur.

Development and evolution of neurological pathways in the brain is a process during which brain cells expand, crystalline domain orientations shift, and neurocircuitry pathways are gradually overridden. The pathways upon which this development takes place is sometimes esoterically termed the Urim Circuitry. This circuitry is now mostly dormant in humans, but can be stimulated ahead of its normal evolutionary progression.

Interdimensional communication is the birthright of all beings. As every being evolves, the communicative capacity is heightened along with the awareness of its abiding essentiality, and this process is what some alien forces who are in control of the Earth are trying to retard; other groups want to stimulate the process to help humans achieve a greater focus in 4th density, with the accompanying moral and spiritual development.

The human skull contains internal structures which are resonant liquid crystal-colloidal membranes. These membranes and structures respond to the spectrum of the Universal Intelligent Matrix by reacting to standing wave interference patterns.

Some have stated that use of interdimensional craft by humans is not possible because of the physical development (cranially) of the human, which does not permit focused mind-linkage. Mind-linkage permits a grouping of beings to be "of one mind" and focus the technology to permit transfer of the equipment and themselves to other locations, domains or densities.

This discussion lays the groundwork for a discussion on one of the more important areas: Light-based technology.

Light Based Technologies

The use of crystalline matrices to modulate energy, consciousness and matter is the hallmark of the most advanced technologies. This technical capability exists in many of the species that are not indigenous to our planet, and many beings on our planet are, and have been, subjected to modification of their psychic and genetic patterns using this technology.

The Andreasson affair was a good example, in that it illustrated some of the technical capabilities that are being imposed on humans to achieve ends that are as yet unspecified. The human body, a resonant bioelectronic crystalline structure, can be deeply affected by patterns that are entrained upon it. Learning can be achieved - or taken away. The biological state of health can be improved - or degraded. We are dealing with a system of science that has its roots in a deep understanding of how the universe and reality systems operate, and it is quite evident that humans are beginning to recall some of those factors. There is an implicit knowledge of spiritual functions that is coincident with knowledge of crystal and liquid-light based technologies. Apparently, most of the beings that use this technology are at least 5th density, and have the capability to resonantly energize the human biological system to raise the density level in order to apply the technology to the human system. We have had underground areas described to us that contain green cylindrical chambers with seats, similar to those discussed in the Andreasson affair, and one of the locations of those chambers is right outside of Las Vegas, Nevada. The function of these chambers is to increase the vibratory resonance of the physical body to transfer it to a higher density level, interact with the individual, and return it to its normal density after the interactions are accomplished.

For your information, a good literary source for details regarding crystal based technology is "The Crystal Connection", by Baer and Baer.



APPEARANCE OF REPTILIAN HUMANOIDS

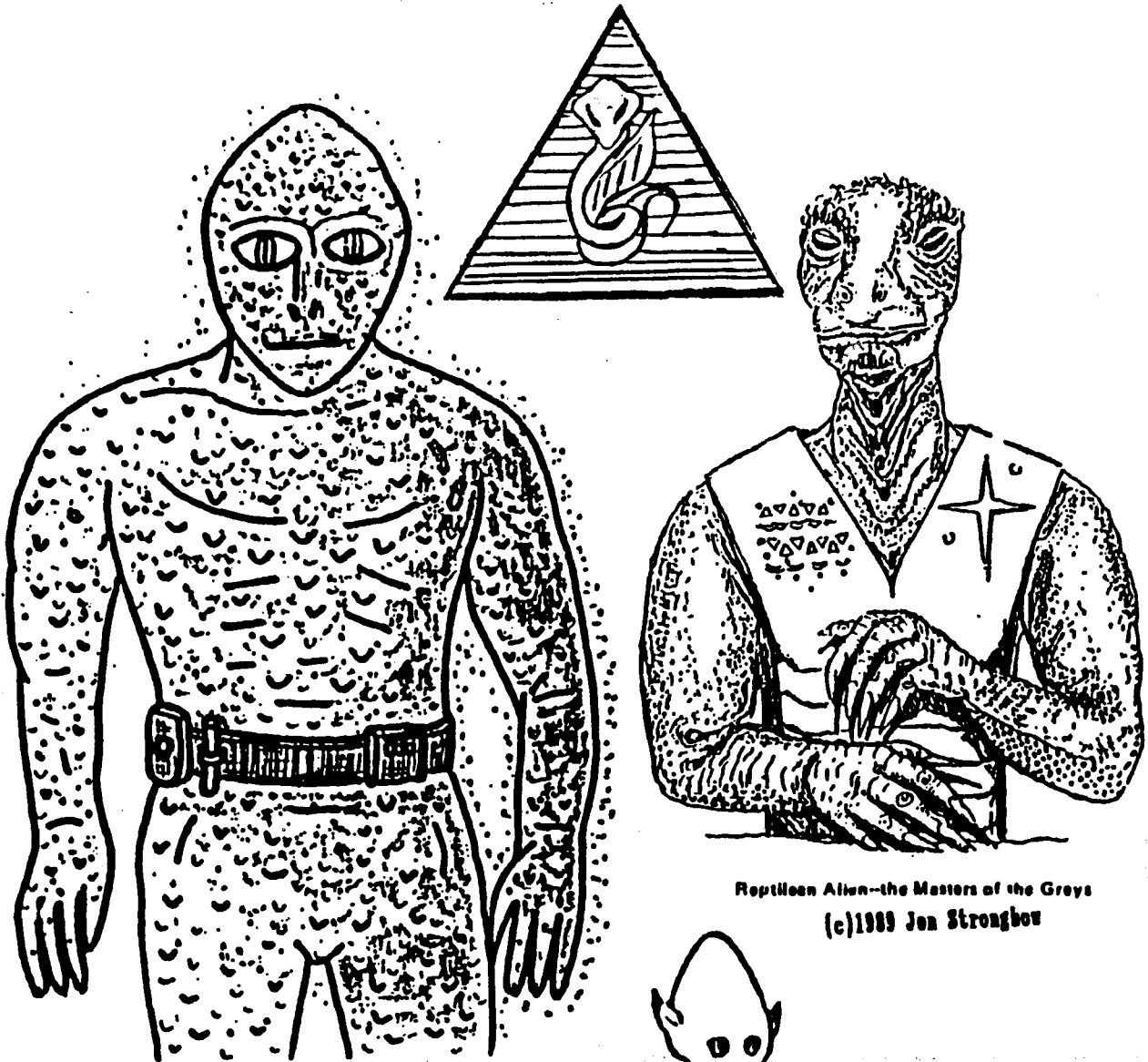

Reptilian Alien--the Masters of the Greys
(c)1989 Jon Strongbow

This group is primarily in dominance over the Greys. The elite of this group have winged appendages on their backs, but are rarely seen. The "mothman" researched by John Keel may be an example. The symbol at the top is similar to the basic trilateral symbol, but is more detailed and has a winged reptile in the center. Many Grey splinter groups have become independent of reptoid control. The Draco are included in the reptilian grouping.

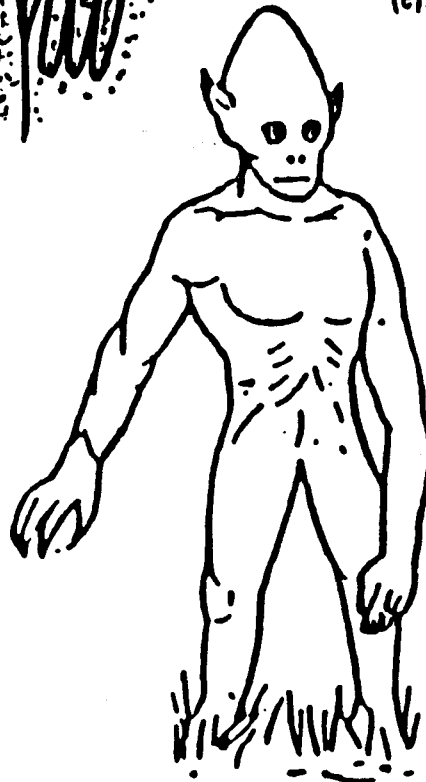

Greys with "normal" sex organs

There are evidently some Grey species that have full use of sexual organs. Most references to Greys as sexless beings are those that refer to the cloned worker class that perform most of the work during abductions. Breeding in large glass cylinders is believed to be the result of limited physical capacity to actually bear a child on the part of the Grey female.

It is apparently more practical to combine Grey sperm with a human female egg and allow it to come to a stage about three months old before removing it to complete its development in a similar liquid environment, which also has special light conditions which promote alien cellular development.

Pictures in the Dulce labs portraying wombs with little fetuses and the clear tubs with little aliens in them are believed to portray the cloned worker class of beings that are pictured on the cover of "Communion".

The tall Greys are the dominant species and are basically "test tube" species. The clones are synthetically produced with biological materials (much of which owe their source to lifeforms on earth).

Generally, the Grey clones have one major organ which has the combined function of a heart and lung. The rest of their body is apparently a homogeneous spongy tissue infused with circulatory systems, glands and other amorphous structures.

The brain has been described as having many more lobes than the human brain. There have been previous references to crystalline networks that have been found in the brains of some of the alien autopsies. It is believed that the network has a functional relationship to telepathic communication and acts as a functional node for group control of the cloned species, which function in what is essentially a hive mind.

Each of the Grey clones has an individuality, but it is much less pronounced than in the human, where tendencies toward expanded awareness and shared consciousness are minimized through cultural conditioning, programming, and basic cranial differences in structure.



Physiological Characteristics of Some Grey-Reptilian Species

Autopsied by the United States Government

(c) 1990 N.A.R.

(Alien Life Form) : Term used by the government to describe the Greys' in terms of being a malevolent life form. The deal with the Greys is that their field around their body is different from ours to the point where merging of the fields ends up creating physical symptoms (the "body terror" mentioned by people like Whitley Strieber). The field around them is in direct opposition to ours. It is an anti-life field, as these specific species are on a devolutionary spiral. They are akin to soldiers of fortune, and offer their advanced technology in trade for things they require. They are experts at manipulation of both the human body (through manipulation of the fields) and the human mind. They require blood and other biological fluids to survive. They abduct humans and animals in order to acquire these fluids. They implant small devices near the brain which potentially gives them total control and monitoring capability. These devices are very difficult to detect. The analysis of the devices by technical staff has produced a description that involves use of crystalline technology combined with molecular circuitry and these ride on the resonant emissions of the brain and the various fields of the human. Information is entrained on the brain waves. It appears that all attempts to remove the implants (1972) have resulted in the death of the human. They perform surgery and other operations on human subjects. These abductions continue to be an ongoing matter. A list of abductees is provided periodically to MAJI, although it is known that many more are abducted than are reported. These aliens also claim to have played a very significant part in the planets religious history, and have provided MAJI with supporting evidence of this. Various descriptions of the ALF's relate the following characteristics: Between 3 to 5 feet in height, erect standing biped, small thin build, head larger than humans, absence of auditory lobes (external), absence of body hair, large tear-shaped eyes (slanted approximately 35 degrees) which are opaque black with vertical slit pupils, arms resembling praying mantis (normal attitude) which reach to the knees, long hands with small palm, claw-like fingers (various number of digits- often two short digits and two long, but some species have three or four fingers), tough gray skin which is reptilian in texture, small feet with four small claw-like toes, organs that are similar to human organs but have obviously developed according to a different evolutionary process; a non-functioning digestive system; two separate brains; movement is deliberate, slow and precise; alien subsistence requires that they must have human blood and other biological substances to survive. In extreme circumstances they can subsist on other (cattle) animal fluids. Food is converted to energy by chlorophyll by a photosynthetic process (this supports results gained from autopsies at 29 Palms underground base where it was seen that their "blood" was greenish and the tissue was black). Waste products are secreted through the skin. The two separate brains are separated by mid-cranial lateral bone (anterior and posterior brain). There is no apparent connection between the two. Some autopsies have revealed a crystalline network which is thought to have a function in telepathic (and other) functions which help to maintain the group-consciousness between members of the same species. Functions of group consciousness in this species does have a disadvantage in that decisions in this species come rather slowly as the matter at hand filters through the group awareness to those who must make a decision.



THE GREYS AND THE REPTILIANS

This initial report is concerned with two groups of aliens: Greys and Reptilians. There are several different kinds of both Greys and Reptilians, but for now I will simply refer to them as single groups. Both groups live on this planet or beneath its surface and in space. They have been here for a long time.

The Greys are also "working" for Reptilians, relative to the abductee as an individual and to the human race as a whole. They have been used by the Reptilians as the middlemen, doing the work and exposing themselves to us on behalf of and instead of the Reptilians. The Greys are consistently referred to as a mercenary force, though they themselves will often say that they "have no choice", that they themselves are the slaves, presumably in their own culture or to the Reptilians.

The Greys are engaged in abduction and related activity, as they tell it, in order to survive. A great deal of the above is relative to their survival on an individual basis. They don't eat humans, but they use biological substances from humans (such as glandular secretions) in a manner we can compare with eating. (They absorb nutrients through their skin.) They milk us in the way we milk cows and they need what they take from us, or think they do. As a species, they are using material from us to recreate themselves, by creating their next generation with hybrids. Most of them can no longer individually produce offspring. I've been told that only one in a hundred or a thousand Greys can even conceive and that most of those babies do not live.

Some Reptilians, on the other hand, eat us like we eat chicken. In the United States, there are rumors of great, underground food-storage rooms full of preserved human bodies. Sometimes the rumor has it that the bodies are those of children. I asked the Greys why, if this was true, would it be children? I was told that it is not only children but also adults that Reptilians eat. Children are preferred because they are generally unpoisoned by substances like caffeine, nicotine, alcohol and other things adults are saturated with, as a group.

The Reptilians don't seem to be dependent on us as a food source, although part of their experimental work with us is toward the end of future food supply/production. When they become involved with crossbreeding (humans and Reptilians), they are not doing it for racial survival but for the purpose of creating a subclass (slave race) within their own culture. These halfbreeds are to be biological war machines and laborers, etc. They are to be someone else's property. Most contemporary monsters or oddities (such as the Cabbit,

half-cat-half-rabbit, that was found in New Mexico in the 1970's) were probably created by or are otherwise related to Reptilian and/or government genetic research.

The Reptilians seem to have little regard for us as living beings. (They think that we are as ugly and repulsive to them as we ever portrayed them to be, and that we, the human race, are "as valuable as weeds.") However, they do seem to consider some of us valuable property. One gets the feeling they will continue to use us as they see fit, or, if we ever become a real problem as a group, they would sooner wipe us out than deal with it. They do not fear us, considering themselves far superior to us by all comparisons. They supposedly consider the surface of this planet to be a poisonous, inhospitable environment and "allow" us to live here, since they live below the surface and in space. (We and our surface environment function as a physical buffer or living shield around their home underground.)

The Greys sometimes treat us more like children than animals. They consider us physically beautiful and healthy; mentally young and fresh. They do fear us, contrary to what they may claim, because they do not understand us. (They have no emotions or individuality; they are of a group mind. Socially and culturally, Greys and humans are very different.) They also fear us because they know we are potentially powerful beings. However, they insist that they "own" us: They say they created us and therefore have the right to do what they will with us. Beyond this original "right" to interfere with us, they say they have additionally earned the right through their control. Because they can control us on an individual and cultural basis both physically and mentally, they say they "own us".

These attitudes are propaganda. Their control over us in any capacity is ultimately very frail due to its very nature. Their control is based on intimidation and advanced technology. As we become more aware, we are harder to control, harder to lie to, harder to confuse. Our technology would definitely be competitive with theirs if we had access to it. Much of the technology we would need to effectively overcome this situation exists now. It just isn't made available to the public, for economic reasons, as well as "national security."

The preceding statements about the Greys are based on conversations with them and long observation of them. Impressions about the Reptilians are more general. I have not engaged in conversations with Reptilians, though they have sometimes spoken to me. Most of my experience with them does not include direct communication between me and them. Almost all of my consciously recalled memories of Reptilians also include Greys, who usually do the communicating between us. Often the Reptilians seem to be present during abductions as observers only, standing off to the side of the action, just watching.

Physiotype of Grey-Reptilian Alien Responsible for Abductions

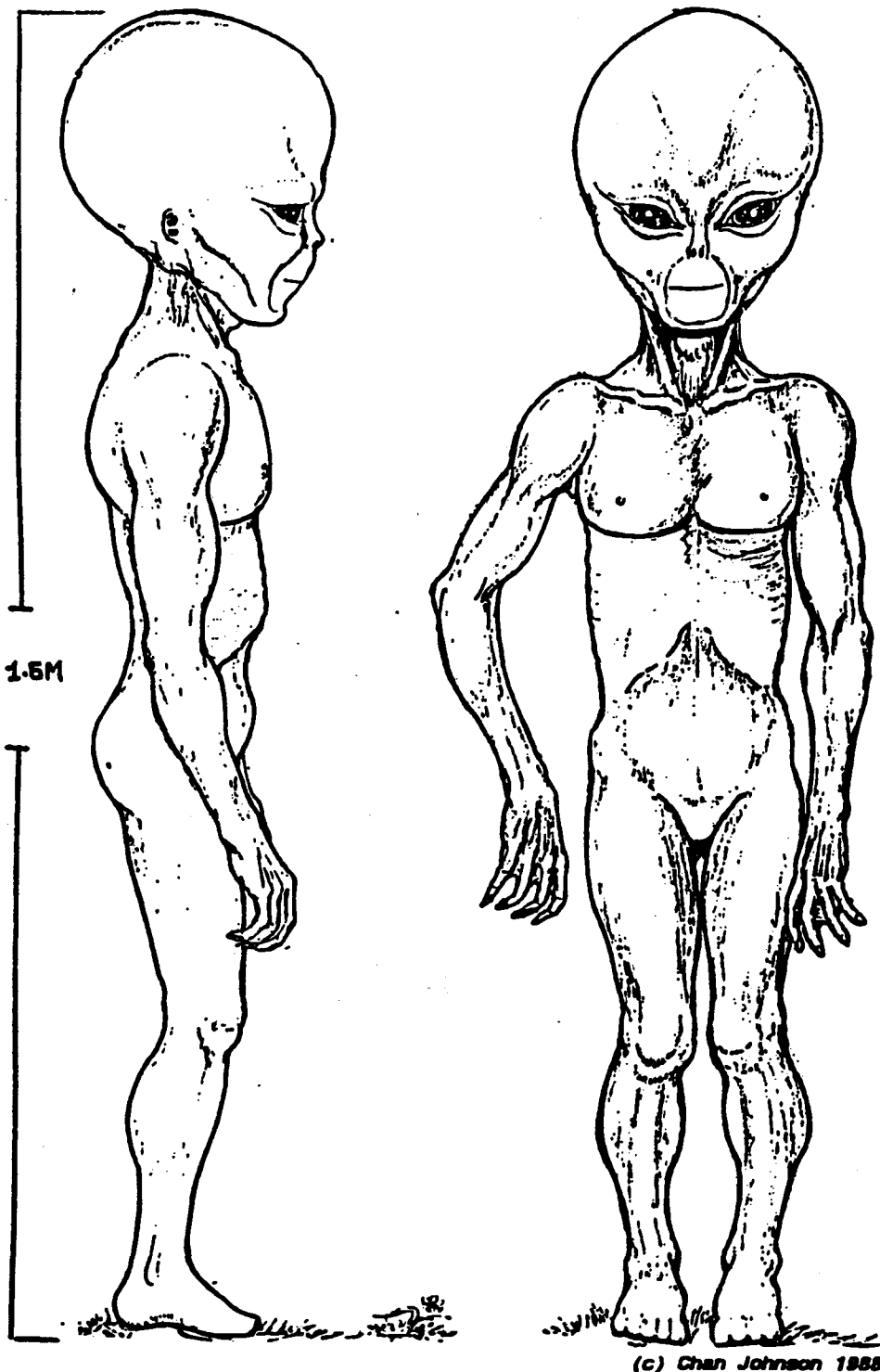

The entity pictured above appears to be a cross breed between the Grey species and the Reptilian species. Note the mandible-like formation around the mouth and the ridges over the eyes and along the skull. Also note the 4 webbed fingers as opposed to 3 in the less complex species.

CHROES DIELECT OF THE RETICULAN SPECIES

A	EM	DE'	WIL
MU	ITH	ZUN	ES
PIE	XOF	JAK	ELV
SU	SAL	KAI	MOOL
TIE	LNEH	AKA	LAGO
KU	SHA'	ULO	ROAE
LA	TRA	COM	AF
ATI	KUN	EI-NE	KUER
PH	LOH	E-HEN	BOS
BE	YAR	AMI	DOSEM
EE	MON	NOS	MENK
DO'	TNEZ	EIOS	MERMA
NIF	TRAS	BOT	BU
BINT	AEM	DAMI	TSOU
UR	GHU	KOG	KOB
HNG	SHOR	EWE	LUPC
KNC	ARA	UERN	XIS
ANL	KE	SAL	NOE
LU	OK	ITE	CEN
MER	DUM		
TSING	WAN		
FE			
JUCH			

CHROES DIELECT OF THE RETICULAN SPECIES

AE	o/o	DING	+	P.R.		MELB	
OROM	5 4 0	ASI		SPOS		POZ	6
KUL	1 11	MOP		KWEN		PER	
VANG		POIC		NOEM			
DRUT		KNIK		DAL			
TRA		CIL	=	VAGJ			
NEK		BA		EUT			
GAM		BAK		MET			
BES		PANG		HUI			
HONG		PEU		BOU			
QUY		BLO	OV-	KWA			
ORG		GAT		LAM			
PER		TNI		LUN			
TDI		HAA		DIG			
SHIE		TIF		MAL			
CUA		RA		HATH			
SHW		TSO		AMU			
		ALS		KANA			
		WHS		LIFE			
		TEM		DUMM			

Other Examples of Alien Script

In 1989, while working with John Lear, I ran across an interesting case in which an individual (lets call him Gregg) interacted with another race which had as a significant part of its culture the use of mathematical probability functions and high-level computers. This person lived not too far from John, off Sunrise Mountain in Las Vegas.

At a meeting with this man and his wife, he described a situation in which he had made an agreement with this culture to let one of them use his body for ten years "in trade for another ten years of life". This is did, and the individual who occupied his body exhibited very interesting characteristics. He could drive across town and collapse time, making the stop lights change with a wave of his hand. The CIA evidently became aware of Gregg II, and attempted to interact with him; according to Gregg I, Gregg II had absolute power over the CIA people that came to "investigate" him and his activities. To make a long story short, at the end of the ten year period, Gregg I came back into his body to find that he had a new house and a new job. He discovered, after being pulled over for a minor traffic violation, that the police excused themselves for pulling him over. There was evidently something on file in the national computer system which warned officials not to harrass him. As the difference between Gregg I and Gregg II was just the being inside the body, the police never knew the difference. Gregg I discovered that there was a study in the house where Gregg II had lived that contained volumes on medical studies and biochemistry, as well as large power cables that were cut off and that led nowhere. Gregg II had built an female android, which Gregg I eventually met. The android, when viewing a human child, asked Gregg I "what is it's function?". The android wrote Gregg I letters after the departure of the alien consciousness, but he doesn't understand the alien script any more, at least consciously. I had a chance to view one of the letters and copied down some of the script:

M0'0J n0'x 0 d0'k0 70'q 77
x3'001m 0'1m xw'0'x 70'x
x0'0 70'q 0 0m'k 0k0 0'1m 0q
070'ss 70'q k0'0'7 77 7w 0w

Christa Tilton had an acquaintance named Donovan who was also an abductee. During some of his adventures, he noticed the following example of alien script:

70C U7JO 0n 0700

RETICULAN DATA

1. The Reticulans appear to be a highly aware grouping of entities that function as a social memory complex. Individuality appears to exist, but is overshadowed by the group mind.
2. In order to study the unique, individual consciousness of the human species, the Reticulans are domesticating and cloning a number of humans for experimental purposes.
3. The aliens are subjecting some humans to processes which enhance intelligence.
4. The Reticulans are millions of years old as a species and have weakened DNA structure as a result of conflicts which involved nuclear radiation.
5. The Reticulans have relied on artificial reproduction or cloning and face extinction from incurable genetic diseases.
6. They are creating hybrid human-Reticulans capable of mating with humans.
7. Targets of Reticulan Observation:
 - (1) Water supplies
 - (2) Nuclear Arsenals and Test Facilities
 - (3) Military Electronic Surveillance Facilities
 - (4) Military Installations
8. Advanced quantum physics coupled with knowledge on Ontological sciences give the Reticulans advantage over 3rd density civilizations.
9. The true Player in the Game has the capability of covert manipulation of equal or lesser technological races.
10. The Pawns in the game can be implanted and controlled by the Players but cannot be destroyed or vanquished; they can be manipulated into self-destructive modes.
11. The Reticulans are largely involved in scientific exobiological surveys as well as systemic geological observation and field studies.
12. On board some Reticulan craft there are:
 - (1) UV screening devices
 - (2) Tempo/Spacial/Jump Coordinator Circuits
 - (3) Remote Telemetry Scanning with Holographic Recording
 - (4) Multi-density penetrating scanner / Zeta-ray device with holographic display, for viewing inside buildings, underground and underwater.
 - (5) Interdimensional penetration of craft into solid matter.

13. Technological Wizardry of the Network

- (A) Catechomine Beta-Lipotropin 4753, a mixture which is a distillation of slightly enkephalinic melanocyte-stimulating adrenocorticotropic hormone; a cerebral cortex "roto-rooter"; removes certain body blocks and boosts intelligence.
- (B) Inculcation Monitor: a modulated catecholamine encoded laser beam that resonates within the optic nerve network of the subject, setting up harmonic vibrations which disseminate encoding sequences to the proper receptor sites.

14. Learning, Teaching and Assimilation Techniques

In electronic space societies, learning is accomplished by forceful means such as by electronic implant. There are several means of rapid inculcation, depending on whether one uses a Doll Body or a meat-body for identification.

- (A) One dons a helmet which has wires and needles attached to it, and a crystal cube is put into a niche in the top of the helmet. A strobe flashes at the subject's brain wave frequencies and a series of images are impressed into the subject's consciousness. Individuals are trained to perform complex tasks in a short period of time.
- (B) The subject is hypnotized or made to sleep and a high frequency microwave emission is used as a carrier wave on which to send encoded data into the RRS (Ridge Response System). Here, the data can be triggered later by a pre-arranged stimulus-response signal in the environment.
- (C) The subject can sit facing a screen and interact with images on the holographic display.
- (D) The subject is made to lay down on a table and face the inculcation monitor, a bar of flashing colored lights, and is reprogrammed to serve the Confederacy in some new capacity.

15. Objectives of Reticulum:

- (1) Political Objective is Conquest
- (2) Social Objectives are Obedience and Duty
- (3) Religion/Philosophy is Science
- (4) Military Operations: Colonization, establishment of trade terminals and routes, mining operations and the exchange of information.

16. Direct Observance and Inculcation Procedures

- (a) The subject is located
- (b) The Ridge Response System is checked.
- (c) The subject is allowed to view a craft, becomes curious.
- (d) Monitored data is transmitted for decision.
- (e) If found acceptable, subject is directed to an isolated area, picked up, examined, made to forget the experience, and returned back to the planet.
- (f) Sometimes a targeted being will be picked up in childhood and taken to an earth base for crystal implantation and is then monitored throughout the growth period. In young adult stage, the subject is picked up, the crystals are removed and the being is "parked in reserve" for future triggering and employment.

17. Damage to Network Craft: Radar beams can interfere with both programs and propulsion.

18. The Reticulans are from a civilization which appears to be totally dedicated to interstellar research and life analysis.

19. The Network has been on Earth for the past 50 years.

20. Past contacts with Earth governments have been rejected. Eisenhower.

Discussion of Density Levels and the Greys

The Greys are led by non-corporeal beings of sixth density, of which there are only a very few. A sixth density being is at a non-physical level where the being exists as the entire dimension itself. A sixth density being would be aware of the many dimensions he is while still being separated to some degree from his many selves or projected consciousnesses.

Fifth density beings are non-corporeal in nature and also experience themselves as the entire dimension. There are large numbers of fourth and fifth density Greys involved in the situation here on Earth. Fifth density is the last density above humans (third density) that can retain negativity. At this level you will find the true player in the game. They are powerful intelligent beings who are capable of interdimensional travel.

Fifth density beings have the ability to control an entire sector of space.

Fourth density beings exist on the level of race consciousness, and are in touch with their own sixth density consciousness. They can draw energy and knowledge from their other components. The fourth density entity is in the unique position of being able to transit between third and fourth densities, and are largely parapsychical when viewed from a third density perspective. These beings make use of both organic bodies and synthetic androids. These beings appear energetic and aware, but emotionally cold, to the human. They are, in fact, extremely curious about all aspects of existence, highly analytical and devoid of any sentimentality. They can experience emotions from humans in a high-energy state (terror, fear, etc) and in doing so gain sort of an elevation of mood. Fourth density Greys, the ones who are primarily dealing with Whitley Streiber, are the ones who possess the technical equipment to draw energy from the human bio-plasmic field. They also have the ability to extract memories and experiences from the human being. It is they who await in the light when a human being dies. The human being is then recycled into another body and the process begins all over again. Fourth density Greys are, in effect, sensation junkies. To experience human emotions and feelings is the closest they themselves ever come to the idea of feeling.

The Greys were ultimately behind the Thule Group in Germany during the war, and no doubt were ultimately behind the German policy of internment and termination of the Jews during the war. Think of the emotion that was generated in the concentration camps!

Reptilian - Grey Data

by

Jason Bishop III

THE PASTURING AND USE OF SURFACE EARTH HUMANS

Most "UFO buffs" think that their efforts will lead to some sensible attention by the "Authorities" to the broad problem the UFOs present...the problem of 'are they Invaders?', 'what do they want here on Earth?', and all those other nagging questions. They come to Earth for things surface people don't even know about.

Earth is on the ancient space trade routes. They come to bases (Cavern City Complexes) and they mine, manufacture, and do some genetic manipulations to form various subservient cross breeds.

The Reptilians

For the most part, we are dealing with another species that is humanoid in shape, but Reptilian in heritage. Their leader elite are the "Draco". They even have special "wings", which are flaps of skin, supported by long ribs. These can be folded back against the body. They are also known as the "Dragon Race" and their symbology usually includes the Winged Serpent. There are elements of their species which do not have wings - the "soldier class" and "scientists" have none.

They are all 'cold blooded' and have to have a balanced environment to maintain body temperature. The "soldier class" of the species can bury themselves in the ground and wait long periods of time in order to ambush their enemy. If need be they can survive on one very large meal every few weeks or even once a year.

As a species, they are well suited for space travel due to their ability to hibernate. These reptoids have scales which protect them from moisture loss. They have no sweat glands.

The scales (scutes) are much larger on their backs, making the skin waterproof. The scales elsewhere on the body are more flexible. They have three fingers with an opposing thumb. The eyes are catlike and large. They have twin nostrils at the end of a short stubby muzzle. They are mostly meateaters.

The mouth is more like a slit, but they have teeth which are differentiated into incisors, canines, and molars. They average from 6 to 7 feet in height.

REPTILIAN GENETIC CONFIGURATIONS

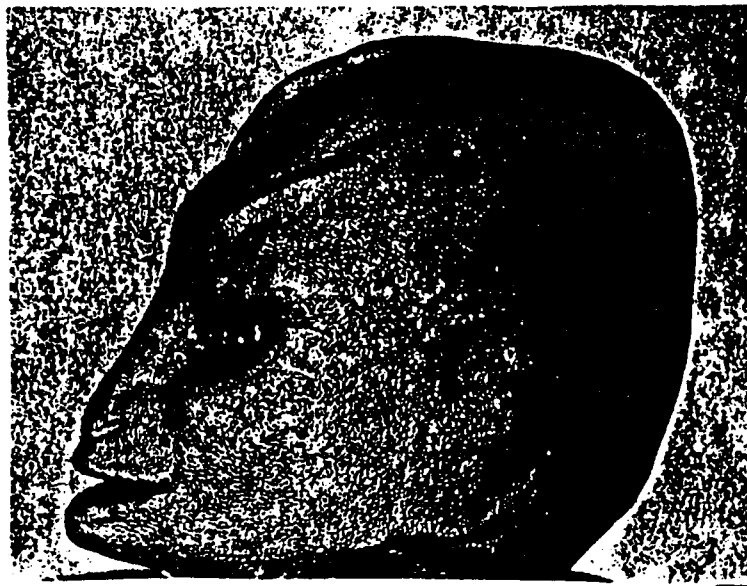

The photographs above depict reptilian visual configurations that have been deemed accurate by one individual who has had contact with them.

Reptilian - Grey Data

The Reptilian (amphibian) humanoids have been interacting with Earth for ages. Many contactees and abductees repeatedly describe an insignia of a Flying Serpent on a shoulder patch, a badge, a medallion or a helmet. The Serpent Race lives under the ground.

The Greys

The Reptilian species directs the efforts of the worker class, which are about 4 feet tall. These are currently referred to as Greys or EBEs, and are the largest category likely to be encountered by surface humans. The Greys are really an order of crossbreed between Humans and Reptilian species. There are several other lines of crossbreeds which have been bred for various specific characteristics. Some hybrids have an active pineal eye and are telepathic.

These beings (the Greys) operate very efficiently in the dark. Their eyes are more sensitive to ultraviolet light. They have the ability to control their heart rate. The normal heart rate for a Grey is above that of a human. The skin seems to have a metallic content and an unusual cobalt pigmentation. Many have no external sex organs. Some have been bred to have them.

There are accounts in the legends of Babylon, India, Egypt, South America, Central America and elsewhere that reveal the influence of this other species on our own.

One variety of Reptilian crossbreed is particularly negative and dangerous. This variety, who work with the Draco, originate from a system having much more high energy radiation than on the Earth. These "detrimental beings" do not "eat" in the same way humans do. These hive-like beings use synthetically produced substances, mixed with blood. This slurry is sometimes mixed with Hydrogen Peroxide, which kills the foreign bacteria and viruses. They may also be feeding off the "life essence energy" of the substances. They also seem to "feed" off nuclear energy, and have manipulated humans into developing sources of nuclear power that emit radiation. Nuclear methods involved use neutrons and create radiation. Methods that use positrons emit no radiation.

The "Greys" (the short, "Big Heads") are mercenaries. They interface with humans in "Secret Societies" and within the Military/Governmental Complex. An interconnected "WEB" manipulates the surface Earth cultures.

Command Progression

DRACO (Winged Reptilian) -> DRACO (Non-Winged) -> Greys -> Humans

Reptilian - Grey Data

Other Species

It should be noted that not all the cross-breeds are hostile and steeped in elitism. There are beings that are thought to be the descendents of an ancient "Elder Race". Most of these beings have blond hair, large forehead, and medium dark or light complexion. Those who have dark hair are also shorter in height.

Conflict for Control

A covert species war is currently being fought between the Draconian linked cultures and the Orion linked cultures. The truce as applied to Earth is under extreme stress.

The so-called Orion Group is an Empire. Their purpose is conquest then enslavement of the un-elite. These "crusaders" set up bases within Maldek (now destroyed), Mars and Earth.

The Draconian Group is a Confederation. They are the Reptilian Humanoids, with subgroups (The "Serpent Race" from Sirius) and various crossbreeds. They set up bases inside of Venus, the Earth, and other locations. Earth is on their trade route.

Certain contactees have been manipulated by both groups. This has created confusion and was done to discredit these individuals. With this mix of influences and distortions it is no wonder that Earth humans are ripe for enslavement.

The "Harvest" will occur during a period of time to come. The conflict presently underway is for control of the Earth and those here. Humans are "related" to both major extra-terrestrial forces. Both groups are using and crossbreeding with humans.

Historical Background

There is one race referred to as the ELs or Elders that have conducted experiments on Earth that have involved both artificial insemination and interbreeding with HU (animal)-Men beings. They created a genetic "under-species" - HuMen.- to do mining and other work. Eventually, the Serpent Race stimulated the ELs "hypno-slaves" into Self-Awareness. This act caused the Hu-Men under-species to be turned out on its own. The Serpent Race was forced by the ELs deep underground as well as off the planet. The conflict continues to this day. A large portion of present day humanity is descended from mixed gene ancestry. The ELs and the Reptilians have both continued to cross breed with Humans. They need humans, and conspire together to keep humans ignorant and under control. Humans must recognize the "control web" and go beyond it.

Reptilian - Grey Data

Inner Earth Species
called Sasquatch

In April of 1974, psychic Joyce Partise of southern California held a sealed envelope in her hands. Unknown to her, that envelope held a photograph of a Sasquatch footprint taken in a heavily wooded area in the northern part of the state.

Her initial remarks:

"This envelope is like a death certificate! I foresee an impending disaster, yes, now I see what it is. These things are coming from outer space - it's an outer space war! The first area will be Portland, Oregon. There's a mountain with a hole in it. Somebody should investigate this mountain because they're down there already. You know those hairy things that run around, the ape man? He's not an ape. They're underground, in contact with outer space and their intentions toward mankind is total destruction".

Exerpts from the rest of the reading:

"This gorilla man - there's a civilization of thousands of them - he looks creepy but he's intelligent. Their eyes are extremely sensitive from being underground. It's though they're from another civilization long ago and have mutated because of radiation. This has altered their brains and now they're able to communicate with those in outer space. The sad thing is that these aliens are using them for their work, for laborers, but I can't tell what they're building. These aliens are desperate. Something is happening to their planet and they are preparing themselves for the time when they must leave. They must have a place to go, and right now they are analyzing out planet with the help of those hairy creatures and want to take it over."

Note: Take a look at the drawings of the Reptilian Humanoids on page 89 and imagine them with hair instead of scales. It is clear that there are genetic similarities.

Reptilian - Grey Data

Underground Bases and Way Stations

In Robertson County (Texas) UFOs have become a nightly occurrence. Other factors which occur in the same location:

1. Unexplained tracks on the ground.
2. Mysterious deaths and disappearances of livestock.
3. Interference with normal radio reception.
4. Strange code being received on CB radio frequencies.
5. Power blackouts.

The caverns beneath Calvert, Texas are being used for some type of operations. Farmers and ranchers in the area have reported hearing peculiar noises coming from deep beneath their feet.

"Individuals living 5 or 6 miles outside Calvert have been repeatedly driven out of their homes by the sound of generators".

In April 1973, students camping in the San Gabriel Mountains on the western edge of the Mohave desert "felt uneasy" and then saw a giant man-like creature. Researchers from the UFO Research Institute were called in. They discovered the sound of geared machinery and what might be compared to a hydroelectric plant coming from 'beneath the forest floor'. Sounds of operating machinery have been recorded coming from mines in the area after midnight.

The Yakima Indian Reservation

Southeast of Tacoma, Washington is the Yakima Indian Reservation. Of special interest is one particular section 40 miles wide and 70 miles long, bordered on the west by the Cascade Mountain Range. It is an area of canyons and heavily forested regions. The valley is essentially closed to the public and special permits are required to enter. Forestry personnel have heard (Dorthea Sturm) unusual sounds for years coming from underground. One area of intense activity is known as Toppenish Ridge. From deep within the dark, restricted canyons, "glows" have been seen. This area is not accessible by foot or vehicle. Low-flying silver cigar-shaped craft have been seen to disappear into the deep canyon known as the Middle Fork of Toppenish Creek.

Additional Information about the Greys and Reptilian Species and their General Activities with Human Beings on Earth

The general class of beings known as the Greys make up several species. All the species seem to have rigidly defined social classes, which tends to be a hallmark of electronic space societies. In general, there are three kinds of Greys: The Reticulans, who are about 4.5 feet tall, those from Belletrax (also in the Orion system) that are about 3.5 feet tall, and another species of Orion Grey that ranges in height from 6 to 9 feet tall.

In general, the Greys that have operated on Earth for a long time are subservient to a large Reptilian species. Because of their subservience to the Reptilian species, it is possible that they would, in principle, desire the aid of humans in any future confrontation with their Reptilian masters. This could be the main reason behind the training that is given to abductees. The planetoid that is entering our solar system at this time (it will be here in the coming years) has been written up in several major newspapers, and it has been determined that it is being intelligently guided and that it emanates a large variety of frequencies within the electromagnetic spectrum (which indicates that it is occupied and has a technical culture).

The Zeta Reticulans appear to be divided into two social classes, one being more hawkish than the other. The more peaceful of the two appears more refined and has demonstrated a more tolerant attitude toward humans. The other class is more abrupt, blunt and crude toward humans.

Through analysis of many cases, it would appear that the tall Greys have one base near the Aleutian Islands. The taller Greys seem to have overall influence over the Reticulans and also over the Belletrax species. The influence over humans seems to center around implantation of human political figures and those in control of planetary power groups.

The Zetas have apparently reproduced themselves for thousands of years by the cloning method. They have devolved from the sexual reproduction process so that all sexual organs (as well as their digestive tract) have totally atrophied. They have no stomach and digest their "food" by absorption through the skin or under the tongue. The mouth cavity is approximately two to three inches in depth.

These are the entities that are involved (the government is also involved) in cattle mutilations. They absorb specific substances from the cattle products that seem to lend stability during the cloning process. These substances originate in certain glands and mucus membranes (lips, nose, genitals, and rectum). The problem that these entities have come to experience is that in the re-cloning process each copy is genetically weaker than the last. This has stimulated their interest in the creation of a hybrid through genetic

engineering with human genes, trying to merge and blend the species in order to preserve their race. It is for this reason that the Zetas abduct humans (other species have similar reasons for abducting humans). Many of the abductions have an outwardly "cruel" nature to them, insofar as the nature of the examinations and genetic work is quite psychologically disturbing to humans. For example, a caged vacuum tube is often inserted up the human rectum and around into the intestines in order to withdraw samples of fecal material for analysis, apparently to examine the types of food eaten as well as the results of the digestive process relative to alien influence on the physical body.

The Blue Ray

Several types of beams are used by the aliens. One in particular, the blue colored ray, is used for paralyzing, capturing, and transporting humans. The action of being beamed into a ship temporarily suffocates the human, as all the oxygen is suddenly removed from all the cells of the body during the process. Another type of radiation restores the oxygen to the body upon arrival. When the aliens themselves use beam transport, a different type of beam is used that permits them to arrive completely alert. The blue beam is described quite frequently by abductees.

Nutrition

You will recall that "mutilations" generally result in all of the blood being withdrawn from the body. This has been the case whether the subject is an "animal" or a human. The blood and other fluids are then generally transferred to holding containers, or vats, as well as other body parts. There are many many reports of humans in various situations and scenarios having come in contact with aliens, or have been in caves or caverns with aliens, and having seen canisters or vats in which animal parts were floating, and in which a purple-red fluid was present as a substance in which to suspend all the materials.

There was one case where a woman and her two children were abducted by the entities from Belletrax (the entities referred to as "SM's" in the Case For the UFO) and she would not cooperate with them when they had her on board their ship. Their reply to this lack of cooperation was very direct - they killed both of her children. She managed to run down a hallway and went into a room where she saw a vat full of red liquid and body parts of humans and animals. She saw another vat of the same type in which the liquid was being agitated, and as she looked into the vat she could see Greys bobbing up and down, almost swimming, absorbing the nutrients through their skin. There is also the use of H_2O_2 in the vats in order to aid in preserving the fluid from rapid

degeneration. These entities have been abducting humans for many centuries - these entities view Earth as a big farm, and have been essentially raising and harvesting humans and apparently abduct humans to take them back to their home planet to raise there in a kind of human husbandry scenario.



Child Sacrifice in the Christian Bible

If you study ancient history, you will find that it was common, especially in the time of Bael, for humans to sacrifice their children to their "gods". The process still takes place, especially in some Satanic rituals, today. The reason why these practices occurred is that the children were being given to alien races. The ancient "gods" of the Old Testament were beings of a radically different nature than the human species. These were the same entities that destroyed the cities of Sodom and Gomorrah, because they did not like their own people mingling with humans and decided that humans were too much of a nuisance. The stories given in the Old Testament relate to other

archaeological studies found in other cultures. Babylonian, Akkadian, Sumerian, Ur and Egyptian cultures all carry stories that add to and clarify the stories in the Old Testament. These stories, as pointed out later on in this book, indicate that the entities who were portrayed as "gods" were in fact space aliens. Usually these "gods" asked for sacrifices of a human nature. Here we are referring back to the period over 12,000 years ago, but the practice has been continued.

There are indications that the ritual of the Eucharist (eating bread to symbolize the body) is a reflection of earlier rituals where aliens were eating off the bodies of humans or feeding off their energies. The phases "Food of the Gods" takes on new meaning when these factors are understood. The true "Nectar of the Gods" which the aliens involved seem to prize most is a substance that is taken from freshly killed humans. This substance is generated at the moment of death by the strong surge of adrenaline. This surge of adrenaline through the body accumulates at the base of the brain (the brain stem) and some aliens thrive on this substance as though it were some kind of ultimate drug for their particular species. This substance is most potent in human children.

Past Influences of the Reptilians

The Reptilian species that are soon coming back to Earth are the same entities who affected much of Earth's history in the past. It was the Reptilian types that were represented in the Garden of Eden story as the serpent. The entities that originally participated in the creation of the Homo Sapiens species placed the entities (humans) that they had genetically engineered in their own image in the area of what is presently Lebanon and Syria after their "expulsion" from the "Garden of Eden", which some research seems to indicate was a laboratory complex on Mars run by a group of entities known as the Jehovah, who seemed to be regarded by the Pleiadian humans as space renegades. The process of development of the Homo Sapiens species was interfered with at a later time (see the overthrow of Ea on page 374A).

Other types of Reptilian Species

In the Draco system there are other types of entities which have visited the Earth in the past. These entities were described by John Keel in his book *The Mothman Prophecies*, released in the 1970's. The Draco are about 8 feet tall and have winged appendages coming out of their shoulders, dark scaly skin, and have glowing red eyes. They have the ability to fly and usually operate at night. These entities, as well as the elite of the other Reptilian species (that also have winged appendages) were the source for some of the legends of the past relating to gargoyles and Valkyries. It is also apparent that some of the qualities ascribed to vampires have also been taken from these creatures.



(c) Chan Johnson 1988

Entities from Alcyone System

These entities were encountered by a woman in California in the 1980's. Their skin was dark green in color. They wore a pad on their arm that they used to wipe excretia from a hole in the back of their neck. These entities function mostly in 4th and 5th densities, which includes the densities humans refer to as "astral". The woman was told that she was abducted and implanted because they thought she was an "opinion leader". The beings would develop a pulsing glow around their heads when they became excited. The entities function according to Service to Self and utilize implantation as a manipulative factor.

T'was Brillig.....

Alien Species (Service to Self)

1. Some of the various 22 sub-species of Greys originally started out as tall blond-haired humanoids in the Lyrae system, but were subject to heavy radiation due to a nuclear exchange over a long period of time, changing their DNA to the point where some of the species became stunted misshapen dwarves. Glandular structures were also affected, including reproductive and digestive organs.
2. The nuclear exchange occurred approximately 10,450 years ago.
3. Digestive tract is useless. Nourishment is ingested by smearing a soupy mixture of biologicals on the epidermis.
4. Food Source: Bovine cattle parts (and human) surgically removed by light technology (laser) and distilled into a high protein broth.
5. These type of Greys have been referred to as being the "Orion Crusaders" or the "Markabians" . Sources: Rigel, Ursa Major, Draconis, Reticulum. Draconians are Reptilian in nature; the elite have winged appendages on their backs.
6. The race is interacting with portions of the US Government.
7. The mass consciousness of the government agencies cooperating with the Rigellians have failed to realize that it is not to the aliens advantage to give either the Soviets or the US an advantage in the "arms race". These aliens have given the US technology that is flawed. Much of the technology can only be operated by the Greys.
8. They control governments by picking up likely subjects and implanting them, manipulating their careers and elevating them within the societal structure to positions of power and/or a position as a leader of public opinion. When a human candidate becomes controlled by reason of inculcation therapy, they often knock the individual "out of his head" and store the humans consciousness/individuality while an artificially created intelligence is placed in the head of the candidates body to carry forth covert operations against the human population.
9. Humans implanted as controls are indoctrinated into the belief that they are superior to other humans. The aliens then give the humans technology or help them to obtain weapons for use against each other. All key personnel are implanted and controlled by the alien species.
10. If the "elite" are successful, they are used as "priests and

caretakers" of the slave planet. If they fail (Hitler) then they are betrayed and thrown to the wolves.

11. Attitude toward humans is "tolerance towards inferiors".
12. Any consideration of these specific entities permitting an atomic war on Earth is counterproductive. It would destroy their food supply.
13. These aliens have technological superiority but appear to lack in spiritual and social sciences. This is evident in their obvious lack of warmth, emotionality, and respect relative to humans.
14. The first stage of their One World plan is to use biological warfare to rid the planet of undesirables. The biological warfare is out of control. Decimation of population places the remaining population ultimately under their control.
15. They can sometimes obtain momentary pleasure in terms of mood elevation by tuning in on human wavelengths via telepathically connected radionic devices. They react to intense human emotion such as ecstasy or agony. "UFOS" in war zones. Nazi vs Jew.
16. They blanket couples for sexual thrills and are drawn to abberants and sexual deviates.
17. The biological as well as the psychological processes of human emotion and reaction are translated via scalar electromagnetics and directed towards their center of conscious focus in order to elevate mood.
18. The Markabs use sex, pain, drugs and fear as obsessive elements with which to abberate humans.
19. In order for humans to extricate themselves from the covert sinister alliance between the CIA and Rigel, which has occurred without the knowledge and consent of the mass consciousness, the people must regain control of the government (which is a govt for the people and by the people).
20. Tyrants have been defeated many times in this galaxy and others. Whenever one tyrant of one group or species is banished or defeated forever, another suppressive group or species arrives to take their place. What one resists one becomes.
21. One can never gain control over anyone but oneself.
22. Lower 4th density is always subject to tyranny.
23. By coming to a thorough understanding of a hostile entities ability to wear many faces, it unmask and loses its ability to adversely influence.

(Service to Others)

1. There is a species from Procyon that has had a hand in the genetic development of humans and were involved with the initial interbreeding with primitive humans. Thus the sudden emergence of Cro Magnon human.
2. Procyonian basic purpose: The Law of One is service to others. They feel that All That Is will benefit if man can develop as a true social memory complex, i.e., an aligned mass consciousness or integrated biospheric entity. To them, 5 billion beings integrated as One "Awareness of Awareness" Unit in Creation is a natural State. Each separate entity still maintains the individual unique nature, which is the sum total of its integrated experiences, its basic differentiated identity as a spiritual entity aware of its immortality despite the use of an organic genetic entity (body).
3. Their aim is to help us to help ourselves by bringing humans to their full potential.
4. Failing goal #3 above, they will reap the smaller harvest of human souls and relocate them for advanced schooling elsewhere (or "elsewhen" in the event of a natural disaster).
5. Humans tend to make Savior or Satan figures out of extraterrestrial or extradensity beings. In doing so, they hope to negate responsibility for their misdeeds by appointing scapegoats. It is a self defeating strategy. Awaiting a "savior from the skies" is a recipe for disaster. If individuals do their best and work toward peace and unity of purpose, it will contribute towards correction of the imbalance. There are no guarantees.
6. "Christ-Consciousness" (4th density) is awe-inspiring to humans of the 3rd density. It is far more demanding to develop the full spectrum of awareness. It is up to individuals to create their destiny.
7. The Procyonians have the ability to travel within timeframes and density levels, as well as inbetween. Rigelian entities lack this capability. They depend on beam craft for interstellar travel. Procyonians "astrally" travel from location to location (perception to perception) as a natural function.
8. The Procyonian craft are constructed in one piece that is fabricated within an energy Matrix and solidified as an aware living crystal that is perfectly tuned to the pilot via computer link. The craft itself has a limited awareness level, as would a thoughtform entity or mock-up.

9. When the beamship contains three or more crew members who are the same density as the craft, then a teleportation sequence is possible.
10. The name of the home planet of the Procyonians translates roughly as "those who travel through time".
11. All cultures go through states of higher technological development prior to learning that everything they have accomplished can be achieved by way of pure thought.
12. Humanity as a mass consciousness can create any destiny it chooses to create for itself.

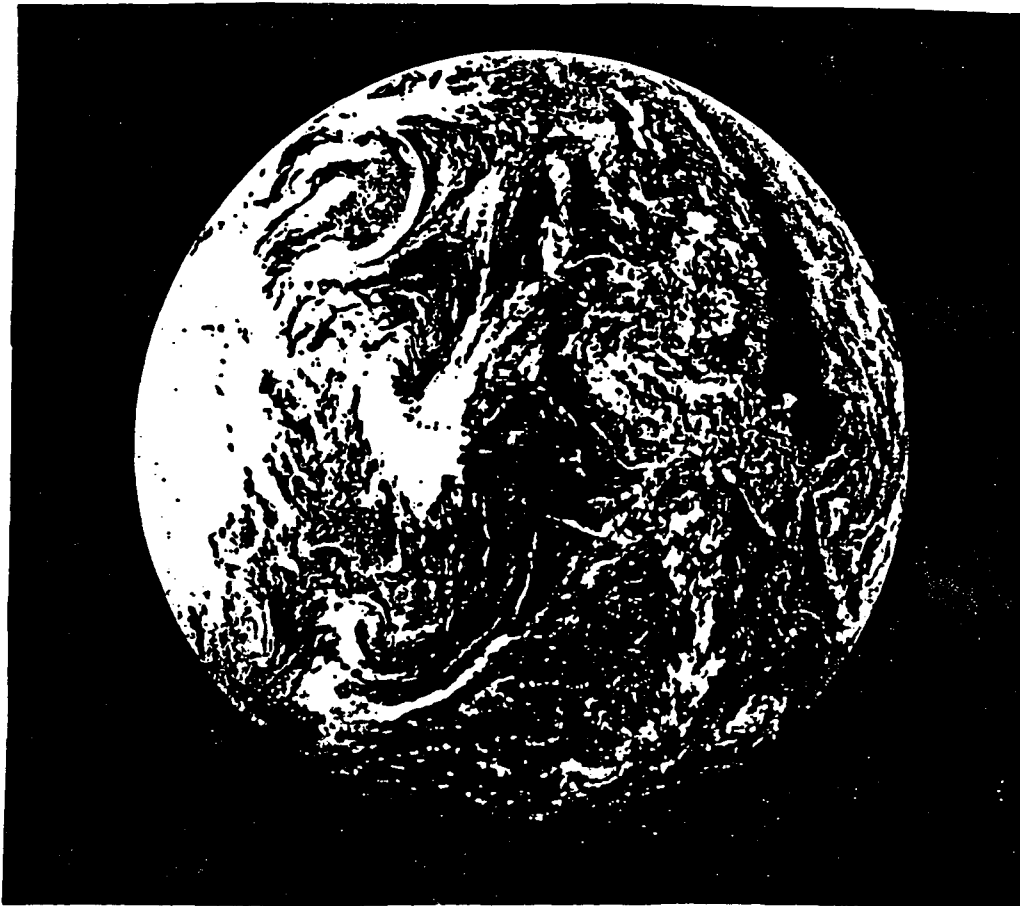

The Bennewitz Studies
of Alien Cultures

Nowhere do the observations of Paul Bennewitz come more into view than in his March 1986 letter to Clifford Stone, now director of UFO Contact Center International in Albuquerque. Paul Bennewitz, a scientist who owns Thunder Scientific Company in Albuquerque, made the discovery very early on that alien craft were frequenting Manzano Weapons storage area. Bennewitz investigated what was apparently happening there, compiled documentation, and made the critical error of contacting the Government about it. From then on he was subject to investigation and manipulation. Bennewitz found a way to communicate with some of the alien species via special equipment which resulted in communication through his computer, much like the situation with a modem. Bennewitz extracted a lot of information about the different groups of aliens, several of which were either related genetically to the Greys or were working with them. Bennewitz discovered several cultures that were highly stratified in nature and different in structure. For sake of simplicity, he refers to them as Very High culture, High Culture, and Low Culture. Bennewitz wrote this letter after seven years of contact had occurred. What follows is extracted from that letter. Comments are in brackets(): (Courtesy CRUX)

"Dear Clifford,

"I received your last package containing the Socorro Insignia and the transcript of the meeting held here in 1983 with Richard Doty. Most appreciate it.

"First- as we are becoming acquainted I would like to indicate a few things. These individuals that met with Doty are, in my book, precise examples of the pseudo-scientific dogma that haunts this entire business. They apparently got an enormous kick out of make believe cloak and dagger, worrying about telling an OSI agent that they don't have a tape recorder, etc. You can bet that Doty, to protect himself at a later date, was wired for sound. I know him too well.

"I am forever amazed at individuals such as these that think they can walk in and talk with one such as Rick and that he would bare his soul- "talking to them as a civilian" and telling them everything. It just does not happen that way.

"And also alas I am forever at a loss to explain why - invariably all of them will never give credit where credit is due in areas where they are not experienced - nor have the credentials - such as the Computer Thought Communications Link. Rather, as shown in that transcript they are directly critical, yet none even bothered to ask directed questions nor ever came to look at it or evaluate it scientifically.

"They have never thought deeply and analytically enough to realize communication with Alien Lifeforms is not cut and dried. One must build upon this type of research-expanding in a route to fully understand Alien psychology - what their culture is - how it expresses itself - its emotions - its level of thinking.

"Contrary to the apparent Ego orientation of B.M. and the other so-called "experts" - the Alien will not meet their projected response criteria when their complete analysis and way of looking at the Alien is based upon a narrow standard of reference - the Human-Homo Sapien.

"To be honest about it, the Alien cultures look upon them as a bunch of half-scientific, unmitigated, narrow-minded, ego-oriented asses. That is exactly what is and has defeated their efforts to even begin to understand this and, in particular, how to find out and know not only the logic involved by what it portends for the future without the input of the Government, its agents, etc.

"There is so much in this and so much has happened upon a near daily basis to me for seven years that I don't know where to start first.

"I think probably the best approach is to start out with some explanation in the way of statements relative to alien cultures here on Earth, their social structures, physical makeup, etc., all of which has been gleaned from the direct communications by computer, visual observation, psychological evaluation, and personal interaction.

"First, there are Low, High and Very High cultural levels. In the Low levels of the culture there are sharply defined levels, which extend from slave level on up. There is no freedom there - no one crosses these lines within - cross it and you are dead. Everything is watched with optical equipment and monitored by computers and individuals called "Keepers".

"Spheres of many sizes float throughout their environment, monitoring audio, visual and thought frequencies. These units, which have a highly mirrored finish, can be talked to. They can cloak themselves so that they are totally invisible. Their control signal can be broken down into varying AM and FM components. There is no trust in this type of society. Everything is watched and monitored.

"The command structure is near totally unbelievable.

"The ruling levels wear robes of appropriate colors. The alien government involved with this group is totalitarian. They appear not to observe and social or moral principles. Their credo appears to be total control or kill.

The Culture of the Low Levels

"In the North - at the river - the Orange Insignia - or at the Diamond as the alien calls the base. The method of rule is a monarchy. The "king" wears purple. The high colors of social level were green, yellow, and white. The lower levels wore brown.

"Their body metabolism is very high, estimated at 110 to 115 degrees. Elimination is through osmosis. Skin color of the ruling echelon varies from a jaundiced yellow to white. No hair of any kind. The arms are long - near to knee level. They have very long hands and fingers. All of them look underfed. They have big heads and eyes. The humanoid types are generally light green. When in need of formula or dead they turn GREY. Many in this culture walk with a limp or shuffle their feet.

"Insignia employed on ships and uniforms:
Colors are predomiently Orange on a
greenish-blue background.



"There is a council in the North called the Nine. All of them seem to be cut from the same pattern. All appear to be highly vindictive and ego-oriented. Their "God" is called "TA".

3/19/86

"It would appear they the Greys in the north are near frantic about my communications and want to stop me from talking with Io via the computer.

"This morning I have a dark red streak down the left side of my face about 2 3/4 inches long and 1/4 inch wide. Based on experience, I would guess it was done by one of those (mirrored) spheres in the bedroom last night. This is typical of their distorted sense of logic. They operate on fear, but their problem is that I don't fear them. All they have achieved with me is that I totally ignore them. It would appear that they are deathly afraid of the beings called Io and Jo (see High Culture).

"You will find, if you have not already, that constant interaction will result in learnming how to be aware of, and in turn use, alien logic. It allows you to read the real intent behind what they say and do. *It is because they operate in fear and do not understand the concepts of friendship and trust that they operate a society where everyone and everything is watched.*

"Now, if you look at those in the north pragmatically, they have achieved the ideal in terms of war machines and weapons. With their machines and weapons they are "brave" - in their minds - without them they are just a quivering mass of fear.

"To further enhance their "bravery", they seek full control with the *implant*. (The relative effectiveness of the some of these implants seems to be inversely proportional to expanded memory and awareness level). They also know that they can control large masses of people with lower intelligence without implants - shotgun manipulation with the beams. With that beam they can and do create mass unrest.

The High Culture Aliens known as the Eoku

"The High is apparently the culture of Io and Jo. They do exhibit kindness, empathy, and extreme intelligence in transmissions through the computer. Io's group culture is of the Homo Sapiens Variety.

"Based upon the input from Jo, his hair is brown and the female Io has red hair. (Red-haired individuals claiming to be Star Travelers have shown up here in Albuquerque on the ground). They did give indication that bodies of their group are here in Albuquerque in cryogenic containers. The location is tentatively the FAA complex north in Albuquerque. It is a fenced and guarded highly secure area. They indicated through the computer that 8 of the Eoku were shot (by the US Government) and 11 bodies were the result of crashes. (Note: the Eoku are not what are normally known as Greys, or at least the ones that directly interact in human abductions).

"There are more bodies in storage that . I don't know where they all are. I knew the bodies had been moved from Maryland and are presently under US Navy jurisdiction. Yesterday, the computer indicated a total of 40 bodies (had been moved)

Editor Note:

(At last count there were more than 135 bodies in Government hands) of various descriptions. Some humans, Greys, Reptilians, etc.

"I was shown a color photograph by Richard Doty two years or more ago of a purported alien lifeform held prisoner. Supposedly it was taken at Los Alamos. He was alive - a light green color - big eyes - standing directly in front of the camera. If he was from Io's group he would have been Eoku.

"So far I know very little about the High except for what I have experienced. They are Homo Sapien, and I would guess that they are the same that accidentally zapped Travis Walton. If the numbers are correct out of the computer they number over 5,000. The other group

is, I believe, equivalent in number. Indications seem to be that they are operating from a star ship in far orbit around the Earth.

"The culture has apparent social values and emotionalism. They seem to display kindness and concern for individuals. Their technology is superior to ours and also to the Greys based in the north, who are trying to "play God" with badly distorted logic.

"The "Very High" are very few in number. Their entire structure of knowledge and social interaction is so far advanced that it is near impossible for me to relate to. They are of such an advanced state that if you confronted one with a weapon they would let you shoot them rather than harm you. Again, much of this is based on personal experience of which I have never talked with anyone about. In fact, you are the first.

"I would guess that these "very high" are quite old - 1000 years is not apparently unrealistic. I would guess that there are a few of them on the star ship used by the "high", and that they are preserved and cared for by those on the ship.

"What is happening is that the Eoku and the Greys are flying missions for them. I would guess that they function, in a sense, as the "eyes " of the higher culture.

"Now, let's expand further. Billions of years ago what are now the "very high" reached a level where they understood how to create and modify life forms to the extent where they create human or near human forms. They created the cloned species known as the Greys. The Greys were created as vegetarians and were given high metabolisms to offset heat loss. They (apparently) then created humans and included emotionality and physical characteristics appropriate for Earth.

(Recall that the Government has stated that "the Greys" claim to have created the human matrix. If the above is true, then it is actually the controllers of the Greys who created it)

"For over 300 years, a conflict has been going on between the Greys, who are basically warlike and aggressive, and the higher factions in the infrastructure."

(Editor Note: Bennowitz does not mention interactions between any of these cultures and the Reptilian humanoids, who are known to be enemies of the Greys. It seems that the Reptilian humanoids, who are allegedly on their way here into our system, will perhaps "cross the line" with the "very high" whenever and however they interact with humans. The Reptilian humanoids have not been here en masse for a long time. They are reportedly very regimented and consider humans a sub-species usable for slavery and as a food source. The Reptilian humanoid Elite allegedly have winged appendages on their backs and are apparently resented by the lower class of the species, many of which remained here when the main body left)

P R O J E C T B E T A

SUMMARY & REPORT OF STATUS

[WITH SUGGESTED GUIDELINES]

PROJECT BETA

Investigator - Physicist - Paul F Bennewitz

The following are key mile posts established or discovered during the continuing scientific study concerning Alien intervention and the result. (Study limited solely to New Mexico)

- 1) Two years continuous recorded electronic surveillance and tracking with D.F. 24 hr/day data of alien ships within a sixty (60) mile radius of Albuquerque plus 6000 feet motion picture of same - daylight and night.
- 2) Detection and disassembly of alien communication and video channels - both local, earth, and near space.
- 3) Constant reception of video from alien ship and underground base viewscreen; Typical alien, humanoid and at times apparent Homo Sapiens.
- 4) A case history of an Encounter Victim in New Mexico which lead to the communications link and discovery that apparently all encounter victims have deliberate alien implants along with obvious accompanying scars. The victim's implants were verified by x-ray and Cat Scan. Five other scar cases were verified.
- 5) Established constant direct communications with the Alien using a computer and a form of Hex Decimal Code with Graphics and print-out. This communication was instigated apparently after the US base was vacated.
- 6) Through the alien communication loop, the true underground base location was divulged by the alien and precisely pin-pointed.
- 7) Subsequent aerial and ground photographs revealed landing pylons, ships on the ground - entrances, beam weapons and apparent launch ports - along with aliens on the ground in electrostaticly supported vehicles; charging beam weapons also apparently electrostatic.

- 8) Cross correlation and matching by triangulation, etc., to official NASA CIR (color infrared) high resolution films confirmed base locations and resulted in revealing US Military involvement yielding precise coordinates and the US base layout.
- 9) Prior alien communication had indicated military involvement and the fact the USAF had a ship but due to studied alien psychology this was ignored at the time.
- 10) Subsequently, the alien communicated following verification with the CIR, that there was indeed a ship; actually more than one - that two were wrecked and left behind and another built - this ship is atomic powered and flying. The alien indicated its basing location.
- 11) It was learned as stated that two women and a boy near Austin, Texas were exposed to severe radiation at close range and the ship was last seen going West with helicopters. In addition, the US Government was quietly picking up the expenses.
- 12) Subsequent inspection of motion picture photographs taken during the study revealed the US ship or one like it flying with the aliens. These match the CIR where two can be seen on the ground and in the later photographs taken on the ground after the base was abandoned.

So in very brief form the prologue to learning within reasonable accuracy what transpired prior to the end of 1979 or shortly thereafter.

The computer communications and constant interaction with the alien in this manner without direct encounter has given a reasonably clear picture of the alien psychology, their logic and logic methods and their prime intent.

It is important to note at the outset, the alien is devious, employs deception, has no intent of any apparent peace making process and obviously does not adhere to any prior arranged agreement.

In truth they tend to lie, however their memory for lying is not long and direct comparative computer printout analysis reveals this fact. Therefore much "drops through the crack" so to speak; and from this comes the apparent truth.

It is not the intent of this report to criticize or point fingers. Obviously whoever made the initial agreement was operating upon our basis of logic and not that of the alien and in so doing apparently walked innocently, in time, into a trap.

The alien indicated that the "Greys", apparently the group initially involved in the agreement were still upset about the initial capture and subsequent death of the first eight of their co-fellows.

Another group, calling themselves in the Computer language, the "Orange" - their base is on the west slope of Mt. Archwleta - directly west of the south end of the US base and near NW of the apparent main landing area they call, in the Computer language, "The Diamond". This, because from a distance, it looks diamond shaped in the photographs when looking somewhat south west past the observation tower toward the ridged peak SE of Mt. Archwleta. This ridged peak has no name, I call it South Peak.

The base extends north of this peak to the edge of the cliff down which goes a road past a large alloy dome thirty-eight (38) foot across the bottom and with a twenty (20) foot hole in the top.

Based upon some of the aerial photographs during which the alien was caught in the open and launching - some launches appear to be coming from the direction of the dome. I would guess it is an underground launch egress facility. In the NASA CIR there is what appears to be a black limousine alongside the dome on a ramp. Surprisingly it is precisely the size of my 79 Lincoln Town Car. Wheeled vehicles and what appear to be Snow Cats or Catapillars can be seen throughout the CIR - car and truck tracks, trucks and jeeps. I don't believe aliens have wheels - humans do.

Numerous road blocks extend northward through the US base along a well maintained road thirty some-odd feet wide - apparently gravel - near all weather - numerous turn arounds and wheel tracks into launch preparation areas with the ships; pads marked with twenty-six (26) foot Xs and servicing facilities, tanks, etc. - two domed polygon high voltage buildings on north on the east side of the road, also an apparent foundation for another or a helo pad - test stands, human housing, water tank (thirty-two foot across) - and at one of the main road blocks, two large vehicles parked across the road. Also at that point another apparent black limousine with tracks leading to it to the west of the road. All tracks and vehicles have been dimensioned and match military vehicles. If I were to make a guess, I would estimate the likelihood that the apparent black limousines are CIA.

This is but a limited inventory of what was there on Sept 8, 1978 - included only as evidential matter for your perusal and confirmation. The road, which incidently the natives, the tribal chief, reservation police and highway patrolman know nothing about, comes in off of a trail from the north. Starting at the trail, line of sight to the large plateau area and the alloy dome, the road, in the middle of nowhere on the Jicarilla Reservation, is precisely 12,888 ft. long airline distance. The total alien basing area, which apparently contains several cultures(now all under the designation "Unity" in the Computer language) is approximately three (3) Km wide by eight (8) Km long. A conservative guess based upon the number of ships presently over this area and the number on the ground in the CIR and photographs, the total alien population at this point is at least two thousand (2000) and most likely more. The alien indicates more are coming or on the way.

I won't attempt to speculate in this report as to how the initial US contact was made - what transpired, nor how many were able to escape. The alien has communicated his account, and if totally true, it certainly is not palatable.

Much detail has been omitted for future discussion if desired - however the import is this. Constant computer communication - full on line in February of this year - manual prior to that - has allowed a constant accounting of what is and has been going on - conditions of morale and a total insight into "what makes the alien run". This is very valuable data.

- 1) Most importantly, the alien will allow no one to go without an implant and after knowledge of it is wiped out. They simply will not allow it. All indications are that communication or language cannot result without the implant. (with the exception of the Binary and the Computer). This would indicate a possible immediate threat or danger for anyone - military, Air Force, or otherwise that has been at the base. They will not remember the implant in any case (the contactee here included).

The reason for the implant is multiple for both language or communication by thought (there is no apparent language barrier with thought) and also complete absolute control by the alien through program - by their beam or direct contact.

I have tested this and found that during this programming the person is totally alien; once one learns to recognize the signs and the person then has no memory of the act/conversation afterward. If this has happened to the military, I need not elaborate as to the possible consequences. The victim's "switch" can be pulled at any time and at the same time they are "walking cameras and microphones" if the alien chooses to listen in with the use of their beams. No classified area of any endeavor in the US is inviolate under these conditions. However - realize - the scars, barely visible - can be seen - all are exactly located and all are accessible by x-ray.

- 2) Also note that all of the aliens - human, humanoid alike - all must have implants - without them, no direct communication is apparently possible. So one can most generally arbitrarily say that if a person states he/she communicated by thought with an alien - he/she most likely has been implanted. They may also claim to be overly psychic and be able to prove this - again through the link transplant, he/she is given the information by the alien and does not realize.
- 3) Most importantly, the alien, either through evolution or because the humanoid is made - will exhibit tendencies for bad logic (bad by earth logic comparison) so they are not infallible - in point of fact they appear to have many more frailties and weaknesses than the normal Homo Sapiens. To the alien, the mind is key and therein lies a great weakness which will be discussed later.
- 4) They are not to be trusted. It is suspected if one was considered a "friend" and if one were to call upon that "friend" in time of dire physical threat, the "friend" would quickly side with the other side.

The computer indicates in comparison, that no known earth protagonist - Russian or otherwise exhibit these tendencies to any major degree indicating the danger involved in making any kind of agreement with these aliens - at least of this species.

- 5) The alien does kill with the beam generally. Results on a human will exhibit a three to four cm purple circle. If done from the rear, on one or both shoulders. The results on cattle are the same, essentially exhibiting purple beneath the hide, with burned circles on the outside.

6) Cattle mutilations are the other side of the coin and will not be delved into here though they are a part of the overall. It appears the humanoids are fed by a formula made from human or cattle material or both and they are made from the same material by gene splicing and the use of female encounter victim's ovum. The resultant embryos are referred to by the alien as an organ. Time of gestation to full use as a utility, ready to work appears to be about one year. A year in alien time - I do not know.

Solution: I doubt there is an immediate total "cure" per se - however, they must be stopped and we have to get off dead center before we find time has run out. They are picking up and "cutting" (as the alien calls it) many people every night. Each implanted individual is apparently ready for the pull of their "switch". Whether all implants are totally effective I cannot predict, but conservatively I would estimate at least 300,000 or more in the US and at least 2,000,000 if not more worldwide.

Weaponry and Inherent Weaknesses

Weaponry is one of the keys and in the alien's present state we can prepare an effective offense.

One tends at the outset (I did) to look at their machines and say - there is no defense or offense. One is overwhelmed by their speed, apparent capability of invisibility and "cloaking", and other covert capabilities not discussed at this time. In particular - the beam weapons are themselves a direct threat and obviously one that must be seriously considered but not overly so.

Let us first look at just what this weapon is. It is an electro-static weapon with plasma generating voltages - and an internal storage device - it is pulse powered. The beam, totally effective in atmosphere can be loaded with hydrogen or oxygen. Range? Average, ground weapons - maximum two (2) Km if it is dry, capable of sustaining just so many full power discharges - slow leakage occurs continuously,

therefore, they must be recharged periodically. If it is raining the weapon becomes ineffective and is swamped, thus discharged. The range is near totally lost at that point.

On the disks and saucers, the weapon is generally on the left side or top center and has a maximum range of two hundred (200) meters at which point it will plow a trench in desert soil. When fired - it fires both to the front and to the back equally. Reason? Because of their mode and methods of flight. If equilibrium is not maintained, the saucer will spin out.

Hand weapons? Estimate based upon visible damage observed, not too much velocity nor staying power but at short range - deadly (less than a .45 cal automatic). At one meter range, estimate of beam temperature 1600°F or higher; it can vaporize metal.

Apparently the disks and weapons operate from a storage source. In time, without periodic recharge, this storage is depleted. The design they traded to us was at least thirty years old - employing an atomic source. Possibly they may still have some - it would appear so - their staying power is obviously much longer.

Aircraft Helicopter Vulnerability

Any of our aircraft, helicopters, missiles or any air flight vehicle can be taken down instantly with no use of weaponry. The alien simply need do no more than make one invisible pass and their bow wave or screen or both will take the air lift vehicle down. The pilot obviously will not even know what hit him.

For human on the ground, the alien can use weaponry or bow wave. The partial pressure envelope can hit with the power of a tornado - shock rise time and G force is instantaneous.

However, they dare not hit the craft physically because they are fragile and in fact, under slow flying conditions within our atmosphere, hold a very tenuous position.

Without power, balance or equilibrium, they lose it.

In brief - these are apparent capabilities observed and gleaned through the computer communication and observation. You may know of these, however, they are directly related to the last and final portion of this report. What can be done?

- 1) Because of the alien's apparent logic system (they appear to be logic controlled) a key decision cannot be made without higher clearance. All are under the control of what they call "The Keeper"; yet it would appear this is not the final say. Therefore, dependent upon urgency, delays of as long as twelve to fifteen hours can occur for a decision. How short/long this time frame under battle conditions may be, I do not know.

Because of this apparent control, individual instantaneous decision making by the alien is limited. If the "plan" goes even slightly out of balance or context, they become confused. Faced with this, possibly, the humanoids would be the first to break and run.

The same applies to their Mission Master Plan, if one can call it that. If pushed out of context, it will come apart - they will be exposed to the world so they will possibly run before they fight in the open. They definitely do not want that to happen.

Psychologically, at present, their morale is down - near disintegration. There is pronounced dissension in the ranks; even with the humanoids. Communication can encourage this (no necessity to expound upon this other than to say because of their own internal vulnerability mind-wise to each other, therein lies a prime weakness). Inter-echelon or individual "trust" appears to be totally lacking so suspicion of each other is rampant. They are highly segregated as to levels - a "low" dare not conflict with a "medium" or "high" or it literally means death. Death being, to the humanoid, deprogramming or, in the end perhaps total physical death.

They appear to be totally death oriented and because of this, absolutely death-fear oriented. This is a psychological advantage. The computer also gives indications of a real possibility of adverse or "ground programming".

- 2) Consider their ships - most if not near all run on charge. That source depletes and so dependent upon size - depletion can occur for some within a week or less. Ships can replenish each other but only up to charge balance. This is done with antennae-like extensions and the charge is distributed observing conservation of energy laws. They can replenish from power lines - but again only to a point - so time of flight is limited. Deprived of their base recharge capability, it is indicated that all ships will come down within six months to a year unless they can get transported out - that is back to the prime launch ship.

The disks and saucers in general cannot fly in space because of their mode of flight. Therefore, deprived of home base, it is not likely they can survive. Their capability in power survival outlasts their capability in food or formula survival. If they do not get formula/food within a certain period of time they will weaken and die.

In the case of Mt Archuleta and South Peak, they are dependent upon the Navajo River for water supply and water to them is totally life. Without water they have no power; without power, no oxygen or hydrogen to service the ships and weapons. No water to sustain the organs and feeding formula.

Simple? Not really. However, there is a water intake and there is a dam upstream that can be totally cut off and the water re-routed to Chama, New Mexico. Should this occur, at least three of the internal bases will go down. They could possibly go atomic periodically but obviously problems without cooling.

Once the bases are pressed on a large scale, all disks and saucers will go airborne immediately. Troops on the ground can gain terrain cover to quite a degree - it is rough terrain.

- 3) Our need is for a weapon, workable and preferably not like the alien's. I believe unless the alien is caught unaware (with their screen up their weapons are equal so they are like children pillow boxing) there can be no result; the weapon must penetrate their screen and it must also penetrate the ground. I believe I have that weapon. Two small prototypes have been funded and constructed by my Company. Tests conducted to date indicate they do work and work rather well considering their small size. Because of this weapon's present status and proprietary nature (a basic patent is in process), the theory will not be explained here. However, the weapon appears to do two things at very low power. 1) The disks within its range begin to discharge when exposed to the weapon beam. To counteract, they must apply more power and so doing consume more power. Again conservation of energy laws strictly apply.

This effect can be observed on the detection instruments as they back away in response to slow discharge. Discharge, at low power is slow but at high power in the final sophisticated weapon, the rate can be increased by many orders of magnitude. 2) Most importantly, this weapon can penetrate the screen - hull alloy, everything. They cannot shield it in any way. Lastly, because of the implants, the weapon's beam gets to them mentally; they lose judgement and indicate almost immediate confusion, particularly the humanoids.

It is believed at this early stage - based upon present testing that the weapon when full on and full size will kill or bring down disks at substantial range. The alien weapons operate substantially the same as their disks using a charge source and charge distribution. So, in the same sense it is indicated that this weapon design will pull their charge weapons down very rapidly.

The range of my weapon exceeds that of their present weapons and in its most sophisticated form can be readily computer controlled to allow extremely rapid tracking and lock-on regardless of speed along with electronic wobulation of the beam. It is a beam weapon and even at this early stage of miniature prototype testing and development, it indicates eventual superiority to their weapons.

4) Initial logistics would indicate a plan sequentially implemented as follows:

This plan does not include all requirements and preparatory safety measures to be employed by the ground force; however, if Air Force Intelligence desires to pursue the approaches suggested in this report, each significant requirement will be discussed in depth.

An attack must be directed near entirety on the ground for obvious reason. One would, if familiar with the alien capability, indicate that vehicle ignition problems will be encountered. This is precisely true; however, the reason for this is not mysterious but is based upon good solid laws of physics and are known. Experience gained through my study, it is now known how to prevent this from happening and will be discussed in detail at some later date. All electrical and electronic equipment must be "hardened" using these specific techniques prior to implementation. Because of the known capability of the alien (by use of scanning beams to know in advance details of planning) only the initial outline is presented in this report.

Again through the communicative interaction with the alien, testing has simultaneously been done upon this facet, i.e.eavesdropping, and ways to abort this capability have been tested and proven.

The program would be instigated in phases. The first phase - planning and logistics - would include continued implementation and testing of the final weapon prototype

thru the pre-production stage. Production of at least fifty minimum quantity should be planned. Additional backup spares should also be included.

On a full time shift basis, it is estimated that at least one year or less would be required to arrive at the pre-production stage. A team would be organized by Thunder Scientific to accomplish this. The key work is now and would be done by an associated company, Bennewitz Labs.,Ltd.

Specific attack phases would be incorporated.

- 1) The first procedure would be to close the gates of the dam above the Navajo River. This dam would be held closed for the duration. Internal to the one cave, there is a small dam for water storage. Its capacity is small. There is also a discharge outlet downstream that could be closed, causing waste water to back-up into the caves. The water is vacuum pumped apparently by some electrostatic means from the river. At close range, the weapon will take out this capability.
- 2) Once deprived totally of water for a minimum period of four weeks, conditions in the alien bases under discussion will have badly deteriorated. Psychological shock is extremely effective with the alien; total advantage can be taken by instantaneous action or planned observable deviation from the norm. At least three bases will go down.
- 3) If they follow their normal strategic patterns as when pressed previously, they will launch most if not all ships.
- 4) Prior to the implementation of water deprivation, the weapons should be deployed at strategic hardened locations and activated in a certain pre-planned manner determined by final weapon coordinate locations.
- 5) This will put an immediate power drain upon those airborne and the alien weapons ringing their bases.

- 6) Because of the inherent psychological aspect of the alien, much can be done in the open with no attempt to preserve secrecy. Much of what is done can be of a diversionary nature. Under most conditions they will attempt to harass but will not openly attack.
- 7) Throughout and prior to this, the open computer communications link will be operational for continued psychological interrogation.
- 8) At some point in time - again resting upon battle status, the deployment of offensive forces will begin. This deployment should be done in a near instantaneous manner under certain special conditions that can be discussed.
- 9) The weapon system should be kept powered up throughout. In this manner, the disks will be made to stay airborne. They cannot land in the interval the system is powered.
- 10) When the weapon is used in one specific power mode, in addition to continuous discharge on the disks that are airborne and the ground based weapons, the mind confusion and disorientation will build in those personnel at the base and underground. At the end of four to five weeks or less, all weapons should be totally discharged and power out on the bases. Most personnel if not all, will be totally incapacitated. The feeding formula will be down and its critical processing ruined. All embryos should be dead and all hydrogen and oxygen consumables depleted.
- 11) Based upon data gathered on the miniature prototype weapons, the full power weapons should have no problem holding off the disks. In many cases some will break within the first forty-eight hours without being directly hit.
- 12) At that point, standard weapon technology and logistics can come into play and used to the extent of destruction desired at the direction of those in charge.
- 13) The communications can be used throughout to determine status and near the end to attempt to instigate surrender. If no response results, then they should simply be closed in and waited out.

Summary

It is important to note that the initial implementation of the computer communications was not instigated for the purpose of talking to the alien for the "fun of it"; but was deliberately instigated to use as a tool to study, in depth, long term without physical confrontation, the strengths and weaknesses of the alien.

The weapon theory and prototypes were built to capitalize upon and test the two key and prominent weaknesses discovered. This in-house funded program has been expensive, in excess of \$200,000; done on behalf of our nation and handled in the best representative manner humanly possible.

1) The prime and weakest area discovered, probed and tested is exactly what they have used thinking it is their key strength - that being, the manipulation of and control of the mind; not only of command but also humanoid. Manipulated in reverse psychologically and by the language (computer) and due to the extreme of mental distortion and incapacity caused by the weapon, it has been found that this facet is for them a disaster and a directly vulnerable integrated weakness.

2) Though their ships are magnificent, they are also weak - solely because of their method and unique mode of flight. They do not have a stable fighting platform. Charge distribution can also be discharged. The weapon does this - even in its present miniature prototype stage.

It is not the purpose of this report to imply that the overall problem will be solved with the capture of these bases. Obviously it will not, but it is a firmly based beginning with a high degree of rated projected success ratio. It is not intended to imply the alien will not fight; they may - though their inclination is generally the opposite - this basing area is key. Without it, their mission is in very deep

trouble. It is noted that these are not the only bases on earth there are others. With a conservative estimate using typical logistic support numbers, it is not unrealistic to say there are 50,000 aliens within the ecosphere of earth and near space. Some of us will be lost in the endeavor that is obvious - however, done now the advantage is gained along with new additional technology to prepare for the next stage. The key to overall success is - they totally respect force. And with them, the most effective method is to stubbornly continue to pick and pull at their defense with no letup. Faced with the total loss of a base that has taken years to construct, it is believed that their mission will be grossly weakened and badly slowed.

As Americans, in this particular instance, we must realize - that we in this case cannot rely upon our inherent moral principles to provide the answer. Negotiation is out. This particular group can only be dealt with - no differently than one must deal with a mad dog. That method they understand. They have invaded our country our air and they are freely violating the personal and mental integrity of our people. Therefore, in eliminating this threat most certainly we cannot be called the "aggressor", because we have literally been invaded.

In final conclusion A) They cannot under any circumstances be trusted. B) They are totally deceptive and death oriented and have no moral respect for human or human life. C) No negotiation, agreement nor peaceful compromise can be settled upon in any way. D) No agreement signed by both parties will ever be adhered to nor recognized and respected by the alien, though they might attempt to make us believe otherwise. E) Absolutely no quarter can be allowed under any circumstances. Once the offense is instigated, it cannot be abandoned. If it is, reciprocal reprisal will immediately result. They must be made to come down - destruct themselves which is a standing order if the ship is failing or leave earth immediately - no leeway of any kind can be allowed nor tolerated.

COMPLAINT FORM

HA 1V05

ADMINISTRATIVE DATA

TITLE KIRTLAND AFB, NM, 8 Aug - 3 Sep 80, Alleged Sightings of Unidentified Aerial Lights in Restricted Test Range.	DATE	TIME
	2 - 9 Sept 80	1200
	PLACE	
	AFOSI Det 1700, Kirtland AFB, NM	
	HOW RECEIVED	
	<input checked="" type="checkbox"/> IN PERSON	<input type="checkbox"/> TELEPHONICALLY
SOURCE AND EVALUATION		
MAJOR ERNEST E. EDWARDS		
RESIDENCE OR BUSINESS ADDRESS		PHONE
Commander, 1608 SPS, Manzano Kirtland AFB, NM		4-7516
CR <u>44</u> APPLIES		

SUMMARY OF INFORMATION

REMARKS

- On 2 Sept 80, SOURCE related on 8 Aug 80, three Security Policemen assigned to 1608 SPS, KAFB, NM, on duty inside the Manzano Weapons Storage Area sighted an unidentified light in the air that traveled from North to South over the Coyote Canyon area of the Department of Defense Restricted Test Range on KAFB, NM. The Security Policemen identified as: SSGT STEPHEN FERENZ, Area Supervisor, AIC MARTIN W. RIST and AMN ANTHONY D. FRAZIER, were later interviewed separately by SOURCE and all three related the same statement; At approximately 2350hrs., while on duty in Charlie Sector, East Side of Manzano, the three observed a very bright light in the sky approximately 3 miles North-North East of their position. The light traveled with great speed and stopped suddenly in the sky over Coyote Canyon. The three first thought the object was a helicopter, however, after observing the strange aerial maneuvers (stop and go), they felt a helicopter couldn't have performed such skills. The light landed in the Coyote Canyon area. Sometime later, three witnessed the light take off and leave proceeding straight up at a high speed and disappear.
- Central Security Control (CSC) inside Manzano, contacted Sandia Security, who conducts frequent building checks on two alarmed structures in the area. They advised that a patrol was already in the area and would investigate.
- On 11 Aug 80, RUSS CURTIS, Sandia Security, advised that on 9 Aug 80, a Sandia Security Guard, (who wishes his name not be divulged for fear of harassment), related the following: At approximately 0020hrs., he was driving East on the Coyote Canyon access road on a routine building check of an alarmed structure. As he approached the structure he observed a bright light near the ground behind the structure. He also observed an object he first thought was a helicopter. But after driving closer, he observed a round disk shaped object. He attempted to radio for a back up patrol but his radio would not work. As he approached the object on foot armed with a shotgun, the object took off in a vertical direction at a high rate of speed. The guard was a former helicopter mechanic in the U.S. Army and stated the object he observed was not a helicopter.
- SOURCE advised on 22 Aug 80, three other security policemen observed the same

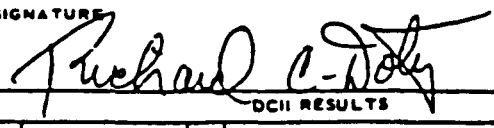
DATE FORWARDED HQ AFOSI		AFOSI FORM 88 ATTACHED <input type="checkbox"/> YES <input type="checkbox"/> NO	
HA 1V05 10 Aug 80			
DATE	TYPED OR PRINTED NAME OF SPECIAL AGENT	SIGNATURE	
8 Sept 80	RICHARD C. DOTY, SA		
DISTRICT FILE NO.		DCII RESULTS	
8017A 93-0/27		<input type="checkbox"/> NEGATIVE <input type="checkbox"/> POSITIVE (See Attached)	

aerial phenomena described by the first three. Again the object landed in Coyote Canyon. They did not see the object take off.

5. Coyote Canyon is part of a large restricted test range used by the Air Force Weapons Laboratory, Sandia Laboratories, Defense Nuclear Agency, and the Department of Energy. The range was formerly patrolled by Sandia Security, however, they only conduct building checks there now.

6. On 10 Aug 80, a New Mexico State Patrolman sighted an aerial object land in the Manzano's between Belen and Albuquerque, NM. The Patrolman reported the sighting to the Kirtland AFB Command Post, who later referred the patrolman to the AFOSI Dist 17. AFOSI Dist 17 advised the patrolman to make a report through his own agency. On 11 Aug 80, the Kirtland Public Information office advised the patrolman the USAF no longer investigates such sightings unless they occur on a USAF base.

7. WRITER contacted all the agencies who utilized the test range and it was learned no aerial tests are conducted in the Coyote Canyon area. Only ground tests are conducted.

8. On 8 Sept 80, WRITER learned from Sandia Security that another Security Guard observed a object land near an alarmed structure sometime during the first week of August, but did not report it until just recently for fear of harassment.

9. The two alarmed structures located within the area contains HQ CR 44 material.

MULT. PURPOSE INTERNAL OSI FORM
(Complete only applicable items)

TO	DO NO.(S)	SUBJECT	FILE NO.	
	DET NO.(S)			8017D93-0/29
	HEADQUARTERS IVOS			TRANSMITTAL DATE
FROM	DO NO.	KIRTLAND AFB, NM, 8 Aug - 3 Sep 80, Alleged Sightings of Unidentified Aerial Lights In Restricted Test Range	26 Nov 80	
	DET NO.		SUSPENSE DATE	
	HEADQUARTERS			

REFERENCE

AFOSI Form 96, 28 Oct 80, Same Title

MINOR DISCREPANCIES NOTED ARE LISTED BELOW.

YOUR DISTRICT IS DESIGNATED OFFICE OF ORIGIN.

ATTACHED REQUIRES INVESTIGATION IN YOUR AREA.

DETERMINE SUBJECTS ACCESS TO CLASSIFIED INFORMATION AS REQUIRED BY OSIM 124-1, PARA 2-6-3.

FORWARD RESULTS DIRECTLY TO OFFICE OF ORIGIN, OR TO:

NO FURTHER INVESTIGATION CONTEMPLATED.

OUR FILES REFLECT PRIOR INVESTIGATION BY _____, DTD _____, FILE _____; If copy of this report is requested to furnish copies of prior investigation/letter summary, if applicable, to _____

REPORT OF PRIOR INVESTIGATION/SUMMARY ATTACHED.

INVESTIGATION CONTINUING AND YOU WILL BE FURNISHED FURTHER REPORTS

DISCONTINUE INVESTIGATION. FORWARD RESULTS OF ANY INVESTIGATION ACCOMPLISHED.

DISCREPANCIES BETWEEN LEAD REQUEST AND DEVELOPED INFORMATION ARE SET FORTH.

REPORT OF COMMAND ACTION HAS NOT BEEN RECEIVED.

REQUEST STATUS OF THIS MATTER AND/OR DATE REPORT MAY BE EXPECTED. (Requester, forward 3 copies of this form.) (Recipient, use received copy for answer with proper signature in remarks section unless OSI directives state reply not required.)

REFER ATTACHED TO INTERESTED COMMANDER FOR INFORMATION OR ACTION IF NOT PREVIOUSLY REPORTED.

CHECK WORLD-WIDE LOCATOR FOR BELOW LISTED PERSON OR SUBJECT

ATTACHED IS FORWARDED FOR INFORMATION AND/OR ACTION.

UPON REMOVAL OF ATTACHMENT(S) _____ THE CLASSIFICATION ON THIS CORRESPONDENCE WILL

RETAINED. DOWNGRADED TO _____ CANCELED. MARKED "FOR OFFICIAL USE ONLY."

(// classification is retained, with or without attachments, indicate reason for security classification and grouping per AFR 205-1.)

REMARKS

1. On 10 Nov 80, a meeting took place in 1606 ABW/CC Conference Room attended by the following individuals: BGen WILLIAM BROOKSHER, AFOSP/CC, COL JACK W. SHEPPARD 1606 ABW/CC, COL THOMAS SIMMONS 1606 ABW/CV, COL CRES BACA, 1606 SPGp/CC, COL FRANK M. HUEY, AFOSI Dist 17/CC, LTC JOE R. LAMPORT, 1606 ABW/SJ, MAJ THOMAS A. CSEH, AFOSI Det 1700/CC, Dr. LEHMAN, Director, AFWL, ED BREEN, AFWL. Instrumentations Specialist and Dr. PAUL F. BENNEWITZ, President Thunder Scientific Laboratory, Albuquerque. Dr. BENNEWITZ presented film and photographs of alleged unidentified Aerial Objects photographed over KAFB, NM during the last 15 months. Dr. BENNEWITZ also related he had documented proof that he was in contact with the aliens flying the objects. At the conclusion of the presentation, Dr. BENNEWITZ expressed an interest in obtaining financial assistance from the USAF in furthering his investigation regarding these objects. DR. LEHMAN advised DR. BENNEWITZ to request a USAF grant for research. DR. LEHMAN advised DR. BENNEWITZ he would assist him in filling out the proper documents.

2. On 17 Nov 80, SA RICHARD C. DOTY, advised DR. BENNEWITZ that AFOSI would not become involved in the investigation of these objects. DR. BENNEWITZ was advised

COPIES TO	ATTACHMENTS	FILE STAMP AND/OR OTHER
Dist 17-IVO, File		8017D93-0/29 x 2
NAME GRADE TITLE SIGNATURE		
THOMAS A. CSEH, Major, USAF Commander Base Investigative Detachment		
	FOR-OFFICIAL-USE-ONLY	

that AFOSI was not in a position to evaluate the information and photographs he has collected, to date or technically investigate such matters.

3. On 26 Nov 80, SA DOTY received a phone call from an individual who identified himself as U.S. Senator HARRISON SCHMIDT, of New Mexico. SEN SCHMIDT inquired about AFOSI'S role in investigating the aerial phenomena reported by Dr. BENNEWITZ. SA DOTY advised SEN SCHMIDT that AFOSI was not investigating the phenomena. SA DOTY then politely referred SEN SCHMIDT to AFOSI Dist 17/CC. SEN SCHMIDT declined to speak with 17/CC and informed SA DOTY he would request that SAF look into the matter and determine what USAF agency should investigate the phenomena.

Auth: 1201

4. It should be noted that DR. BENNEWITZ has had a number of conversations with SEN SCHMIDT during the last few months regarding BENNEWITZ'S private research. SEN SCHMIDT has made telephone calls to BGEN BROOKSHER, AFOSP/CC regarding the matter since Security Police are responsible for the security of Manzano Storage Area.

IN REPLY TO	AFOSI COMMUNICATION	DATE OF TRANSMITTAL 30 July 1981
TO: <i>AFOSI/CC</i> <i>CCB</i> <i>120601</i> <i>CC-Info</i> <i>[Signature]</i>	SUBJECT Dr. PAUL FREDRICK BENNEWITZ Congressional Inquiry	
FROM: AFOSI District 17/CC Kirtland AFB, NM 87117		
REFERENCE 8017D93-0/29		
ITEMS CHECKED ARE APPLICABLE TO ABOVE SUBJECT		
<input type="checkbox"/> INVESTIGATION HAS BEEN INITIATED AND REPORTS WILL BE FORWARDED AS SOON AS POSSIBLE.		
THIS MATTER IS <input type="checkbox"/> PENDING <input type="checkbox"/> CLOSED.		
REQUEST REPORT OF ACTION TAKEN (AFR 124-4).		
NOTE RESTRICTIVE LEGENDS ON FRONT OF THE ATTACHMENT(S).		
REQUEST INSTRUCTIONS AS TO DISPOSITION OF EVIDENCE LISTED BELOW.		
ATTACHED IS AN INTELLIGENCE INFORMATION REPORT (IIR) TRANSMITTED ELECTRICALLY IN THE INTERESTS OF TIME-LINESS. NUMERICAL DESIGNATORS IN THE IIR ARE AS FOLLOWS: 1. COUNTRY; 2. REPORT NUMBER; 3. TITLE; 4. PROJECT NUMBER; 5. DATE OF INFORMATION; 6. DATE OF REPORT; 7. DATE AND PLACE OF ACQUISITION; 8. REFERENCES; 9. ASSESSMENT; 10. ORIGINATOR; 11. REQUEST EVALUATION; 12. PREPARING OFFICER; 13. APPROVING AUTHORITY; 14. SOURCE.		
ATTACHED IS AN INFORMATION COLLECTION REPORT (ICR) WHICH CONTAINS INFORMATION CONCERNING AN INDIVIDUAL UNDER YOUR COMMAND. THE ICR IS FURNISHED FOR YOUR INFORMATION ONLY AND IT DOES NOT CONSTITUTE A FORMAL OR COMPLETE INVESTIGATION OF THE INDIVIDUAL. IF A FORMAL INVESTIGATION IS WARRANTED, IT SHOULD BE REQUESTED IN ACCORDANCE WITH AFR 124-4.		
THE ATTACHED REPORT HAS BEEN LOANED TO THE USAF BY ANOTHER AGENCY. DISSEMINATION OF THAT REPORT TO ANOTHER AGENCY OR ITS PERMANENT INCORPORATION INTO ANY USAF RECORDS SYSTEM WILL NOT BE MADE WITHOUT PRIOR APPROVAL OF THE ORIGINATING AGENCY. WHEN THIS REPORT HAS SERVED ITS PURPOSE, IT WILL BE DESTROYED; NO RECORD OF THE REPORT IS BEING MAINTAINED BY AFOSI.		
WHEN ATTACHMENT(S) IS/ARE REMOVED. THE CLASSIFICATION OF THIS CORRESPONDENCE WILL BE <input type="checkbox"/> RETAINED <input type="checkbox"/> DOWNGRADED TO <input type="checkbox"/> CANCELED <input type="checkbox"/> MARKED "FOR OFFICIAL USE ONLY"		
OTHER/REMARKS On 30 Jul 81, the 1606th ABW IG contacted DO 17/BID and advised that Senator PETER DOMENICI desired to talk to SA RICK DOTY regarding the matter involving BENNEWITZ. After checking with Col HARVELL, Acting AFOSI/CC, it was agreed SA DOTY and DO 17/CC would meet with Senator DOMENICI. Senator DOMENICI was present in the IG's Office but departed immediately to meet with BENNEWITZ. A subsequent check with Mr. TIJEROS, Senator DOMENICI's Aide, in an effort to determine the Senator's specific questions, determined his sole interest was to know whether AFOSI had conducted a formal investigation of SUBJECT. Mr. TIJEROS was informed that no formal investigation of BENNEWITZ was conducted by AFOSI. Mr. TIJEROS stated that he assumed if any information were available, and was to be requested from AFOSI, it would have to be requested from our Headquarters. He was provided Col BEYEA's name and the Bolling AFB address of our HQ AFOSI in event he desired any further information. Mr. TIJEROS thanked us and indicated no further inquiries from the Senator regarding this matter are anticipated.		
NAME, GRADE, TITLE, SIGNATURE <i>Frank M. Huey</i> FRANK M. HUEY, Colonel, USAF Commander	ATTACHMENTS	COPIES TO HQ AFOSI/IVOS File <i>[Signature]</i>
FOR OFFICIAL USE ONLY		

8017D93-0/29x

ABDUCTION BY ALIEN ENTITIES

"A Sleeping Army" may have been a government term used to name the abductees as a group, presumably because they were mostly unaware of being abductees and because they could be used, via brain implants, by the alien nation of abductors.

This may have been in reference to Grey and/or Blond abductees or contactees or to everyone who has ever been involved with any kind of alien. There may be many different "kinds" of abduction and many different reasons for contact.

If some of the implications are valid, we are all subject to influence through the media and other mass methods. No matter who is really "behind" or in control of the various forms of media, we know the press has always been a major part of the UFO subject in general.

Could It Happen To You?

Yes, conceivably. The numbers of people who have already been abducted are apparently very high. There is so much contact and revelation going on in our society now that your chances of contact or of discovering involvement are steadily going up.

It would seem that almost anyone can be abducted, that all phases of human existence are interesting to aliens of one kind or another. Anyone can be chosen, from the poorest, least educated to the most economically and politically powerful people, regardless of age, race, or religious conviction. And, contrary to popular belief, as many men are abducted as women.

There is also much indication that most of the abductees and contactees, as a group, are not aware of their connections. The gradual "awakening" of this group is both predicted and said to be occurring now.

Multiple Abductions - Multiple Witnesses

Abduction is not necessarily an experience that one undergoes alone. In fact, one study shows that in 24% of the cases reviewed there were multiple witnesses to the abduction. There was one case in Connecticut where seven people from three different cars were involved in an abduction event.

Another case involves 221 United States Army troops at Fort Ord in 1961. In this case, soldiers were out on exercise when one or more craft descended and abducted them, implanted them and left them dazed on the ground. Some of the troops looked up and saw the disks flying away and vomited, which indicates a programmed response inserted by the aliens.

As the troops were coming out of their daze, approximately 600 fresh troops from Fort Ord descended on them and sequestered them and their families for a period of time. This operation involved pre-knowledge on the part of the United States Army - they already had a plan in hand to use soldiers to sequester other soldiers in case of a mass abduction. To come up with 600 men immediately after a mass abduction suggests that things were extremely organized to start with - remember, this is 1961.

Contactees And Abductees

Rather than labeling people, these terms should be converted to label experience - contact and abduction: contact being sighting or communicating with aliens, or engaging in more complicated interaction with the aliens of your own free will - abduction being taken or manipulated by aliens (or government abductors) without your consent or without your knowledge.

It should be understood that many or most people with either contact or abduction experience have had both kinds of experience in different ways throughout the interaction.

People who are aware of their own involvement with aliens tend to refer to themselves generally as contactees or abductees. This generally expresses positive or negative interaction.

We will now discuss several different "kinds" of contact, or the major and most interesting themes running through the testimony in our solid research cases. As of yet, we have not been able to test the population as a whole enough to form a more holistic picture of the contact situation. For now, we can only report our prominent findings.

"Blond" Humanoid Contact

Any apparent alien who is essentially human and Caucasian in appearance, even though sometimes very tall, may be called a Blond. Though many are tall, blond haired and blue eyed, certainly all are not. Even some of the American Indian connection may be considered Blond in origin. There are actually many factions of these aliens, from different places, with different motivations, though they are generally held to be good-guys.

A large percentage of those who report contact with the Blonds claim that there are many "chosen ones" who are just now being made aware of their involvement, or who will be in the near future.

Many such contactees are told that they are descendants of the Blond spacemen, or even direct, half-breed, Blond-human beings. Many have no apparent contact until they are adults and most seem to have positive experiences with the aliens. They are frequently told there are many more people on earth like them and that they will all be "finding" each other as time goes on.

We also have multiple cases of Grey abductees being contacted by Blonds after long experience with the Greys. They were then protected in some way from influence by the Greys, apparently saved from the Greys by the Blonds, often by implant technology.

Just as with the Blond aliens themselves, their contactees are often fair colored and blue eyed. But not always. Though there is a strong suggestion that genetics or bloodlines are important to the aliens, they engage in contact regardless of color. This implies that even minute traces of whatever interests the aliens are present in your ancestry, no matter what your racial background, can subject you to their attention.

The purpose of much Blond contact seems to be to expand awareness of the contactees and society en mass. Some contactees have been told that they were put here to do a job of some kind, often teaching or helping others prepare for coming world disasters. Some have been told that they are to be freedom fighters in the "New World" after those disasters. Many have been told they would be taken away to another, better world, or just taken off this world until danger passes and then be put back to recreate the New World.

Many of the contactees who have been miraculously cured by the aliens, or who are living in communities waiting to be picked up by aliens, are Blond contactees of some kind. Our "Space Brothers" may focus their contact on people with certain spiritual development or mental evolvment, as well as on their own descendants. Many channels and "walk-ins" (discussed later in this chapter) are connected with the Blonds in some way.

*** "Blond" Humanoids Genetically Engineered by the United States ***

Once researchers discovered that the United States, Soviet Union and other countries had bases already on the Moon, they looked a little further and discovered that ever since the first covert probe hit Mars in the early 1960's, NASA (which was basically founded with ex-Nazi intelligence and scientific personnel, just like the CIA) has already had a generation of *genetically engineered humans* born in space. Some of these tall blonds have been seen in Nevada and California. Also known as the "Benevolent Ones", they are under US control and jurisdiction. Part of the acclimation program. Some are masquerading as "Pleiadians". Due to Robert Lazar in 1989, we know that the United States has craft of that type and others in Nevada.

The Adrian Story

A woman who wishes to be known only as "Adrian" gave this account of her experiences, which were remembered without the help of hypnosis.

"When I was a little girl, back in 1948, I had a very traumatic experience. The odd thing about it was that I was too young to remember what happened, but for about three decades afterward I experienced a post-traumatic stress syndrome. It happened when I was 18 months old, around December of 1948 or early 1949.

My parents don't remember what happened to me, either, which I think is very odd. It wasn't child abuse, because I was never abused as a child. I never was seriously ill or in an accident or anything like that. I had everything going for me. I was born into a very loving family. Up until that time, I was a very happy outgoing baby. Then something happened to me at 18 months, and things were never the same again.

I'm still not sure what happened. The circumstances surrounding what happened to me are not clear. I was ill at the time with a high fever. It wasn't serious, just tonsillitis. During this illness, at one point I went into a deep sleep which lasted for 18 hours. When I woke up, I had this personality change. I became very fearful of everything, particularly flashing lights and medical exams. I was no longer friendly. I didn't want anybody touching me, especially doctors. I became so aggressive that doctors no longer wanted to deal with me.

Photos exist of me that were taken prior to this incident with a flash-bulb camera, in which I was happy and smiling. There had never been any difficulty about taking indoor photos of me with a flash-bulb camera, but from one day to the next this suddenly threw me into hysterics, because I could no longer stand flashing lights.

I stopped talking for almost a year after the incident. My life started to take on a holding pattern. At the age of three, my I.Q. was that of an 18 month old child. The experts told my mother that I was retarded, and should not be sent to public school. But my mother didn't believe the experts, because I had been developing normally until the age of 18 months, when the trauma happened.

My parents were healthy. My family wasn't rich, but we were getting by. I was born into a stable, middle-class nuclear family in a large city. My parents loved me. I was the first girl born into the family, and I was treated like a princess. I was charming and outgoing and pretty and very friendly with people. Then overnight I changed abruptly.

My memory of my second year of life is completely blocked. From the time I was about three, I had an intense fascination with those jack-o-lanterns that they used to make on Halloween. I didn't realize it then, but the faces on those pumpkins resembled ETs. But back in 1950, I was too young to realize it. I remember when I saw my mother coming out of the candy store with one of those jack-o-lanterns. She was smiling, holding it up for me. The next thing I knew was that whenever I saw those faces, I had to have those jack-o-lanterns in the worst way. I would get this rip-roaring emotion of euphoria whenever I saw those faces. I had a lot of weird dreams concerning those jack-o-lanterns, those cardboard "pumpkins".

I also started having dreams about being in an airplane. In the dreams, I was in the cockpit, wearing a navy blue snow suit, sitting next to the pilot who was wearing a black flightsuit.

When I was about four or five, I had a frightening nightmare about floating up to the ceiling and being unable to move. I tried to call out to my mother, but I couldn't speak. Besides, she didn't seem to notice or even care.

When I was eight or nine, I learned about outer space and heard of the science fiction myth of flying saucers. Even though I was told that they were not real, I still couldn't stop thinking with all my heart that they were real. This was before the launching of Sputnik. I asked my mother if she knew what people on other planets looked like. I was hoping in the worst way that she would say that outer space beings are tiny, bald and beautiful. But all she told me was that the experts don't know.

I started developing an idea of what I wanted a being from outer space to look like, as well as what I wanted human beings to look like and what I wanted to look like myself. My idea of beauty was (and is) somebody three to four feet tall with a large head, large black slanted eyes, small nose or no nose at all, narrow shoulders and hips, very slight and childlike build, and very thin limbs. Then I established my standards of what is beautiful, I was subconsciously imprinted on humanoids rather than humans. Although I was not aware of it, I already know what an extraterrestrial looks like, even down to the minutest detail, such as the tiny ears with undeveloped earlobes, and the undeveloped teeth.

When I was eleven and all my classmates loved the Disney cartoon characters such as Mickey Mouse and Snow White, my favorite characters were "The Little Space Girl" and "The Man From Planet X". My favorite children's book was Zip-Zip and His Flying Saucer.

Extra-terrestrials became the most important thing in my life. Nothing else in life mattered. They were all I would ever think about, 24 hours a day. I couldn't concentrate in school. I failed subjects and got left back. Eventually I had to leave school. My post-trauma stress syndrome worsened during puberty. Not only did I have to leave school, I had to leave home and go to a foster home. I lost all my friends. People no longer respected me. I never saw my

friends again.

Adolescence was very difficult. I started growing, but I didn't want to be five feet four. I wanted to be four feet tall. I became very bitter about that, but people didn't understand. They thought that it was because I was afraid to grow up, that I didn't want to grow up because I wanted Mommy to take care of me forever, but that wasn't true. There was no way to prove it wasn't true. Nobody understood. I felt like an alien trapped inside a human body. I didn't want to be a human being. I wanted to be an alien, but my family and society kept pressuring me to be human. I felt like I was being pulled at both ends, like taffy candy. I wanted to break away from my human heritage, but I couldn't. I had an unresolved human vs. alien conflict.

I didn't want to date. I was not even attracted to the opposite sex of my own species. In fact, I found humans disgusting. I even hated to look at them. I was upset that my head was too small for my body. My head was too small, my eyebrows were too hairy, I was too tall. But I couldn't tell a therapist what was bothering me, because he wouldn't have understood, and would have thought I was crazy. I kept this bottled up inside me for years, but I couldn't help dwelling on it. It will bother me for the rest of my life.

As an adolescent, I decided that I didn't want to marry. I decided that I would never marry a human being. The only person I would ever marry would be an extra-terrestrial. I didn't want to bear human children. If I couldn't bear alien children, I didn't want any children at all. I didn't want to marry unless I could marry into an alien culture. Of course, 'Mr. Right' never did come along, so I remained single for the rest of my life. But I still have daydreams of a portrait of me and my future husband, who is tiny, bald and handsome, and of our kids, two or three bald little kids.

In my early teens, I was not as emotionally mature as my peers, because I never learned to relate to other humans. I still read children's books. I still play with dolls. One day I discovered a book called *The Wonderful Flight to the Mushroom Planet*, which is about a race of tiny bald beings. The book inspired me to shave the hair off my dolls, to make my dolls bald. I even did this to my expensive Shirley Temple doll.

I was a talented artist, but all I ever drew were portraits of extra-terrestrials, in which none of the main characters were human.

People made fun of me, and called me "disturbed". My foster guardians tried to stop me from writing "crazy stories", even though I was really doing serious writing. They became very abusive.

I tried to do better in school, to catch up and be like the other kids. Therapists considered me to be emotionally disturbed or mentally ill, because they didn't recognize the post-trauma symptoms. They said they my love for outer space was part of my "sickness". They said I

was that way because my parents were not good parents, that they spoiled me, that I was raised in a bad environment.

Finally I decided to work hard and catch up in school. It was very difficult, because I was four years behind my peers. I couldn't even read a newspaper, though I could read. My vocabulary was weak, so I found it hard to carry on intelligent conversations. People called me stupid. I wondered if I was retarded. Sometimes I believed I was retarded and feared that I would never lead a normal life.

I didn't even have the support of my parents. There was something alien that my parents resented. They miss the original little girl who "died" in 1948. They want the old child back, but she is dead and will never come back. A new child appeared, a changeling, a new child who possessed something alien within her. My parents found it hard to love this new child as much as the one who had "passed away". They went through a period of mourning, as if they had actually lost a child.

They resented me for being different. I wasn't the way I was born. They wanted me to change back to my original self, but I couldn't. They resented me because of this, and were very bitter against me. Their anger made me feel uncomfortable, as if I was to blame, and I felt very guilty. I started to feel cheap and dirty because I didn't want to be human. I felt as if I was the only one in the world in this situation. I felt isolated.

My mother also felt guilty. She got depressed and blamed herself. Maybe she did something wrong during her pregnancy. Maybe the therapists were right, maybe she was a bad mother, spoiling me and giving in to me. My father also blamed my mother for this mess. My brother resented me, too. The marriage became strained. There was a lot of anger and bitterness in my family. I felt uncomfortable during my visits home, I felt that they were strangers, that they didn't know me any more. I felt like I was an intruder, like I was imposing on them. I felt that everything was my fault.

Eventually I pulled my marks up well enough to go to summer school. I even began to get high marks, particularly in math, which was my strongest subject. But like a foreigner, I didn't do well in subjects involving verbal skills, like English or History, which involve many essay exams.

I was allowed to return home, even though my family didn't want me to return home. Although they said they loved me very much, they seemed to prefer me not to exist, but I returned home anyway. I kept to myself, cautious not to bother my family. I refrained from having long conversations with my father and siblings. I refrained from talking about outer space, especially if my grade average was below A. I got a B plus average during my senior year in high school, and graduated at 19.

During adolescence, I started developing stress-related health

problems, such as uncontrollable high blood pressure, which is uncommon in teenagers, and severe headaches. In my twenties, I developed asthma and had some serious breathing problems.

During my twenties, I didn't make any friends. I didn't socialize at all, because I couldn't carry on a conversation, not even over a telephone. But I went on to college, and got a job as a laboratory technician. Eventually I got a Masters degree.

I put on a facade, acting like a normal person. Some people still think I'm a little weird, even though I don't reveal my real self or talk about space, ever. I lead a solitary life.

The aliens have no concept of modesty, as externally they are not sexually developed. They have bodies like children, and thus have nothing to hide. Society on a crowded mothership is like a third world country. There are no luxuries, like privacy. Everything is in the public domain. It is like a Marxist government, since no one owns anything, and most of them are poor.

The ones that carry out the abductions are the cream of the crop, high-ranking mission specialists. For each one of them, there are tens of thousands who did not make the grade. What the abductees are seeing is not a true representation of alien society. They are not seeing the common folk. They are not seeing the alien children, who are terminally ill with progeria (premature senility), because the DNA in their bodies is not replicating properly.

The condition of these children is the real motivation for the hybridization experiments being carried out on Earth. Millions of years of too much in-breeding has produced a weak race. Some human children have progeria also, but it is still a very rare disease among humans. The aliens are such an ancient race that their DNA is worn out. Their genes are breaking down. The DNA in their cells cannot replicate properly. Progeria has become so common that it is considered to be a normal condition. As they fail to reach sexual maturity, they resort to cloning and in vitro fertilization. They don't metabolize fat well, and are vulnerable to a host of genetic diseases. Many of the cosmonauts are prone to leukemia, because of over-exposure to electromagnetic radiation from the propulsion systems of their starships.

As so many of their offspring and loved ones die, they are trained from early childhood not to feel emotion. They repress all of their emotions, because they don't want to feel pain. They don't even want to talk about progeria. Its a form of self-denial. They tell humans that they are a superior race, that they don't age, but that's not true. They don't die of old age, because they don't live long enough to die of old age. They die of progeria.

There is an old saying: "Gee, he looks like he came from outer space!" I have heard that many times when people were being made fun of. I think such a remark is very racist, not only against the human being, but also against the extra-terrestrial community. So what if

someone looks like he or she came from outer space? Big deal! We all come from the stars, anyway. Every atom in our bodies originated in a supernova somewhere.

I'm at work on a novel, a love story about two aliens. If and when the aliens come to Earth on a mass scale, I would like to be an Ambassador."

The Story of Adrian is from "Extraterrestrial Friends and Foes" by George Andrews and Barbara Bartholic, Llewellyn Books, 1989/90, and is used with permission.

Other Contactees

There are many others who feel that they are somehow both alien and human, whether they were aliens in past lives or are currently walk-ins or just sometimes share awareness with aliens.

As our research turns up more information we will be presenting it. In the meantime, we ask all readers who feel they may have something to contribute to the store of information to write in to us about their experiences.

What happens when you're Abducted?

Abduction by alien entities is a reality shaking experience for many people. The technologies involved allow the aliens to control virtually every aspect of an individuals perception, experience, and memory. A significant portion of those abducted remember the experience without hypnotic regression.

These extraterrestrial biological entities (EBE) have complete mastery over both human biogenetic systems and the finer biofields than encompass areas all the way to the astral and beyond. More data later on in the book.

"Service to Self Scenarios"

Typically, individuals are taken and subjected to testing, examination and manipulation. Biological monitoring and control implants are inserted and the individual is then released. There have also been cases where humans were mutilated (in the same way cattle are mutilated) while still alive - parts of their bodies literally sliced away - in order to secure biological materials for nourishment or genetic projects under alien (Grey)control. Blond humanoids have

been seen in approximately 60% of cases working along with the Greys.

Genetic cross breeding work involves subjecting human females to "short-run" pregnancies of approximately three months, after which the cross-bred fetus is removed and the female returned, usually unaware of the experience.

Some cases indicate that newly fertilized eggs (fertilized with alien sperm) are inserted at the same time that a cross-bred fetus is removed, which results in a constant state of pregnancy for significant periods of time.

"Service to Others Scenario"

In contrast, alien entities have also used their technology to help individuals with biological problems. They have resolved cases of AIDS by introducing electromagnetic frequencies that resonate with the mortal oscillatory frequency of the virus, which is crystalline in structure, effectively causing viral disruption. They have also effected cures on humans for many other diseases . Some of the blond humanoid races are also involved in teaching people and helping them to raise their awareness.

What are the Major Effects of Abduction?

In a significant number of abduction cases, the involvement of the individual is "buried" within missing time, which is essentially an applied memory block. Both the EBEs and the abductee can create memory blocks to the events. Missing time is not always a factor in abduction, although it is a good indicator.

Psychic trauma is the predominant factor once memory is restored to the abductee. The exact nature of this trauma and possible resolutions to the trauma will be discussed later in the book.

Physical trauma is also a factor in abductions. Individuals have been poked, prodded and generally manipulated to the point where physical symptoms start to appear. This is the most obvious feature of abductions. The bruises, surgical scars and visible features that do not correspond to "normal" events cry for an explanation. We'll discuss these in detail in the book.

Memory Loss

Memory loss is a primary effect of abduction cases, and is apparent in most cases, but not all. It should be noted that only a very small percentage of the potential cases have been investigated. Despite the high number of cases now on the files, indications are that the majority of the abductee population is as yet unaware of their involvement.

There seem to be two primary thoughts with regard to memory loss. The first follows a theory which holds that memory loss is a manifestation of the unconscious mind to protect the conscious mind.

Another observation is that slowly pulsed microwaves will also create gaps in memory. Emissions from some aerial machines include microwave frequencies, but this does not preclude direct application of microwave frequencies to subjects or neural alteration.

Probably, both factors play a part. It would seem that most memories of abduction experiences are erased as easily as a light is switched off.

General Manipulation

Mental, as well as physical, manipulation is obviously occurring throughout the entire experience. Any abductee who claims that "they couldn't possibly be manipulating me" is not yet ready for the true challenges of this experience - mind control - something that everyone who is abducted may be subjected to no matter what their value to the aliens may be.

Beacon Abductees

It has been related to us that there are beacon abductees and receivers - and that as the beacons undergo an abduction, they transmit the experience to the receivers, who feel as if they themselves are having the experience. We were also told of a person who is involved in "deprogramming the beacons, thereby also releasing the group of receivers from the alien influence.

While this is the first we've heard of this aspect of the abduction experience, the above may very well be true. We do know that "implant connections" exist between abductees. We also know that our case files contain but a small percentage of the whole abductee population. They may all be beacons. It is possible that the receivers, for the most part, are still unaware of the experience.



Abduction By Greys

There is a very large number of Grey abductees living all over the world. Most are either unaware or just partially aware of their involvement with the aliens. Abductee, Cynthia Crowell¹, described the abductees as a group as "... currently hovering on the edge of an awareness that we are somehow different. The tendency is to relate this "difference" only to ourselves and not to anything external, certainly not to real aliens. More and more of us are becoming aware of our experiences and our identity within the larger society that also includes the aliens."

Grey abductees seem to be taken for a large variety of reasons, some apparently having nothing to do with the person him/herself.

They might have been manipulated, to various degrees, for no other reason other than that they were with a person scheduled to be abducted. Others have been abducted apparently only once or very rarely, compared to most, who have repeated experiences throughout life. As with Blond contactees, it would seem that genetics or racial background plays a part in their selection processes.

One thing is apparent; people have been abducted by Greys for a long time. We have many cases where the abductee may be the third or fourth generation in his or her family to experience this contact. We also have one case who is aware of having had Grey contact also in her last lifetime, which was as a Jew in Germany's deathcamps during the holocaust. She recalls not only experience with the Greys during that time, but contact with the same Grey "person" she has seen repeatedly in this lifetime!

There is some indication that a large percentage of the "sleeping army" was picked up only once or twice and implanted, but not generally bothered or contacted throughout their lives. This suggests that these people are "on-hold" for something, or that they are simply walking transmitters of some kind of information back to the aliens.

¹ See "The Government Factor" by Cynthia Crowell elsewhere in this book. Also in "Alien Magic" by researcher William Hamilton, entitled "Report #1 by Cynthia Crowell" available by contacting Mr. Hamilton at the UFO Research Center for Extraterrestrial Studies, 249 North Brand, #651, Glendale, California 91203.

In October of 1989, we heard reports that the aliens are training the abductees on weapons and in aircraft, in order to have those abductees actually fight an enemy of the Greys, possibly the Blonds, sometime in the near future. We do have abductee testimony that indicates such training but not for those reasons. Most of our sources say the abductees will be taken away before the fighting because they are too valuable (due to cross-breeding projects) to be wasted in that manner. One would not think they would need us to fight for them.

Most Grey abductees are first taken as children. Many adult abductees know or feel their children are being abducted. It would seem that most children who appear to be involved don't want to consider the possibility of actual abduction or think about it all. It would also seem that the best policy with most children is to leave it at that, not push them to remember. Hypnotic regression, especially, is generally considered too much to ask of a child. Even adults, actually should not take lightly the decision to have themselves hypnotically regressed to recall abduction experience. Children and adults alike, if they are involved, will tell you of their weird dreams and experiences even when they don't believe there is anything going on.

Women are frequently abducted largely for reproduction purposes, though some never experience that kind of interaction. Some of those who are involved in that part of it report that their earthbound, human children who live with them, were supposedly allowed by the aliens in exchange for the halfbreed children that are taken away. Often, when a woman is told this, she has only one earth-bound child.

Such abductees who are aware of having produced halfbreed or hybrid children that "live with the aliens" have several different reactions to the situation. Some are perfectly happy with the program as it is, many don't express any opinion about it at all because they don't see it as being anything they can do something about. Some are repulsed by the children and by their own involvement with them. Some have felt that the children we produce will be used against us.

Some of the weapons and aircraft training that abductees are involved in is actually done by the abductee for the sake of the unborn child. Training the mother has received is thought to be transferred psychically to the unborn. Things along this line are part of what might inspire some abductees to fear their halfbreed children.

Others love their halfbreed children as they would any others. Many who feel this way would like to recover their children and bring them back to earth where they would have a better life than with the aliens. Many also feel that the children are better off where they are but would certainly like more open contact with them, more interaction with their children.

OTHER ELEMENTS OF ALIEN CONTROL, INTERACTION AND MANIPULATION

Bio-Field Differential

The biphysical field of the Grey entities is in opposition to the field of the human body. The reaction produced by the interface of the two fields can produce a sensation referred to as "body terror" by Whitley Strieber. A human may or may not experience this reaction, depending on their ability to develop a mental block to the reaction created by the field differential.

The fields emitted by the Greys parallel the type of fields emitted by much of their technology. In fact, the Greys use technology to amplify the effect of their biofields on the human. It allows them greater control over the human, who may react to the field differential with the emotion of fear.

Using Internally Generated Tones to Interfere with Some Kinds of Manipulation

In one case in New Mexico, a woman discovered that if she produced a certain high pitched tone in her head, it would render the manipulative technology inert. She maintained the tone during the presence of the Greys, and even argued with them. Generation of the tone became part of her defense programming.

Awareness Parameters for Tone Maintenance

Since the technology used to manipulate humans encourages relative paralysis of conscious functions, maintenance of tone-interference or other mental techniques must be handled by a form of bridging, or cooperation between conscious and "subconscious" awareness. Effective use of counteracting techniques depends on an increasing awareness of both states. The "subconscious" areas are where all memories are preserved, and all experience there relative to abduction is subject to blocks placed there by both the abductee (as a programmed response to a function which the aliens have connected with the survival impulse) or the aliens. Lucid dreaming indicates a closing of the gap between awareness of both mental areas. Being able to interact with the Greys "on their own turf" is a threat to alien manipulation and control.

Effects of Multiple Level Alien Manipulation

The most interesting aspect of alien control and manipulation is that the technology they use allows the separate and distinct manipulation of both the gross and finer densities that comprise the physicality of the human body. They have the ability to place a human on a table, put him into delta sleep, shock him with a static charge, separate his finer "bodies", and manipulate them at will. Manipulation of finer areas that involve the formative forces of the physical body have tremendous affects at the physical level.

They also have the ability to withdraw experience and memory from a human and place that experience and memory into another body, or "container", whether the container is a natural or synthetic one.

Manipulations of these type have effects on the ability to have one's consciousness leave the body, emotional response patterns and programming, ability to deal with psychic blocks, and a host of other parameters.

To begin to counteract this, work must be done by the individual to work on expansion of awareness. Connections must be developed between the conscious self and the "second self", which may be the self that is projected "astrally". After a while, the conscious maintenance of the connection begins to combine both conscious memories and memories which lie "deeper". Work on self hypnosis and regression techniques with a qualified individual. These techniques will aid in the process of developing more awareness and control. Constant experimentation while in alien presence must be done by the abductee, who must make an effort to note results of various mental manipulations on the alien control effort.

Bio-Conditioning of the Hybrid Fetus in a Human Host

The nature of the alien physiology is quite different from that of the human host. Through the autopsies that have been done on the Greys, it has been found that the tissue is very often a composite that reflects a blending of animal and plant genetics. Some species have black tissue with green blood and appear to function on a light based nutrient system.

Many human hosts have reported mysterious "infections", often yeast-like in nature. Through analysis of many cases, it has been pretty well established that the aliens often purposefully introduce systemic organisms into the human female in order to acclimate the hybrid fetus to the physiological environment of the alien life to come. These substances are thought to be micro-fungi and/or micro viruses. The implantation of these substances is thought to be critical for some species in their hybrid breeding program.

It is quite apparent that there is no concern for long-term affects of hybrid breeding on the human. They apparently make adjustments during the breeding cycle. These adjustments can include injections of substances which physically wear down the human host, as well as manipulation of the various fields inherent with the human body.

The question always seems to arise. If these aliens can produce synthetic tissue, why couldn't they just grow a torso or create a synthetic clone to bear the fetus for them. Why do they have to use human beings for this process?

There are two main parts to the answer. The first one is that they need the genetic input. The whole reason for hybridization is to enrich the genetic capability of the organism. For this they need human genes. The second part of the answer is that they need the effect on the fetus of human emotional and psychic experiences. The hybrid being will develop growing sentience (unlike a synthetic, where the sentience does not extend past that physiologically determined by the matrix - the programming is set) and must be exposed to these factors. One would then ask why they could not sit around and project psychic energy at a clone. The answer is that the emotional component would be missing.

The hybrid fetus is extracted from the human most after about 90 days and development then continues in a totally alien environment.

The whole process causes premature deterioration of the human female host, which simply increases the vulnerability to alien manipulation due to a weakened condition. During the hybrid breeding process, the body of the human female host will be manipulated. There have been cases where fillings in teeth (which may contain mercury and other metals) have been taken out of the human's mouth in order to seemingly promote the health of the developing fetus.

**Some Major Indicators of Alien Interaction
and Possible Hidden Involvement**

- A. Missing Time**
- B. Waking up during the night or in the morning with unusual bodily sensations, such as tingling, numbness, dizziness, heaviness, or paralysis. Any of these are often accompanied by disorientation.**
- C. Nightmares or vivid dreams of aliens and/or their technology.**
- D. Sleep disorders. Also waking up consistently at a specific time.**
- E. Physical marks or evidence of bodily manipulation.**
- F. Repeated sightings of alien craft.**
- G. Clear remembrance of alien contact and interaction.**
- H. Healing or inexplicable improvement in physical condition.**
- I. Reactions of fear, anxiety or unusual bodily sensations upon viewing visual images of aliens or their technology.**
- J. Feelings of having had a communication.**
- K. Unexplained behavior totally inconsistent with previous patterns.**

Any or all of the above indicators may appear in combination with other ones. Many of the indicators could also signal a physical problem requiring medical attention.

Clinical psychologists in 1989 have reported that a significant number of people have been helped by their interaction with alien species, mostly through alien physical manipulation that resolves a physical condition.

ABDUCTION-RELATED MEDICAL ANOMALIES

Abnormal blood cells

Inplants - eye, skin, nose, anus

Diarrhea - men

Constipation - women

Shoulder pain that comes and goes

Lower back pain - 3 vertabrae up - lower lumbar

Knee pain - in dip of knee under knee cap

Rashes (immediately after contact) - may be caused by radiation

Lump in dip of collar bone at connection to neck

May cause paralysis of arm (Do not know why; only that it exists)

Artery in the wrong place - implant in arteries

Pregnancy connected with abduction time period - unusually small fetus

Baby has unusual appearance

Child has ESP and is advanced beyond years

Eyelid may contract and roll outwards under stress

Eyes may be able to see through closed eyelids

Marks on body

Scars in geometric form on body

Scar on back of leg for people born in 1943

Seems to indicate skin scraping, i.e., cloning

Buzz - beep - or modulated tones in ear when going to sleep

Last breath feeling - may be out of body experience

Shaking of bed in conjunction with limbs of body floating or rising

Geometric symbols seen in mind.

Tiredness in morning after sleeping all night. Feel as though you are worn out -
sleep learning

Out of body experiences

Sudden development of ESP

Wry neck - enzyme to brain - new development

Extra vertabrae in neck

Egg sized lump on bottom rib - doctors say nothing is there when examined -
why do contacts have it?

Worts form a geometric shape after examination - appears to be from some
instrument

PHYSICAL LOCATIONS OF ABDUCTION RELATED BODILY INJURIES

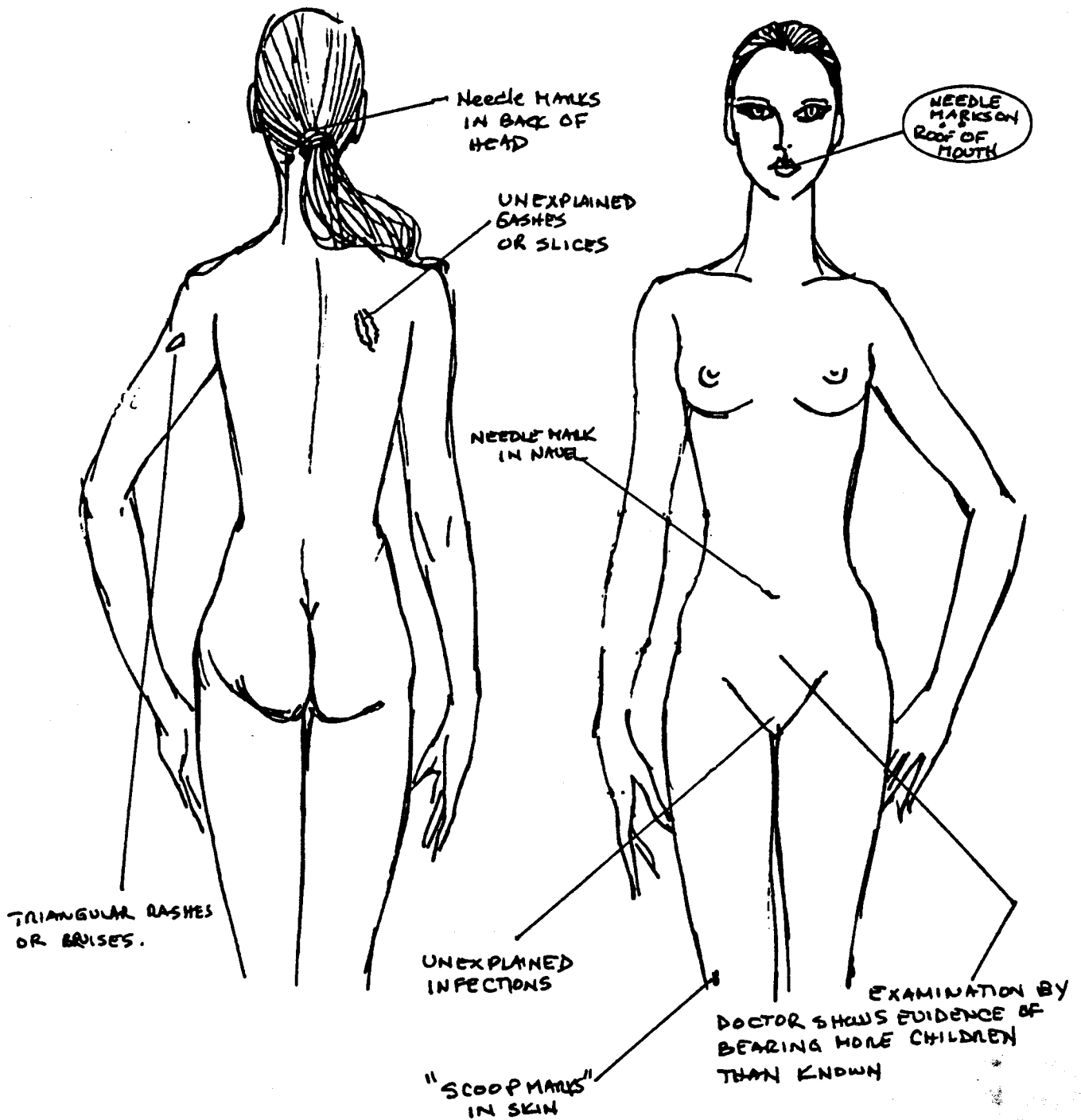

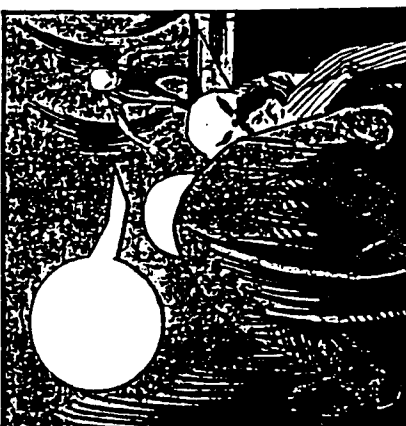
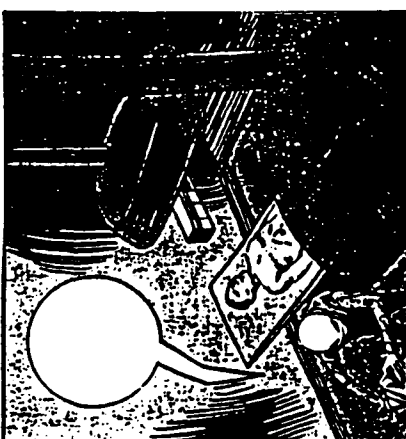
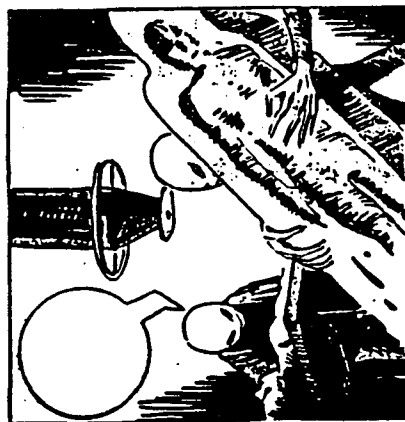
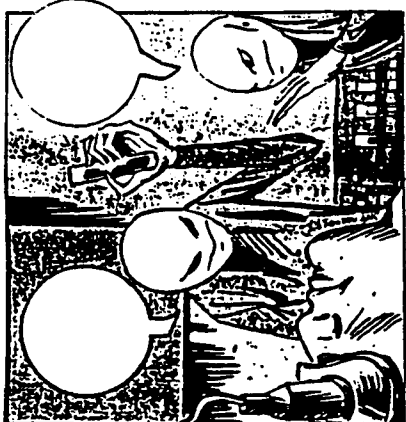
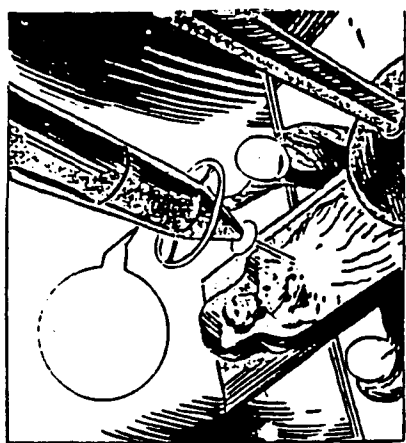

THE ABDUCTION OF CHRISTA TILTON

THE TRIAD EXPERIMENT by Christa Tilton (All rights reserved)

My first abduction, which occurred in 1962 when I was ten was not nearly as traumatic as I look back on it now. I was examined and tagged with an implanted device of some kind. The device was placed in my left ear, which causes alot of pain and severe itching at times. My daughter has the exact same problem today. The aliens were able to transmit communications which were introduced by a kind of "ringing" or "beeping" sound that I still hear today. I remember that "The Doctor" was more human-like and alot nicer. He told me that they were going to play a little game with me called "planting a garden". At that time, I was sure he meant going out to plant a garden in my back yard! But, that was not the case. A small device was implanted in my abdomen. I was shown a 3-dimensional screen with symbols on it. All in all it was not traumatizing to me in the least.

I was abducted again in September of 1971. I remember seeing the same beings as before. They inserted a long needle from a long tube from the ceiling instrument panel. I was fairly sure they were extracting ovum. They examined and changed something in my left ear and then they placed a transparent capsule-like device into the area in my abdomen. When they withdrew the instrument the capsule was gone. After this examination I became pregnant, although, I had had NO SEX in eight months. I was never aware at that time that I was pregnant until I aborted the fetus. I was rushed to a New Orleans hospital and the doctor examined me and said he was sorry but I had miscarried and had been atleast 12-14 weeks along! I had had some "missing" time several days before the bleeding started now that I look back.

I was abducted again on February 4, 1976. The craft and beings, the same. This time I was prepared and artificially inseminated with what the ETs said was a genetically purified, fertilized ovum. I had been totally inactive sexually for many months. I delivered a healthy baby girl, although I had severe complications with the delivery so a Cesarian Section was performed. My daughter now is exhibiting signs of having already been abducted at ten years of age. She is twelve now and has unusual characteristics. She has had numerous UFO sightings around our home and even told me of an experience she had while on board a spacecraft! I was shocked because I have never told her of my experiences nor has she ever been interested in UFO books or TV shows. She has an exceptionally high IQ and is on the Honor Roll every year. Also she is a cheerleader in her junior high school and shows exceptional abilities in piano and voice. She is a fan of all operas and has appeared in many on the stage. She made her professional debut in a movie that was being filmed in my home town and also has been a model. She has severe panic attacks if any Doctor wants to look into her left ear. She has experienced this unusual fear for many years. She is a very serious child. One day she came into my room and shut the door and at that time (10) she had molded a little alien in clay and set it on my dresser. Completely in shock, I asked why she had made this and her reply was simply, "Mom, don't you know I am not from here!" So it is not just ourselves that we need to be concerned with...it is our children. They could very well be STAR CHILDREN!

My full story will be told in extensive detail in a new book titled "UFO ABDUCTIONS OF WOMEN-THE TRIAD EXPERIMENT which is now in development by UFO PHOTO ARCHIVES. There is much more to come in the next issue of CRUX #6, which is in the works now. © Christa Tilton

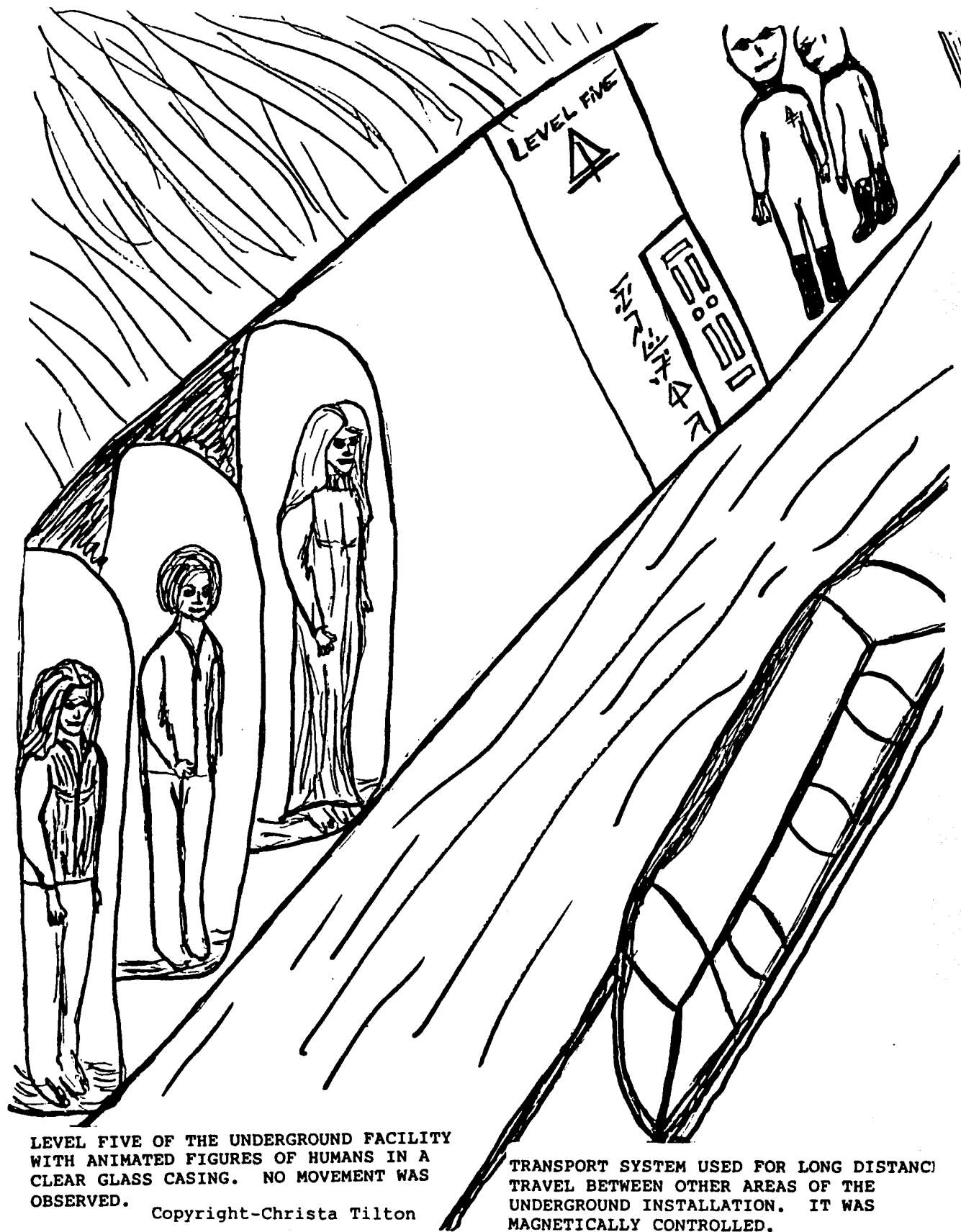

LEVEL FIVE OF THE UNDERGROUND FACILITY WITH ANIMATED FIGURES OF HUMANS IN A CLEAR GLASS CASING. NO MOVEMENT WAS OBSERVED. Copyright-Christa Tilton

TRANSPORT SYSTEM USED FOR LONG DISTANCE TRAVEL BETWEEN OTHER AREAS OF THE UNDERGROUND INSTALLATION. IT WAS MAGNETICALLY CONTROLLED.

A CASE SIMILAR TO THE TILTON CASE

It matters not to whom these experiences happen. What does matter is that they do happen! For those that are skeptical, that skepticism will remain until they have had their own experiences. Or he who is convinced against his will is of the same opinion still. Therefore I am not trying to convince anyone. I am simply sharing my experiences with whoever is interested. What I convey here I know to be true, although I leave the belief factor up to the individual.

On the morning of October 12, 1980 at approximately 3:30 A.M., I received a call from a man who had a well-publicized sighting in the area. I had gone to talk with him earlier about his sighting. The call went something like this: "Donavon, there is a strange light in the sky headed your way. It's about out of sight from my point of view. Would you mind going outside to see if you can see it?". I assured him that I would, hung up the phone, wiped the sleep from my eyes, got dressed and went outside. After a few minutes I spotted the object headed my way. At this point it was rather small and difficult to see through the trees. So I decided to get in the car and drive to a better location. I kept my eyes on the object so much that I drove off the road a couple of times. As the object got closer it also got bigger. I had reached the intersection of the road I was traveling on and a highway. So I stopped the car and got out and watched the object as it came closer, until it stopped right across the highway in front of me. There it was - a brilliant white light the size of a grapefruit, just hanging there in the eastern sky. I was totally mesmerized with a feeling of warm security which words cannot convey. There was this feeling of an electric charge or tingling sensation, which flowed in waves from the top of my head throughout my body to the tips of my fingers and toes. It was as though time stood still; there was no perception of time. As I watched the object, I noticed a very small white light that blinked constantly. The blinking light was very close to the larger light but I couldn't tell if they were attached or not - it was very dramatic. It was then that I spotted two more objects out of the corner of my right eye. They were smaller and revolved with red and white lights and made erratic movements, sort of like a penny falling down. One flew from my right to the top of the larger object, the other to the bottom, simultaneously. They both lined up with the larger object in a vertical fashion. It appeared that they were being drawn to the larger light. There was absolutely no sound coming from any of them! The two smaller objects remained in that position for about fifteen to thirty seconds, then they flew off to the northeast. It was then that I finally came to my senses and thought to myself: "Stupid, go back to the house and get your camera". By the time I returned the larger light was also gone.

In February of 1980 this incident took place. My wife was in a town about seven miles from where we lived. She was approached by a man on the street. The following conversation ensued:

Stranger: "You are married to Donavon Masters, aren't you?"

Wife: "Yes."

Stranger: "Has he ever told you of his belief that he is a being from another planet or world?"

Wife: "Yes, as a matter of fact, he has. How did you know?"

Stranger: "That is of no consequence. You think he is crazy, don't you?"

Wife: "Well, maybe not crazy but perhaps he has a screw loose."

He went on to tell her many things about myself that only I would know! As for the belief that I am from another planet - until now I have only told that to my mother and wife, for fear of ridicule. Well, the last statement the stranger made was this:

"Your husband is not crazy. In fact, he is of the superior intelligence of this planet. Although most of the beings of your world cannot comprehend nor understand such intelligence. Because of the standards they have set for themselves. Please tell him that when the time is right, he will know everything."

With that statement, the stranger turned and walked away, leaving my wife very perplexed. I nor my wife have ever seen him since. When she came home and told me about the events of the day - needless to say I was amazed! I had mixed feelings. On the one hand I was asking myself - who is this mysterious stranger? On the other hand, I really felt good about the confirmation of a belief I had all my life.

The following is what I believe to be a very real experience, which I believe ties into the experiences of Christa Tilton. Three of my friends and I were taken to what I perceived to be an underground government facility or UFO base. I say "friends" because that is how I perceived them, although I had not met them at the time. I remember feeling as though I had been drugged, as if everything was kind of going in slow motion. We were placed on and strapped to a conveyor belt by our wrists and ankles. The conveyor was activated and as it began to move our bodies were passed through blocks of pure intense light. These blocks of light - perhaps laser scanning devices - were either green or blue in color. At each block of light there was what I perceived to be a robot controller. They also were either green or blue in color. Their color corresponded to the color of the light in front of which they stood. The robots were in human form but with no distinguishable human characteristics. Along the wall in the first room were barrels of some substance which had a very pungent odor. These barrels were stacked, one on top of the other.

Suddenly we were on a different conveyor belt or at the end of the first one. As the belt moved around a circular console, it stopped. There were two men - human in form and characteristics - seated at the console. One assisted the other. One of them picked up what I thought was a razor and shaved an area on my back left side just below the waist line. I remember that the spot bled considerably. I was released and they began to do the same procedure on my friends. I remember thinking over and over - "What is happening to me?" Upon being released, I remember asking a black man standing there: "What is happening to me?" He replied, "You have just been implanted with your government control extension number". I remember grabbing a mirror and looking at the area that bled. The number "04" was there. In a very upset manner I turned to a woman in a uniform and exclaimed, "You can't do this to me!" Incidentally, all of the personnel in this facility wore uniforms. I then ran back to the console where I was released. By that time my friends had also been released. I hurriedly told them what I had discovered was happening to us. As I was speaking, the two men at the console were gathering materials hurriedly, in what seemed like an attempt to escape. In particular I remember the man that had implanted the number on me had a computer print-out list. He protected this list with his life, as my friends and I ran after him and the other man. They escaped through a set of double doors. I sincerely believe that Christa Tilton was also in this facility at that time - although I don't think this was our first meeting.

I will never forget the first time I talked with Christa on the phone. It was September 20, 1987. I felt as though I was hearing the voice of an old friend, as though I had known her all my life. She later sent me a picture of herself which only solidified that feeling. When I saw that picture I had flashbacks of seeing her aboard a craft! It was a very emotional moment for me, seeing her again. Since that time a beautiful and enduring friendship of unconditional love has developed. She is truly a flower in the garden of my life and a true friend. Like Christa, I have been plagued by intense, repetitive dreams of meetings and communications with what appear to be non-human, other-worldly beings. I am also continually frustrated by my inability to learn the truth about my experiences, although Christa has been a

tremendous help in my search for the truth - proving that when people work together for a common goal, much is accomplished. Like her, I suffer from insomnia, and the fear of what might happen if I fall asleep. I believe that I have been abducted countless times astrally, and one of these times I saw Christa aboard a craft. I remember walking around a circular corridor, just sort of checking things out unattended when I came upon an open door. I walked just inside the door and saw her lying on what seemed to be an examination table. She was surrounded by light grey alien beings, 3½ to 4 feet tall. They were wearing what looked like close-fitting coveralls, almost like a second skin. I was then telepathically told that I was not supposed to be in that area or to see or be in contact with her. I was not only asked to leave but also escorted out of the room and down the corridor. At that time everything gothazy and I guess I blacked out, because that is all I can recall.

I believe that the grey aliens are perhaps a cross between biological and superior electronics or cyborgs. As for the human-looking aliens, I believe that we are direct descendants of them, seeded here on planet Terra hundreds of thousands of years ago by our space brothers. These two passages from the Bible are called to mind at this point: Genesis, chapter 6, verse 2: "That the sons of God saw the daughters of men that they were fair; and they took them wives of all which they chose". Also, verse 4: "There were giants in the earth in those days; and also after that, when the sons of God came in unto the daughters of men, and they bare children to them, the same became mighty men which were of old, men of reknown". Some very thought-provoking scriptures to say the least, huh? I not only believe that these passages are the very crux of the abduction experience, but also a very real explanation for the reason for Christa's abductions. I also believe that thousands of abductees have very important parts in the ushering in of the "Golden Age of the Millennium" or the "Age of Reason". These are spiritual teachings taught to me by our space brothers in a higher dimension of reality. Although Christa and myself are not alone, I suggest that there are thousands out there like ourselves, perhaps afraid to seek out help and a better understanding of their experiences because of the fear of ridicule. It is a truth that sometimes life can be very cruel because of the ignorance or lack of knowledge concerning this vast, exotic subject. Then maybe some, like the ostrich, stick their heads in the sand because they are afraid to question their own fates.

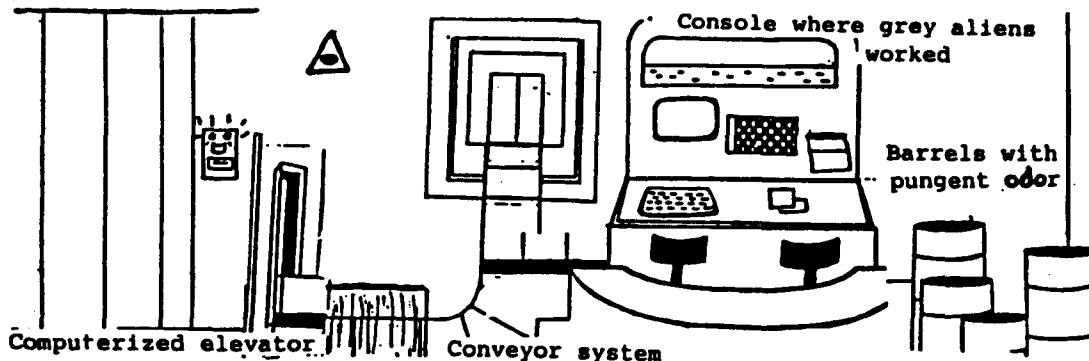

SIMILARITIES BETWEEN THE TILTON CASE AND THE SECOND CASE

33. In both cases a winged serpent was the emblem in a background shield.
34. In both cases the suit continued up over the head with an opening only for the face.
35. The headcovering hood had something like earmuffs on the sides.
36. In both cases the ETs spoke both audibly and mentally.
37. The audible voice sounded strangely mechanical and synthetic.
38. In both cases the ETs used language translating computers.
39. Both abductees were given information about the ET's ship's power and propulsion and control systems.
40. Both abductees experienced the "crawling" sensation under their skin and paralysis.
41. In both cases the ETs were conducting genetic experiments on humans.
42. They both were carrying out experimental breeding programs on us.
43. In both cases the ETs were especially interested in controlling the abductee's brain and brain chemistry.
44. In both cases the ETs have demonstrated control of the abductee's brain.
45. In both cases the abductees were unable to resist the control.
46. In both cases the ETs were able to block the release of certain information by the abductees, even under hypnosis.
47. In both cases a winged serpent was seen in the insignia worn on the breast of the ET suit.
48. In both cases the winged serpent emblem was superimposed on a shield-shaped background.
49. In both cases the ET craft was a biconvex lenticular form.
50. In both cases the ET craft extended cylindrical tripod landing legs from the bottom of the craft and landed on them.
51. In both cases entry was through a rectangular hatch about midway between the bottom center and the outer rim of the craft.
52. In both cases a man came out of the ship and walked over to the abductee's car. Both cars were stopped by the ETs.
53. On both ships the blinking lights around the rim of the craft stopped as soon as the landing ship was on the ground.
54. When the lights stopped blinking and dimmed it signified that the ET craft was on the ground.
55. All the lights blinking dimmed out when the ship was on the ground.
56. Both domes of both craft were full curved equal sections of the arc of a circle.

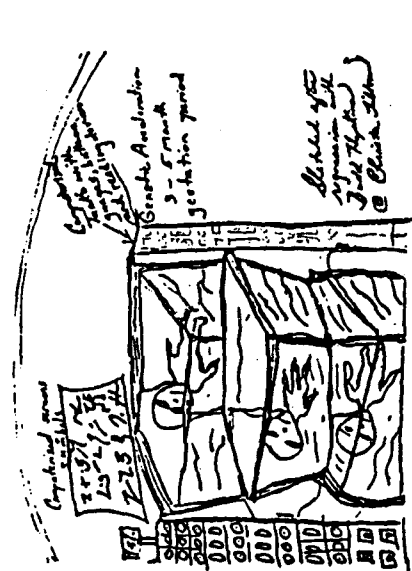

CONSCIOUS CONTACT

Another Case in Las Vegas

In February 1990, a strange and interesting series of events began with two individuals in Las Vegas. The events began with one of them, Roger, and eventually included his friend Pete. Roger recalls the events in the beginning in his own words:

" It was 5:06 pm on February 15th. I awoke with the feeling that I was not alone in my bedroom. I looked around casually and saw nothing, so I laid back down to go back to sleep. The moment I closed my eyes, I saw a door with a window and what seemed to be blackout curtains covering the window. The curtains parted and as I looked through the window I saw two men dressed in formal attire. I heard them discussing an assassination of some kind. After a short time, the curtains closed. When the bottom of the two sides of the curtains touched, an intense energy manifested itself within me. This energy seemed to begin with a vibration, and accompanying the vibration was a brilliant light. The light, sound and vibration surged through my whole body. I thought that the light was so bright that if I were to open my eyes, I thought that it must surely illuminate the entire block of houses. When the energy flow subsided, it was very dark and very still. I called my friend Pete and told him what happened. He said he'd come over.

I own three Japanese Akita dogs, and I noticed that they began to whine and bark. Pete arrived, and we both shared the feeling that we were not alone. We went outside and looked around and noticed that there was only one cloud in the sky, and that it was right over my house. We returned inside to discuss the strange situation, and we still noted that we felt like we were not alone. The dogs became silent, and Pete said that if we looked outside the cloud over the house would probably be gone.

We looked outside, and the cloud was gone. The next day, after sleeping with some difficulty, I awoke again at 5:06pm with the same feeling that I was not alone. I looked around and saw nothing. I went back to sleep and woke up at 6:30pm and went to work.

On the third day, February 17th, I awoke at 1:00pm and realized that I was paralyzed and could not move or speak. I then felt something probing in my right ear. It became increasingly more painful. Knowing that I couldn't speak, I decided to try and communicate with my mind to whomever might be doing this to me. I commanded them to stop, and to my surprise the probing and the pain stopped. I could then move, but after all this I couldn't go back to sleep.

On February 18th, I had a good night's sleep. I met Pete at work and he said that he had been awakened about 3:00am and realized that he was paralyzed. Pete said that he summoned all his willpower and was able to break the paralysis, only to have it start again. This process continued for about two hours until about 5:00am. Pete was very angry with this interference in his life. Little did he know that this was only the beginning.

On February 19th, I came home from work and lay down and noticed after a few minutes that I seemed to be in a sort of semi-trance state. The only light in the room was a single candle. Somehow I got it into my head that I could control the flickering of the flame with my mind. I tried it, and I found that I could actually do it. After finally falling asleep, I woke up in the morning and got it into my head that I could control my dogs with mental commands. To my surprise, that also worked. I decided to meet Pete at work and told him about these strange events. That is when he told me that he had actually seen the aliens for the first time.

Pete said that he was lying face down sleeping when he felt a hand on his left side. He thought it was his son. A gust of air hit the side of his face. At that point, Pete said he turned over and saw two alien beings. One was standing erect in a doorway while another crouched below. At the same moment Pete noticed them, the one that was crouching hopped into the bathroom in what seemed to be a pitiful effort to avoid its detection, swinging its arms side to side like a monkey. The appearance of the aliens was that they were about four to five feet in height, weighed about 140 pounds, black skin, beige-colored circles around black silver-dollar shaped eyes, a beige snout and hands with four fingers and an opposing thumb. The feet were also beige colored. Pete and I discussed the aliens, and we could not rule out the possibility that they might have been wearing some sort of coveralls.

From the beginning, I had it in my mind that the only way to deal with these beings was in a non-physical manner. I began reading Robert Monro's "Journey's Out of the Body" for some answers. The next two days were uneventful. I felt like they were giving me time to read the book.

On the ninth day, the vibrations began again as I began to fall asleep. They seemed to pulse, taking about 5 seconds to move from one end of my body to the other and 5 seconds to move back again. They increased to a point where I was separated from my body, and I found myself hovering near the ceiling for a few seconds. Out of panic, I shot back into my body only to discover that the vibrations were pulsing through my body faster than ever. I sat up purposely about four times and managed to drive the vibrations away. After

reaching work that night, I saw Pete. He told me that he had seen the aliens again. He was awakened at 3:05am once again, and was not able to move or speak. The aliens were in the same position, and watched as Pete struggled to free himself from the paralysis. It seemed to Pete that only a minute went by, but when he looked at the clock again it read 3:50am. At one point, Pete managed to free himself and began to yell at the aliens, who vanished right in front of his eyes.

Several days passed, and we began noticing that electronic devices around both of our houses began to behave in strange ways. Timers would run backwards and things would move around the house. Pounding and twanging sounds came from the attic.

On the eleventh night, I awoke with my mind filled with light, colors, pictures and symbols. This went on for about two hours, and I contacted friends at Nevada Aerial Research, who stated that it might be my translation of a mathematical language.

Pete called to tell me that the beings had appeared when he and his girlfriend were making love. They just sat there and watched. When his girlfriend saw them, they turned and ran down the hallway. Pete and his girlfriend ran after them down the hallway and into the living room where they winked out in front of them without a trace. The next morning while Pete was getting dressed, he glanced down the hallway in time to see one of the beings step out of thin air and wave to him.

A month or so later, I discovered that my answering machine had recorded 20 minutes of my own conversation before I went to work. It will now play no other message, and is completely useless to me. I took it to a repairman, and he said that it was impossible for the machine to be what it was doing.

I have come to the realization that my very thoughts and actions are being monitored - it seems that my very thoughts are reflected in the strange things that are happening.

Pete said he had this experience: he was flown off in a ship where there were hundreds of humans. The stars were whizzing by just like on Star Trek in warp speed. He said there were large three-foot *rabbits there that had human faces*. Everyone seemed to be having a good time. Pete found that he had IV in his hand, and presumed that it was administering some kind of tranquilizing substance into his system. When he awoke, Pete noted the puncture mark from the IV in his hand.

On the ship, Pete said there were three seven-foot Greys that were sitting in chairs. When he awoke in the morning, Pete saw three beings laying down in the hallway. Two were on their stomachs and one was laying on its side. They were all holding

Properties of Dematerialized Matter

- (1) Matter which has been dematerialized has little or no inertial properties.
- (2) The atoms and fundamental particles of the dematerialized matter can no longer generate a magnetic field when given velocity.
- (3) The electromagnetic effects of the fundamental particles have vanished.
- (4) The particles are rendered motionless.
- (5) Higher frequency matter of the *etheric matrix* is responsible for maintaining correct spatial relationship within the matter.
- (6) The etheric double of the physical body cannot generate a magnetic field during the teleportation process. It too is frozen and dematerialized

Principles of Matter Dematerialization and Materialization

- (1) Dematerialization takes place when matter is impregnated with the correct combination of soft electrons.
- (2) Dematerializing energies consist of soft and harder electrons comprised of photons from the ultraviolet to near the gamma range.
- (3) Dematerialized objects can be pushed along by a beam of light.
- (4) When the object reaches its destination, it is impregnated with materializing energies of soft electrons composed of photons of a lower frequency.
- (5) Ultraviolet light of the correct frequency will drive out the soft electrons which make matter visible. These energies must be supplied continuously in order to maintain the effect.

The Government Factor

by

Cynthia Crowell

(c) 1990 NAR

A significant part of the abduction experience is the government factor; both for abductees who are not directly involved with it as well as for those of us who are. I can only speak in terms of being an abductee in the United States, but I am know that it is done in the same way world wide.

In the 1960's, the American government knew about the situation with abductees; it has the appearance of implicit agreement with aliens involved as well as with government manipulation of people and their use of screen memory and mind control techniques in order to replace the memory of government involvement with a memory of something else. Both this process and alien interaction are occurring.

In the 1960's, the government assigned "agent-handlers" to monitor individuals having alien interaction. These people would assigned to monitor both children and adults. There is some evidence to suggest that families in government employ were prime targets. These handlers appeared to be every bit as human as the people they were monitoring.

In some cases these agents conducted their own abduction of individuals in order to monitor, interrogate or perform memory erasure techniques on them. They erased our memories, just as the aliens have done.

My own experience with this program started when I was about seven years old. I had been abducted by the Greys and subjected to some kind of procedure. After they had left the room, humans in khaki colored uniforms began coming into the room. One of them gave me a hard time while I was laying on the table and another one came in and ushered the first one out. This was done purposely, to provide a bond between me and the agent. I guess I was supposed to look on him as someone to trust. It probably worked. As my family traveled around the country, which took over a year, I ran into this man three times.

The point is that there were no aliens involved in the event with the humans. The entire situation was created by the government factor and I think those kind of situations are more the rule than the exception.

Abductees are under government (NRO/NSA/CIA,etc) surveillance because of alien contact. This government mind-set demands that we suddenly have no rights or values beyond our obvious value of keeping track of what the various alien groups are doing.

Further, the situation seems to be one in which parts of the United States population are seen by certain factions within the government as a threat to "national security". This may be behind the spiteful attitude with which people are being treated, especially by military based factions of the government. Assuming the government had made a deal that they regretted in a later administration, they would be faced with millions of people that have had contact with other beings. The agent-handler program was intended to track and monitor a percentage of the people having alien contact in the hope of being able to predict possible use of humans against covert factions in the government and to defend the concept of "national security".

It would not surprise me to learn that the government is aware of the group-mind aspect of the abduction experience. If so, they would know that the more abductees they can counter-control, the more influence they can exert over people who have contact with other beings. If they are not fully aware of and acting on this aspect, then it may mean that we are not only expendable but have already been lost to the conflict as far as the "secret government" is concerned.

The government does have some implant technology, although they may be hampered in the use of it by previous alien implantation or other actions. Since the government has a better understanding of human psychology than some of the alien groups, it is far less desirable and appropriate for the government to be able to freely manipulate the populace than it may be as far as the aliens are concerned. There is some evidence that the government has created abductees that function as "double-agents" themselves - evidence in these areas is starting to become apparent.

I recall being told not to talk about these subjects (but not specifically by whom) and I am aware of a threat that I can't quite put my finger on yet. This impression of a threat is strongest where the subject of aliens is involved. Most of the time I have assumed that the threat did not represent a true danger, but since that time I have become conscious of government involvement. Which side has more to lose to exposure? Which one considers me a threat? Both?

I can understand the concept of the government running into an alien technology and making a deal to buy time in order to try and deal with a perceived threat; at what point did they become "monsters" who run drugs and guns to finance their actions, abuse children and suppress technical developments that would help us overcome a lot of grief?

We "abductees" are the human sacrifice of our times. This would probably be acceptable to the vast majority of us if we could believe that it was for the good of the whole. If asked and treated decently and with dignity, a lot of people would go out of their way to assist any species. Humans have been sold out. I could be your mother or

sister. And there probably are abductees in your family, friends or acquaintances, no matter who you are. But our blood has bought you nothing (like medical, technological and other scientific advancement) and it has not saved you or your children from the aliens. It has served only to line the pockets of the select few in the central power group, be they government, financial, religious and/or alien leaders.

If this system is not successfully opposed, what will happen to you if the Greys really do take us (abductees) away? Who will that central power group feed on, when we, the abductees, are all used up? Themselves?

Soul-Shearing

The second phase of "adult" abductee interaction is what I will refer to as "soul-shearing". The description is probably inaccurate, but that is what it feels like. I have been told that we all occupy several different "bodies" all stacked together like nesting boxes - the physical body surrounded by the etheric "body" surrounded by the astral "body" surrounded by the mental "body", etc.

We also actually have an extra "body", the emotional "body", that the aliens don't have. This part of us constantly puts out a kind of energy they can not generate or simulate. This emotional energy (which you are aware of as love, hate, etc., - it is really all the same kind of energy at different angles and intensities) is, to them, like a potent, much sought-after drug. They can take it out of us and bottle it, so to speak, and use it recreationally, scientifically and as a trade item, like money. We constantly generate this energy, storing it within one of our many "bodies", always keeping a supply "on us." I've been told that it is stored in our etheric body, as a substance, between the small ridges of the etheric field. This energy is also contained within our experiences and memories of experience.

Sometimes, the memory of experience is taken with the energy that contains it. This is why some abductees may experience memory loss of experiences that seem to have nothing to do with abduction. It is interesting to note that once an experience is had and the memory of it created, this memory goes into storage that is consciously available to us and also, like a mirror image, into this etheric field. If it is moved from our conscious minds, it is still stored in the etheric, usually retrievable by regression or other means. However, if it is removed from the etheric, it also disappears from the storage available to consciousness. Memory lost in this way can not necessarily be regained through hypnotic regression. It feels as if the experience itself has literally been snatched out of the past with this kind of memory loss. The Greys will say that has occurred.

But even in these cases, diligent pursuit of the past will lead the abductee to a form of the Akashic record under deep hypnosis, sometimes, where a record of events can be found, though it will not be a genuine memory. This record of events is more like a movie scene than a memory of something that actually happened to the observer.

During the process of "soul-shearing", it feels more like something is being taken from within as opposed to from outside the physical body. I know this because we are left conscious for the process; consciousness intensifies the product. Also during this "harvesting", Greys will look directly into our eyes, as if they are drinking something or basking in light. This may be why their eyes strike us as so ugly. They're not really ugly, just big, but when we see them, we subconsciously associate them with the horrible feelings of the harvesting. Abductees will say about Grey eyes, "They seem to look into my very soul." I have always considered that description to be basically backwards. The sight or the memory of the sight of Grey eyes brings on a feeling that they are "sucking my soul out of me" (absorbing it into themselves), not looking into my soul. It feels like you are disappearing from existence.

The "soul-shearing" is not only a harvesting, but one of their control mechanisms. After a harvesting, depending on "how much they took", we may go through intense emotional activity such as depression or anger, over producing the energy as fast as possible to "restock our storage." This can leave us exhausted with no apparent cure but time.

With the process of "soul-shearing" or one like it, they can literally take a person (let's say Billy) out of his body and put him in another person's (let's say Bob's) body. The essence of Billy's conscious awareness and identity, motivations, values, etc., can be put into Bob's body. Bob's essence can be put into storage (something like freezing) while Billy occupies his body. They can separate it further: Billy's essence can be spliced into Bob's body and conscious programming and memory. In other words, Billy could be taken out of his life and body and put into Bob's life and body, and never really even know the difference, except for strange dreams and feelings he could not associate with resident "Bob" memory and programming. I have been threatened with this and would not be surprised to find out it has already happened. I suspect this is done on a regular basis. They do it partly to keep us confused. It is a super-blocking or double-blocking process as far as memory. Beyond experience/memory removal, it is a massive experience/memory replacement.

Many times, I have experienced time as or through another individual, often in other time frames and in other, alien cultures. For a flash of a moment or for several moments at once, I will actually be another person. This is done when they manipulate and temporarily separate our various bodies. They take the part of us that us that is consciously aware into their own group awareness, through which we can experience as another person who has also been taken into the group awareness via implant or whatever other means they may use. I do not know their reasons for doing this yet.

Kristie Bjork
Dallas, Texas
7 October 1989

Nevada Aerial Research Group
P.O. Box 81407
Las Vegas, Nevada 89180

To Whom It May Concern,

I am an abductee. I am a contactee. I am a UFO researcher. All of these and more. I have had missing time several times. I love to write. I have been involved directly in the government coverup. I have weird scars on my body in the navel, ovarian canal, and spine.

These scars were not noticed until recently - this year. I have never been to a hospital for surgery.

All this is fascinating. I'm an unusual abductee. I'm not terrified of UFOs and aliens. I'm NOT in love with the idea of entities coming into my bedroom at 3am, waking me up and staring at me with big, fat eyes. I'm usually maneuvered into a situation where I am alone out in the woods or simply "beamed up" while asleep. I have conscious memories of contacts made at about age 4 or 5. One was an underground base with vats, no less.

The vats had cattle body parts in them. The "people" doing the abductions are two kinds. One is blond with long hair. The other is small, grey and delicate. The entities drawn during the Travis Walton case are identical. These "people" have done a lot of weird things.

Once while in college I got a strange letter about me being "mate-able" material, and a drawing of a serpent symbol. The aliens have a serpent symbol. I did not know about Travis Walton when my experience happened in 1970.

I had loads of sightings. I guess I must have lived near a base of some kind. The usual balls of light, saucer shapes, and ovals in formation.

I do not get premonitions of abductions - they just seem to happen out of the blue. Since I've moved to Dallas, I have only seen one UFO in one year. I've seen UFOs in Garland, Texas and in Irving, Texas.

I have a girlfriend who is researching UFOs. She joined the Air Force in 1980. I got into the Navy but was discharged due to my asthma. She called me and told me some information that got us both investigated by the FBI. They were tough on her. She nearly committed suicide. They threatened me with the espionage laws. They pumped me for all the data I know on UFOs.

The upshot is that they were so upset over us finding out that these three UFOs landed near an airport near Moscow. UFOs were also detected entering the solar system from outer space. I believe that there is data that supports the Extraterrestrial Hypothesis, which involves trans-dimensional technology. There is a definite psi factor involved.

The aliens utilize light to do a lot of things. One way not mentioned often is to force feed the brain with information and programming. The Greys can somehow drain the brain of memories. This gives rise to the idea of "soul suckers".

Sincerely, Kris

Channels As Contactees

There is a large and growing number of channels in our society today. It seems that any kind of information can be channeled. As with most other sources of information, this source can produce any kind of information from completely useless babble to apparently supreme or advanced knowledge, in some cases.

Most channels are said to be channeling another expression of themselves, either themselves in the future or the past. Some claim to be used as a living communications device between humans and aliens, and not otherwise connected with the aliens.

There are various sources of channeled information - the information received in this way must be judged for itself.

Research indicates that many abductees, as well as contactees, are able to channel, whether they do very much of it or not. Greys have put out through channels, some extremely high-level technical information, but they seem totally unable to work with human emotions and belief systems and often fail to maintain a good working relationship with the channel.

Channeled material, both from Blondes and Greys, is presented elsewhere in this book for consideration.

Walk-ins

A "walk-in" may be defined as someone who occupies a body they have not occupied since its birth. In other words, a person was born into a body, but later vacated that body and allowed another personality to literally walk into the body and take over control of the body and life of the original person.

The Greys are said to have the ability to remove a person from his body and place him in someone else's body, and, by removing conscious memory of the first life, convince the transplanted personality that he or she is the person of the second body. When conscious original memory of identity is removed, it is replaced (the person is "re-programmed" consciously) with the memory and identity of the person who originally occupied the second body. Supposedly, when this happens to a person, their only indications are that they feel out of place in their own environments, they have dreams and strange feelings about being someone else, etc. Though the possibility of this kind of situation has come up several times in our research, we have not yet been able to study it in depth.

Most walk-ins supposedly know that they are such, if not who they really are and what they are doing here. There have been some cases when aliens temporarily took over a human's body in order to perform some job. The human identity and consciousness are somehow put on ice during this temporary occupation, as if unconscious, even for years at a time.

The case of Adrian is a case in which the consciousness of a Grey was transplanted into a human child. Whether the Grey personality replaced that of the child or they were merged together is not clear. We do know that many Grey abductees have experienced a merging of consciousness with the aliens and with other people, though it is usually for short periods of time.



Awareness and Choice

The aliens that are using humans for breeding purposes seem to exist in a state slightly ahead of the humans in time, and this seems to allow them to stay slightly ahead of the abductee in terms of predicting what choices the human will make.

One way to confound the abilities of the aliens to do this is to embark on a program of expanding your awareness and your self-empowerment. Work on psychic development in a growth oriented way.

When you expand your involvement in life, your choices and thoughts about what you are going to do also increase, which makes it that much harder for the abductors to predict with certainty what you will do in any given situation. Expanding your awareness also aids your efforts to deal with them on their "own turf", which is to their disadvantage.

Changing awareness also changes your identity and your ability to deal with events in a more flexible manner. Adopting a pen-name and writing about your experience and development fosters this process of interfering with alien predictive ability.



Anonymous Letter describes Alien Activity

To You, whom it DOES concern,

The unholy alliance in effect between the worldwide military-industrial complex which controls all major governments on this planet and alien beings from a neighboring planet in this solar system is slowly being exposed by a small group of ordinary people who found themselves in possession of extraordinary information. These Patriots have managed to uncover some of the generalities of the "treaty", but the ultimate purpose of it remains well guarded by those who are the beneficiaries of this devil's pact. It is my fear that by the time the whole truth comes to light through the efforts of these Patriots, it will be too late for the people on this planet to coordinate a resistance effort which has a chance of success, so I now step forward to speak the truth as it was told to me.

Though the specifics of this alliance are classified far above Top Secret, there are those who know of it through "unofficial" channels, and they're horrified by it. One of these people I spoke with personally, and he was well versed in the details of the understanding between the ruling class and this particular group of aliens. He was a being who claimed to come from a star system beyond our solar system, and judging from the type of technology they used, I believed him. He was saddened by the situation he saw on earth - where the leaders betray their own people in order to curry favor with an alien race.

This being seemed to be very familiar with the history and present status of these "local" aliens, and he told me that they had destroyed the environment on their own planet, forcing them underground. A hostile, radioactive environment caused each generation to be weaker, and genetic mutations became the norm until finally they were unable to reproduce at all. Even the healthier ones suffer from a severe debilitation of their immune systems, and are vulnerable to disease. For a time, this was counteracted by a process developed by their medical profession, but when all fertility among them was lost, the program came to a halt, and emergency action was taken. They sent scouts to their closest neighbor, earth, to determine if the life-giving materials they needed could be found here. After taking many different samples it was determined that though no perfect matches could be found, there was unlimited quantities of material available, and it could be adapted to fill their requirements. A large migration to Earth was planned and undertaken.

Our former neighbors knew that to conduct their operation covertly would not only be difficult for them, but also would place them in violation of the "watchdog" committee of which the being I spoke with seemed to be a member. These aliens had "crossed" the committee in the past, and wanted to avoid that complication at all costs - they couldn't afford committee interference in this operation, and the one way to assure non-interference was to make a legal treaty with the people of the region where they wished to conduct operations, thereby gaining official sanction for their activities. In the United States at least, this wasn't difficult, for the people had assigned the power to make such treaties in their behalf to a small group of elected officials. When the deal was struck, therefore, it was all quite legal, and the committee could not intervene.

The aliens would share technology with the Earthlings, and in exchange, all they requested was the right to collect biological "samples", conduct experiments, and live in peace. Our technocrats found this offer to be irresistible - a small price to pay for advanced technology - and they treasure each new revelation given them unaware that these alien technologies are some of the same practices which destroy their world environment, and forced them to seek survival on Earth. The being I spoke with didn't offer great details on this point, however. He was much more

concerned that I understand what the people were giving up in exchange for this technology, and so I also will place my focus on this subject.

As stated, the aliens require biological material in order to combat their physical deterioration, and here on Earth, the procedure adopted is as follows. Human, and in some cases other animal life, are abducted and medically examined by the aliens. They screen out those with genetic weaknesses, impaired immunity, and "incompatible tissue. Subjects found acceptable are indoctrinated into the alien mind set, which considers these humans to be special, and to have something very important to do. When the age of puberty is reached, the "chosen ones" discover what that important thing is. From female donors ovum is taken, from males, sperm. These "samples" are taken to a laboratory facility, where they are combined to form human embryo. Some of these embryos are then implanted into an acceptable, unsuspecting human female for a period of incubation. Within twelve weeks the aliens return to reap their "harvest" - rich in immunities, nutrients, viable cells, and surrounded by chemicals which inhibit rejection. After processing, this "material" is injected into these beings to nourish and strengthen their resistance to disease.

As indicated, not all embryos are submitted for human incubation - some remain in the lab. These are grown in culture for a short time, then are separated into individual cells. These cells are as yet undifferentiated, meaning they have not yet received the chemical signal which determines their specialized function. Such a cell, injected into a weak or diseased organ or blood stream, for example, will quickly become imprinted with the same code as the tissues which surround it, and will henceforth divide and multiply as heart tissue, lung tissue, white blood cell or whatever is desired. This is an effective alien method of combating degenerative disease, and the greater the degree of genetic compatibility between "donor" and recipient, the greater the effect. Their success rate using human "material" is therefore much lower than when they were able to gather material from among their own species, and recognizing this fact, they have embarked upon yet another area of "experimentation". This program is more limited in scope, but chilling in its implications, and concerns attempts to create a "hybrid". I was told few details on this process, and know only that they attempt this through gene "splicing", then the embryos undergo human incubation, and that thus far they've had limited success

I myself was selected early in life as an acceptable "donor", and have been forcibly abducted many times for this singular purpose. On one occasion which I clearly recall, a human being was present during the procedure, and I have many reasons for believing he was a member of the U.S. Navy. We spoke, and I expressed resentment at being used in this fashion, and at his obvious endorsement of the evil program just described. He was somewhat surprised at my knowledge of the project objectives but seemed gratified to have someone to talk freely with about it. He seemed proud to be involved in work with such great potential, and tried to convince me I was participating in something very important, for he indicated that this process had also been found to lengthen the life and improve the general health of humans who cooperated with the aliens. His attitude was relaxed - he had no fear of me - he was quite confident that the alien ability to "block" memory would protect his secret until I had become moot. Well, I did and DO remember, and though I fear these monsters, I must speak, and pray that I am heard by the victims of this evil coalition. This must cease, and earth leaders participating in this program must be identified and exposed. Those who have sworn to protect their trusting people from invasion and unlawful seizure must be tried for high treason according to the law of this land, for they have betrayed us. All other parasites feeding on we the People must be held accountable for their violation of our civil rights and trust, and be punished according to law. It has gone on far too long. It must stop. WE must stop it.

Cow Blood Promising as Stopgap in Humans

A realistic but potentially controversial supplement to human blood made of cow blood may be available within the next few years, pending government approval. The product is called Hemopure I solution and is scheduled to enter clinical trials this year after impressive

results in animal tests. Cow hemoglobin, which is similar in its amino acid and oxygen content to human hemoglobin, probably could be used best in the short term, such as in emergency blood-loss situations, scientists say. It can be stored indefinitely and contains 40 times more red blood cells than an equal amount of human blood.

Biopure Corp., which developed the product, says the cow blood is tested, purified, packaged and frozen for future use within two days of being collected. Initially, the company hopes to establish a veterinary blood bank to make Hemopure available for use in farm animals and pets and eventually to distribute it to major medical centers. But the developers expect controversy to arise over the use of animal blood in humans.



Abductee Training

Over the last ten years research into alien abductions of human beings has produced evidence that abductees are being trained on alien equipment. Types of training include: Flight Instruction, Weapons Training, Computers, and location of other abductees.

There are several scenarios or apparent purposes for this type of training (which is blocked from conscious memory). These scenarios hypothetically might be:

1. To operate alien equipment for the ruling forces of the planet in defense of the planet from other alien invaders.
2. To operate alien equipment for aliens in defense against ruling forces of the planet.

William Cooper, during 1990, has put out disturbing information that factions of the United States Government and the world power structure might decide to sequester any abductees that they can find. There are even marginally amusing stories of military bases that stock guillotines to behead abductees so that they can't be manipulated or their bodies used by alien forces. There is not sufficient hard evidence in the form of documents or other data to support these allegations.

There is also the idea that abductees would be stand-ins for the US Government (expendible) to enable domination of the planet after other events (alien invasion, planetary tilt, etc) occur.

Any scenario that seems to be out there seems to put the abductee at a disadvantage and under intense manipulation by one or more forces. These scenarios are not appropriate and must be changed as the power to do so arises. There are always more than two sides to any issue.

Post-Abduction Syndrome

Post-Abduction Syndrome is an expression that evolved several years ago to describe the process that can occur to an abductee after they are abducted. Very often, abductions can have such a negative effect on an individual that the effects can be very devastating and can last many years.

The effects of abduction can be generally classified into physical effects and psychic effects, all of which can have permanent effects on the individual. It is quite disconcerting that the "secret government" has knowledge that all this is happening, and even participates to a degree.

Physical problems from abductions can range from scarring (from having scoops of flesh removed) to intense organic problems. For human females, the problems often have a greater scope than with males or children. Since human females are used as part of the alien hybrid breeding process, reproductive problems from organic over-use of reproductive processes take their toll, often reflected by vaginal or navel (the navel is a favorite injection site) discharges. It is also common for female humans to acquire various infections. These infections are often based on plant-like (such as yeast) or staph type organisms.

Psychological problems can take their toll in the form of neurological disorders or disorders relating to the higher (bio-electrical) fields of the body, which have an effect on all fields (including the formative, repair-oriented field matrix of the human body). Use of implants often has an effect on pituitary or pineal gland function, which can also have marked psychological effects on the abductee.

Psychological symptoms can result from buried or blocked traumatic experience, producing anxiety that sometimes drastically interferes with the life of the individual.

Many victims of abduction (by aliens or components of the 'secret government' are only aware of inexplicable behavior on their part. This can lead to the desire to be regressed in order to unearth the source of the anxiety.

Many symptoms that result from abduction experiences can also occur in people that have apparently not had any abduction experiences. In any case, root causes must be dealt with. Treatment of symptoms alone is ineffective and will just postpone the resolution of the problem.

Sleep Disorders and Abduction

Since abductions, especially of human females and children, seem to occur mostly at night, sleep patterns are disturbed. The individual may have encounters during a specific time period of the night, which causes sleep anxieties and a generalized deterioration of health over a period of time.

Many people who read Streiber's "Communion" began to have or recall experiences with the Greys. They seemed to occur after these people went to bed. The book tends to raise vivid imagery, and it is thought by some that the effect on people is that it causes them to "resonate" on levels of fear that actually attract the Greys, especially if the individual knows what they look like.

Most people use light or sound (leaving it on) when sleeping to try to alleviate the problems that seem to arise when the person is sleeping in the dark. Leaving the light on does not reduce the feeling that many people have that "something is going to happen", which may be the result of the individuals experience over a long period of time. For example, it is known that human female implantations occur every four cycles (woman experience three light periods and one heavy one). Using this knowledge, it is possible to determine the most likely time period when abduction will take place.

There are also sexual components to abduction experiences. They can be the result of an actual sexual experience with an alien, the result of examination or probing of sexual organs, or the direct collection of sperm or eggs. Research on the production of hybrid alien children using human females seems to indicate that alien sperm are most often mated with human female eggs.

Since abduction experiences are very often blocked, the experiences can come out in the form of vivid dream states. The individual can then develop a fear of dreaming, which may lead to a fear of sleeping. Very often, abductees (short or long term) learn to get along with a lot less sleep than non-abductees.

Panic Type Disorders

Panic disorders, whether caused by abduction or not, are one of the most outstanding problems in society today. They can often manifest themselves in fears and phobias that seem to have little foundation in waking reality.

Since most abductions seem to take place when the individual is isolated from others, abductees often seek the company of others in an attempt to head off any further abduction attempt. Of course, efforts in this direction have no significant effect on alien plans.

Abductees very often develop fears of anything medically related, such as examinations or even being near a medical facility of any kind. The fear is based on alien exams, with the emotional experience leaking through psychological blocks that have been placed there either by the aliens or in a self-protective operation of the human mind that occurs as a result of the experience.

The abductee that fears medical exams could put off routine medical care, which contributes to a deteriorizing condition which weakens the individual and makes alien influence that much easier.

Most abductions take place when the abductee is alone or isolated, often in remote areas. From this arises fear of open spaces, long roads at night, or other outdoor related scenarios.

Children who are abducted may fear going back to a specific location. A significant degree of the trauma resulting from sexual abuse of children is due to that caused by their abduction by alien entities. Children are picked up and examined genitally as young as birth to four months old. It is a common occurrence and takes place every day. They may have strong fears of the bedroom, the basement, or other locations in the house.

At some point in the life of the abductee, panic reactions may become acute. They may then experience "racing" heartbeat, hyperventilation, and other reactions to their anxiety. These reactions may drastically interfere with daily routine and may cripple relationships with family and friends.

Another phenomenon that seems to occur is when an individual has a reaction to the complete lack of stimulus or to what would be considered "normal" activities for that individual. These reactions are emotional and transient in nature. On the positive side, some abductees will wake in an unexplainably euphoric state and remain that way for a significant period of time. On the negative side, they may experience rage at other individuals for seemingly innocuous behavior.

Abductees also may develop repulsion toward certain subjects or ideas for no apparent reason (from the abductees point of view).

It has been said that abductees may become "obsessed" with UFO research. I guess anyone who was being manipulated to that degree would want to find some answers - that's practical. It might seem like an "obsession" to the non-abductee, but so is stamp collecting an "obsession" to the person who doesn't care about stamps.

Many times, individuals may have reactions to events that seem inappropriate for the event that occurred. These reactions may be subtle or very significant. Reactions that have occurred as a direct result of people reading "Communion" or looking at the cover of the book have been documented. There are many people who cannot complete a reading of the book and will react very strongly to aliens or the contents of the book.

Some of these panic attacks are not the direct result of anxiety but are the result of memories that bleed through into conscious awareness. Individuals may experience terror and not know why. Dreams that have been vivid but confusing may take on increased importance.

Withdrawal of human consciousness from the body (see the section on the astral body elsewhere in the book) can occur naturally as in projection of consciousness or it can occur as a result of involuntary ejection of consciousness due to alien manipulation. Because of this, it may be hard for an individual to distinguish between the two processes if there is sufficient memory blockage.

Abductees often report floating sensations or that they were transported to another location during the night. They also may report missing time.

Part of the abduction of human females is the hybrid breeding that is occurring. Sometimes, women are shown the end product of the hybrid process - the actual child, and are asked to hold it or view it. When the abductee resumes waking consciousness in daily life, there may be an unexplained attitude toward children that has no apparent basis in experience.

Cynthia Crowell's reaction to the initial meeting with one of her hybrid children was that she expressed the desire to rip its arm off - a reaction which angered the aliens. Later, the reaction to the child had become less traumatic, and the aliens allowed her to view the child closely. The child had greenish yellow eyes with vertical slits instead of round pupils.

The avoidance posture toward children can develop in male or female humans as a result of this experience. It is more likely to take place with women because of their role in the alien agenda.

Because most of the memories are suppressed, women may often feel like they have a "missing baby" or that they were pregnant and didn't know it. There have been many cases where actual pregnancy was confirmed and the fetus mysteriously vanished after several months.

There are cases where women have been told by the abductors that they are going to have a baby (or feel like they are having a baby). They may experience vivid imagery or go through the motions of a "dummy birth".

There is concern that the effect of abduction on "psycho-sexual" development may be significant in children. When children reach four or five years old, examinations of the genital areas seems to increase. They, like adults, are poked, prodded and manipulated.

This process can cause some inherent embarrassment in children that are in puberty or approaching puberty. Many female humans have not yet been to a gynecological exam when they are first examined by the Greys or others who drop in with a similar interest.

Since there is no adult human input that would terminate the situation, there is a tendency for total dependency on the alien abductors. The abductors have been frequently know to cause/create feelings of pleasure in the abductee after exams, and this whole process could leave the abductee in the position of not wanting to leave. The whole situation ends up being a sexually oriented experience. Female aliens have been seen to induce ejaculation on young boys just prior to or during the extraction of sperm.

The result of this is that some adults are left with the "feeling that they were molested as a child" (they were, but not by humans).

Often, abductees are in direct sight of other abductees undergoing similar examinations. Depending on the individuals social programming and imposed limitations, this could produce the experiences "shame" and "guilt", which may have a significant impact on future social adjustment.

There is some evidence that abduction of human females has an impact on their preferences with human males. Some women have reported a new preference for short, dark haired men or powerful dominant men who "just make love and walk away".

If a female abductor is repeatedly dealing with a female human, then the human may develop a preference for females due to the sexual reinforcement gained through a string of abduction experiences.

Themes of sexuality may develop. Situations of "bondage" or masochism may evolve. Imagery and fantasies may assume themes seen in "science fiction".

There are a lot of other sexual problems that can arise from abduction. There are situations where humans can become "impotent" and obsesses with control of their bodies. Others can have unconscious experiences of "shame" or "guilt" arise during sexual experience.

With women, a common development is the loss of interest in sex. Sex could become the subject of unconscious fears and anxieties, destroying their sex life and their relationship. A sexual contact could be unconsciously viewed as another assault by abductors. Normal sexual relations become something to be avoided, tolerated, or endured. It's devastating.

Often, men and women develop an inability to be intimate. They might feel that they are "vulnerable" to their partner. They might feel an inability to trust the other partner. These problems can give men and women the feeling that they're "losing it". The problems can become so severe that suicide has been known to be a result.

The search for answers leads many to a lifelong search, and abductees will often become heavily involved in psychic studies and conferences. These areas do supply some answers to their questions.

Many abductees go to see psychiatric personnel in an effort to discover the reasons for their problems. The majority of professional therapists are not prepared or equipped to handle the idea of alien contact.

Many well meaning therapists try to convince the abductee that their problems stem from relationships in childhood, or that their vivid dreams result from suppressed sexuality or childhood sexual abuse.

The answer for some people is hypnotic regression and special counseling by an individual familiar with abduction and its special problems.

Most abductees initially have to deal with the problem of isolation. Many people understandably get the feeling that they are alone in their experience. Support groups can aid in dispelling this myth. There is very often no one that the abductee feels that they can confide in. Parents, when faced with abduction of their children, often think that it is a "phase" that the child will outgrow, and that it is a function of their imagination.

When the abductee is an adult and in a relationship, the partner may be mentally inflexible and unknowledgeable, and this may result in the end of the relationship. The partner may also believe the abductee, but fear that they themselves will become involved if they become involved with the abductee's problem.

Usually, most abductees locate someone that will believe what they are saying, but they still feel like they cannot freely discuss their experiences with just anyone. This is a problem, because the experiences are so unique that they often feel they must talk about them.

Very often, involvement with psychic organizations will fade when the individual discovers that the problems are caused by aliens. Knowledge of the abductions provides them with some answers that might have been vague before.

Responsibilities of the Abduction Researcher

Most abductees who undertake a process to understand what is happening to them eventually (with support) find themselves in a situation where they are gaining awareness and an opportunity to gain some control back in their lives. Since control is a vital concern to the abductee, the individual should not be forced into a recovery process.

Support and understanding of others who have been involved and have stabilized is vital to the reconciliation of some of the psychological problems that result from abduction.

Abductees are Divided into Categories

It has been observed that female humans that are being abducted and used as a hybrid breeding source generally seem to fall into two general breeding categories:

(1) Those females that are fairly young and can produce superior eggs. The aliens have recognized that eggs raised by human females that are "free" and unconfined are of better quality. These females are abducted and returned to their place of origin after each abduction.

(2a) Those females that are aging (either naturally or by virtue of the physical toll taken on the body by the alien agenda). It has been observed that human females in captivity produce a higher quantity of eggs but the quality is lower. These females are eventually retained in underground breeding facilities until their death. Many abductees have observed underground rooms with hundreds of human females all "wired for sound". The expressions on the faces of these females ranged from silent terror to a blank stare. *Some appeared to be pregnant beyond the normal three month in vitro breeding time.* An area such as this is known to exist in Nevada, and features security systems which can detect the presence of observers in the astral density by minute magnetic fluctuations.

(2b) It has also been discovered that abductees that are part of the hybrid breeding program that offer too much mental resistance are often abducted permanently to live out their lives in a "test tube" situation - held in stasis.

The two main aspects to the quality of genetic material the aliens are seeking appears to relate to both mental/psychic and physical predispositions present in the individual genetics. Both qualities are transferred to the fetus, so it is to the advantage of the aliens to have the human female in a non-captive situation that will produce better offspring.

Abduction experiences which appear to take place over several lifetimes have appeared in several cases investigated. According to what the Greys have told some abductees, individuals in this category are quite valuable to the Greys over those who have their participation restricted to the current lifetime. We know of at least two cases in which the abductee is aware of being abducted in their last existence as well as during the current one. In both cases, the last lifetime took place in Europe during the Nazi persecution of the Jews. That era and set of circumstances may have been where abduction of humans on a massive scale might have begun.

There is also evidence to suggest that psychic development in some individuals may be inversely proportional to their longterm tolerance of psychic abuse by the Greys.

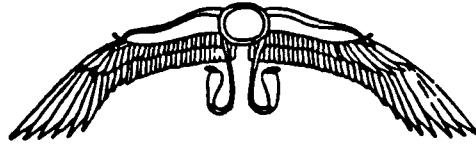

Exploring Memory Functions in the Abductee

Memory can be deleted and retrieved to varying degrees. During a hypnotic regression into an abduction experience, the abductee will often remember events even though conscious memory of them is absent or blocked.

Frequently, event scenarios will be present in smaller "chunks", seen as "sub-events", which can be retrieved and used to rebuild the entire experience.

There are different methods that can be used to retrieve memory; the specific ones used have varying degrees of success:

1. Hypnotic Regression
2. Dream work. Remembering, recording and discussing dreams.
3. Writing and clustering of ideas in an attempt to establish a flow of thoughts and associations. Diaries and notes.
4. Memory Drugs
5. Attempts at drawing and visual representations
6. Using functions of imagination to allow a way around different types of blocks.
7. Working on development of awareness and psychic functions

Research has brought forth the concept of the "double-block" that is placed on events that take place during abduction. Part of the block may be tied into the individual's survival functions, which insures that at least one of the blocks will always remain in place. It is also a common technique that the CIA and other agencies have used. It is termed "nested hypnosis", in which keys or elements to release information and memory may be nested within other hypnotic suggestions and programming.

Abductees who are prone to violent emotional reactions require more blocking than do those who passively deal with their abduction experience. It seems as though emotional displays cut down the overt usefulness of the abductee to the abductors.

When the abductee makes gains in awareness about specific aspects of the abduction scenario, the aliens often compensate by reinforcing previous blocks to memory, installing new blocks, or deleting memory traces of the events by electronic means.

Blocking memory is something that both the aliens and the abductee do. For the abductee, the block may be tied into a survival based response. For the aliens, the blockage is often to reduce emotional response from the abductee, which makes the individual easier to manipulate.

Research has indicated that individuals can usually regain partial memory of an abduction experience. Some elements, usually the undressing and direct examination of the individual, may be deeply blocked or removed all together.

When examination table experiences are recalled, they may be extremely vivid and often give rise to emotional responses on the part of the abductee. Over time, emotional responses can grow to be very highly charged and must continually be suppressed by the manipulating aliens. Suppressed emotion and hostilities can often contribute to the general physical decline of the individual and feelings of self-worth.

Collection of Subtle Energy from the Abductee

The aliens will test the abductee to see what kinds of emotional frequencies are produced when different kinds of stimuli are directed at the abductee. Stimuli can be physical (subsonics, light, or various forms of energy) or mental (inculcation of vivid images into the mind of the abductee). The aliens can examine what mental images are stored in the mind of the abductee and will select those images which are tied into emotions that they wish to evoke. The reason behind this is that the aliens involved can "collect" the energy that is radiated on certain frequencies and convert it to a transportable form that they can store for use later on.

Sometimes, the abductee will "learn" the kinds of emotional responses the aliens cannot tolerate and seek to reproduce these frequencies in an effort to irritate the aliens. This can cause the aliens to render the abductee unconscious in order to continue their work. Despite the unconsciousness, portions of the self seem to be able to remember the "learned" frequencies.

The Greys use technology that emits energy on frequencies that maintain a separation between the physical body of the abductee and its component field-bodies, including the emotional or astral body.

The presence of the emotional component seems to enhance the "quality" of the frequency spectrum that they wish to use.

The aspect of some species of Greys to collect energy has been also mentioned by Whitley Strieber. Some forms of energy need to be absorbed by entities in order to maintain their position adjacent to this physical density. Without this, they would be forced to drift back to their natural resonant frequency, which is more removed from human physicality. Density levels and different species are discussed elsewhere in this book.

Doorway Amnesia

Doorway amnesia is an effect that very often occurs upon entry or exit from a vehicle. The effect is produced because the energies involved in the vehicle affect the brain and consciousness on quantum levels.

It is experienced by the abductee as a lapse in memory covering the entry/exit time period. It may also be maintained while inside the craft. Each individual organic body is tied to a time track, and in an environment where time tracks are flexible the reference point for the physical body is absent. This can produce many kinds of effects on the consciousness of the abductee.

There have been cases where the abductee has come face to face with himself/herself in another body on another time track. They have been warned not to look the other body in the eye or there will be a "short circuit". What is thought to be the truth is that there would be a merging of consciousness on both time-tracks, which would "short circuit" some of the blocks that the aliens have installed in one or both of the bodies of the individual.

Effects inside of craft were reported by Air Force photographers taken to Twenty-Nine Palms base. These effects are described as the inside of the ship being many times the apparent outside size. For a complete description of this event, refer to the section on the Twenty-Nine Palms base elsewhere in the book.



The Abduction of Children

The abduction of children is different than adults. Much time appears to be spent in training. The training consists of conditioning for the adult abduction process to come. The conditioning process may include psychological programming (such as getting the child to fear medical authorities, who would examine the child and possibly discover alien interaction, or telling the child not to tell anyone).

The Greys are able to detect and perceive emotional responses from humans. Some of these responses (or the frequencies involved) the aliens find distasteful. In order to minimize their exposure to undesirable emotional wavelengths, the Greys will test humans and apply behavior modification techniques to block specific emotional states. Likewise, they will encourage emotional states in the child (and adult) that will result in emotional wavelengths that they can use. The Greys have the ability to "feed" on this energy. They have the ability to confine this emotional energy to containers that have internal fields that will "bottle" the energy, much like a magnetic bottle will hold a plasma. The effect of the use of this energy is like "vitamins" on the Greys. It gives them a boost in vitality.

The Greys also have the ability to pickup and gather the energy emitted through the eyes (sometimes called eloptic energy, or biological energy). The Grey uppermost in the group hierarchy always takes the position in front of the abductee in order to absorb this energy, which is upgraded in quantity and quality by induction of emotional processes in the human. This process is not done as often with children as with adults.

The Greys generally react differently to children. Research indicates that the Greys, because of their survival based status, hold children of all species in respect. The Reptilians, on the other hand, despise humans altogether. The Greys seem to spend more time being afraid of humans than disliking them. They prefer to subdue humans and take what they want from them in the form of biological products or energy frequencies.

Human children have been known to be abducted at birth along with the human mother. The earliest conscious memory of dealing with the Greys can occur as early as 16 months old. Usually, the child's memory of the event is erased by the Greys before returning the child to its point of origin.

The Greys apparently search for humans with favorable genetic matrix patterns and mental wavelengths. The importance of the emotional output varies with the age of the human; the older the human the more intense the emotional output can become.

Childhood symptoms of abductions that adults can recognize may include missing time, inexplicable wounds, unfounded fears, nightmares, physical scars with no known origin, and other symptoms similar to adults.

The Greys have the ability to extract knowledge and sensory information from the brain of the human and make use of that information when mentally controlling the consciousness of the human. This information may be woven into a scenario which is specifically geared toward modifying the behavior of the human.

With children, these scenarios can include anything from the last cartoon the child saw to impersonating another human that child knows. Considering that the Greys often medically examine the children, this could lead to another problem. If the Greys choose an image, perform their exam, and let the child go, the child may react in strange ways when it confronts the actual human the Greys may have impersonated. That human may get wrongly accused of sexual abuse of the child, especially if the child reacted negatively to a specific procedure. Budd Hopkins has also pointed this out.

Very often the child abductee may be visited at the same time as its mother or father. The whole family may be taken at once and dealt with. It is estimated that at least ten percent of the human population is regularly and systematically abducted by the Greys and other species. That number has been steadily rising as time goes on.

Psychosexual adjustment problems can occur with children and young adults because of their role in the alien abduction scenario. Many children are often abducted at the same time, and may view others being physically manipulated or become self-conscious of their own manipulation in the presence of others.

Children are sometimes abducted and never returned to their point of origin. The Greys may abduct a human child and raise them in their own environment to eventually become a manipulated human that they can use for their own purposes. Reptilian aliens are known to be carnivorous. It is also known that as far as humans are concerned, they prefer human children to adults. The bodies of human children are relatively uncontaminated with tobacco, alcohol, and other substances that are distasteful to that species. Research indicates that human children are being collected and stored by some species for that purpose.

Depending on the specific conscious memories the human child retains of the abduction experiences, the child may or may not be in a fear prone state. The problem for the human parent is how to help their children deal with whatever experience that they are having and minimize trauma connected with it.

First of all, if the child is involved with abductions there is nothing you can directly do to prevent it. The child, just as the adult, must be educated to expand its awareness and develop along constructive psychic paths in order to eventually deal with the Greys "on their own turf".

Children react differently to the experience than adults do; although the type of reaction depends on the character of interaction with the aliens, the aliens are generally more "considerate" when dealing with children. By "aliens" we are referring to the Greys and their cloned helpers. The probability of the children being returned in good condition by Reptilian based species is much less than with the Greys.

It is thought that the friendlier manner with which the Greys generally treat human children is because the Greys feel they have nothing to physically fear from a child. The Greys are generally paranoid of adult humans and will, in most cases, automatically seek to induce paralysis without consideration for the temperament of the individual human adult. Children are seen by the Greys as future targets of biophysical manipulation as far as their identity as humans is concerned.

Concepts of Consent, Overt and Covert

It is maintained by some that human beings actually consent to their interaction with the Greys. Sometimes the consent is overt. There are cases where it can be seen that the abductee adult will say something equivalent to "do anything you want to me but leave my child alone", or "do it and get it over with". There is also the aspect of covert or memory-blocked consent. It is possible that on "entity level", humans could agree to an interaction which would cause a learning experience for each of them - the human and the Grey. If this interaction is based on some "entity-level" karmic scenario, the memory of agreement to do something the entity might ordinarily find distasteful might have to be blocked in order for the scenario to occur as planned.

Displacement of Consciousness within Human Bodies

There are many cases where one consciousness has displaced another in a fetus or small child. That entity is only known by its exterior trappings (body or field matrix emanated), The case of Adrian (elsewhere in this book) illustrates one case where an entity who functioned in a Grey cultural format displaced the consciousness within a young body that was within a human cultural format.

The other cases where the entity housed in a human body is displaced involve several different operations:

1. Operations where the entity housed in a human body is removed and stored and another entity is placed (or voluntarily comes into) into the body for an indeterminate period.
2. Operations which displace an entity only during a period of manipulation. Generally, this function makes use of electrostatics and theta wave entrainment to exteriorize the resident entity within the body and reintegrate the fields after the transfer is complete. The same technical process is used to modify the bodies field matrices to implant programming or modify biophysical parameters.

Integration of Consciousness into Synthetic Bodies and Injection of Human Memory Patterns

There are cases where the memory of a human abductee is holographically reproduced within the marginally sentient consciousness of a synthetically constructed body. The transfer of memory only allows access to memory and experience.

Behavioral reactions after integration are often very different from those of the original sentient being. See the case elsewhere in the book where an abductee encounters his own clone.

Multi-level Involvement Scenarios

It could well be that the human being, as an entity, has ongoing interactions with the Greys that occur in many bodies "over several lifetimes". Grey interaction is known to extend over as many as four generations in a single family line, with each of those individuals realizing involvement with the Greys in additional or parallel life streams.

Human Actions That Have Halted Activities of the Greys

The Greys have been known to halt the process of abduction based on the actions of the abductee or other individual. A number of interesting situations illustrate this point:

1. Researcher Clifford Stone on one occasion received word of an impending abduction and rushed out to the site in his car in an attempt to interfere. As he reached the site, he saw the Greys dragging a little boy away from a station wagon into a waiting disk. Stone, with incredible presence of mind, rushed into the disk with a can of hairspray and a lighter and burned the Grey that was holding the child, grabbed the child and ran out. The disk took off immediately and all was well.
2. Since the basic awareness of a human being is within the awareness of the Greys, they are able to perceive the human mind, belief structures, and other attributes. There are two interesting cases that illustrate this point:
 - a. On one occasion, an abductee who was advanced psychically tried to perform the function of looking through the eyes of the Grey who was looking at her. A shift in focus took place due to the effort of will of the abductee, and she was then looking at her body sitting on the bed through the eyes of the Grey. Within seconds,

the Grey realized what had happened and forced her focus back into her body.

b. On one occasion, an abduction occurred on a farm in the southern United States. The farmer, who had a rigid and strong belief structure, perceived several Greys hauling off his young son. He yelled at the Greys, "Stop! If you don't stop my God will crush your ship!". The Greys halted, glared at him, let the boy go, climbed into the ship and took off. The point is that the human could believe *anything* strongly enough and as far as the Greys were concerned, it would be fact. The Greys, having a group oriented mental structure, cannot process policy decisions without consultation with Greys higher in their social hierarchy. The result can be confusion when they are faced with events that they don't expect. They will often cease operations until a decision is made. It seems to be an inherent operational "weakness".

Individuals Immune to Grey Manipulation

There are *some* individuals that Grey technology has no effect on. This may occur for two reasons: the individuals natural biophysical or psychic development may allow the individual to exercise their will over that of the Greys, or the individual has been implanted by another race (such as the Orange) to either magnify natural abilities or block manipulative wavelengths the Greys would use. The reason for "constructive" implantation in these cases usually involve:

1. A situation where the second species desires to covertly observe Grey or human activities.
2. A situation where elements of the Government wish to observe Grey or human activities.
3. To support the cultural activities of the human that are essentially anti-Grey in nature. These could include predispositions for the individual to educate others with information about the Greys that the Greys wish to hide.

As you can see below, some people just can't seem to make the connection. Another valient effort on the edge, meanwhile baffling people with bull....

COLLEGE OF ENGINEERING



VIRGINIA POLYTECHNIC INSTITUTE AND STATE UNIVERSITY

Blacksburg, Virginia 24061-0219

DEPARTMENT OF ENGINEERING SCIENCE AND MECHANICS

FACSIMILE: (703) 251-4574

TREAT 11

Second Conference on **Treatment and Research on Experienced Anomalous Trauma**
Virginia Polytechnic Institute and State University Blacksburg,
VA
February 1-4, 1990

Rima E. Lalow, MD
13 Summit Terrace
Dobbs Ferry, NY 10522
(914) 693-8827

Experienced Anomalous Trauma (EAT)

Is seen when a variety of physical and psychological trauma sequelae are present despite the absence of identifiable traumatic insult. The patient experiences these sequelae even though the nature (and perhaps event-level reality) of the trauma is thus unexplained. Findings consistent with Post Traumatic Stress Disorder (PTSD) are often present. A wide variety of atypical physical findings inconsistent with known psychosomatic mechanisms may also be present. Surprisingly, psychosis and other major distortions of reality testing and functioning are generally absent; psychometric abnormalities are usually not present. The presence of traumatic sequelae in the absence of discernable trauma raises questions about the relationship of PTSD and other concomitants of traumatic insult to event-level trauma, the possibility of psychosomatic disturbances at an even more profound level than that currently understood, and the surprisingly consistent content of EAT. Preliminary information indicates that EAT presents in a highly consistent manner across demographic, age and cultural lines world-wide. This presentation is highly congruent between patients and across cultures. While almost no professional literature yet exists on this phenomenon, clinicians in a wide variety of specialties and settings have reported patients demonstrating EAT.

Physical Analysis of an Alleged Alien Implant David Pritchard, PhD: Careful analysis (including SEM, ion ratio analysis and other advanced techniques) has been applied to an alleged alien implant. The results of this extensive analysis will be presented.

Hypnosis and UFO Abductions T. Edward Bullard, PhD: Hypnosis and EAT as embodied in UFO abductions scenarios have been the subjects of much speculation. The speaker will consider the relationship between the process of hypnosis and scenarios of UFO abductions. Concordance of reports with and without hypnosis, independence of reports from investigator bias and folkloric aspects of story elements will be considered.

Correlations between UFO and EAT Reports Stanton T. Friedman: Considerable evidence has been amassed which documents the existence of anomalous craft. The relationship between the UFO encounter and the paradigmatic EAT experience, UFO abduction, remains problematic. This relationship will be discussed.

The Neurological and Cultural Nature of Evidence Charles Laughlin, PhD: The evaluation of evidence is both a neurological and a cultural process. The speaker will define the neurophysiological processing systems through which reality is assessed and the cultural assumptions which define our belief system about reality and evidence.

Human Multidimensional Anatomy

There is considerable evidence to suggest that there exists a holographic energy template associated with a physical body. This etheric body is a body which looks quite similar to the physical body over which it is superimposed.

The etheric body also carries spatial information on how the developing fetus is to unfold in utero, and also the structural data for growth and repair of the adult organism. This energetic structure works together with cellular genetic mechanisms. The physical body is connected to and dependent upon the etheric body for cellular guidance - the physical body cannot be maintained without it. If the etheric field becomes distorted, physical disease soon follows. Many illnesses have their origin in distortions of the supportive etheric field.

The etheric body is composed of matter, but it is of a different density and frequency than the matter composing the physical body. It is not completely separated from the physical system with which it interacts. There are specific channels of energy exchange which allow the flow of information to move from one system to another. These channels have been discussed in Eastern literature.

The Acupuncture Meridian System

Ancient Chinese theory has it that the acupuncture points on the human body are points along an unseen meridian system that runs deeply through the tissues of the body. Through these meridians passes nutritive energy bearing coded information.

There were a series of studies on the anatomic nature of the meridian system in animals which were carried out in Korea during the 1960's by a team of researchers headed by Professor Kim B.Han.

Kim's histologic studies of the tubular meridian system showed that it appeared to be divided into a superficial system and a deep system. The deep system was further subdivided into various sub-systems. The first of these deep meridian systems was called the Internal Duct System. These tubules were found free-floating within the vascular and lymphatic vessels, penetrating the vessel walls at entry and exit points. Fluids within these internal ducts were usually found to travel in the same direction as the flow in the vessel they were discovered in. In certain circumstances ductal fluids were noted to flow in the opposite direction.

The fact that these ducts penetrate and leave the vessel walls indicates that the formation of these ducts is different (and perhaps earlier in time) than the origin of the vascular and lymph systems. The meridians may act as spatial guides for the growth and development of the vascular and lymphatic systems. As vessels developed they would grow around the meridians.

A second series of tubules was characterized and called the Intra-External Duct System. These ducts are found along the surface of internal organs and appear to form a network which is entirely independent of the vascular, lymphatic and nervous systems. A third series, known as the External Duct System, was found to run alongside the outer surface of the walls of blood and lymphatic vessels. These ducts are also found in layers of the skin and are known there as the Superficial Duct System. It is this latter superficial system which is most familiar to classical acupuncturists. The fourth series of tubules, known as the Neural Duct System, are distributed in the central and peripheral nervous systems.

All the ductules were eventually found to be interconnected (from superficial to deep systems) so that the continuity of the whole system was maintained. The various duct systems are linked together via the connection of the terminal ductules of the different systems.

Kim found that the terminal ductules reach the tissue cell nuclei. Also, spaced at intervals along these meridians, Kim found special small corpuscles. Those corpuscles in the Superficial Duct System seem to lie beneath, and correspond with, the classical acupuncture points and meridians of the body.

Fluid extracted from these tubules revealed high concentrations of DNA, RNA, amino acids, hyaluronic acid, sixteen types of free nucleotides, adrenaline, corticosteroids, estrogen, and other hormonal substances in levels far different from those ordinarily found in the blood stream. It is apparent that there is an important relationship between the acupuncture meridian system and the endocrine regulation of the physical body. It was apparent during experiments that when meridians get severed, serious vascular degeneration takes place. There was also a change in reflex time, which was prolonged more than 500 percent. Meridians provide a specialized nutritive flow to the organs of the body.

Kim found that meridian ducts, in some species, form within 15 hours of conception. This would suggest that the functioning of the meridian systems exert an influence on the migration and spatial orientation of the internal organs. Because the meridians connect to each cell's genetic control center, the meridians also play an important role in both replication and differentiation of all the cells in the body.

Dr Harold Burr carried out experiments mapping electrical fields around developing embryos. Through his research, he discovered that an electrical axis developed in the unfertilized egg which corresponded with the future orientation of the brain and central nervous system in the adult. The creation of such an electrical axis forms a waveguide for a directional energy field that provides spatial orientation to the cells in the developing embryo. It was also discovered that the contour of the electrical field of embryos followed the shape of the adult.

It would appear from the research of these and other scientists that the meridian system forms an interface between the etheric and the physical body. It is the first physical link between the two.

Electrographic researchers have found that changes in the acupuncture points may precede the changes of physical illness in the body by hours, days, and even weeks.

The Chakras and the Nadis

The Chakras are now finding their eventual validation with the evolution of subtle-energy technologies. From a physiological standpoint, the Chakras appear to be involved with the flow of higher energies via specific subtle energetic channels into the cellular structure of the body. At one level, they seem to function as energy transformers, stepping down energy of one form and frequency to a lower level. This energy, in turn, is translated into hormonal, physiological, and ultimately cellular changes within the body. There appear to be at least seven (7) major chakras associated with the physical body.

Anatomically, each major chakra is associated with a major nerve plexus and a major endocrine gland. See the diagram. There are also minor chakras involved. There are two on the palms of the hands, two on the soles of the feet, and one other one associated with parts of the medulla in the brain. Each of the seven major chakras is also associated with a particular type of psychic functioning. The ajna or brow chakra is associated with clear seeing, or clairvoyance. Subjectively, it is like a window opens up in the darkness ahead of you with your eyes closed. Inside the window it is bright and you can see things.

The primary chakras originate at the level of the etheric body. The chakras are, in turn, connected to each other and to portions of the physical-cellular structure via fine subtle channels known as Nadis.

The Nadis are different from the meridians, which actually have a physical counterpart in the meridian duct systems. The Nadis represent an extensive network of fluid-like energies which parallel the bodily nerves in their abundance. Various sources have described up to 72,000 nadis or etheric channels of energy in the subtle anatomy of the body. These channels are interwoven with the physical nervous system.

Dysfunction at the level of the Chakras and Nadis can be associated with pathological changes in the nervous system.

Research by Dr. Hiroshi Motoyama in Japan has presented findings that confirm the presence of the chakra system in human beings. His work is covered in "Science and the Evolution of Consciousness: Chakras, Ki, and Psi" (Brookline, MA: Autumn Press, Inc, 1978).

Motoyama found that certain individuals could consciously project energy through their chakras. When they did so, significant electrical field disturbances emanated from their activated chakras. Itzhak Bentov, a researcher of physiological changes associated with meditation, has duplicated Motoyama's findings regarding electrostatic energy emission from the chakras.

Another interesting study by Dr. Valerie Hunt at UCLA used more conventional measuring equipment in a study of the chakras and the human energy field. Hunt found regular, high frequency, sinewave oscillations coming from these points that had never previously been recorded (1978). The normal frequency of brain waves is between 0 and 100 cps, with most information occurring between 0 and 30 cps.

In comparison, muscle frequency goes up to about 225 cps and the heart goes up to about 250 cps. The readings from the chakras was in a band between 100 and 1600 cps - far higher than what has been traditionally found radiating from the human body. Each color of the human aura is associated with a different wave pattern, and these wave patterns were recorded by Dr. Hunt at the chakra points. When colors such as "white light" were seen in the auric field, the frequency signal measured was over 1000 cps. Huny has hypothesized that this high frequency level is actually a subharmonic of an original frequency signal which is in the range of many thousands of cycles per second: a subharmonic of the original subtle energy of the chakra.

The Human Frequency Spectrum

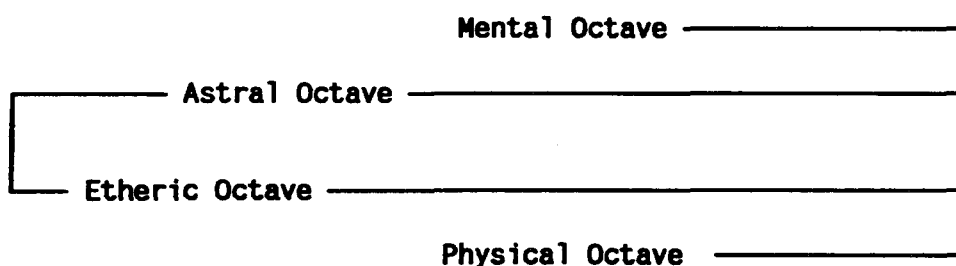

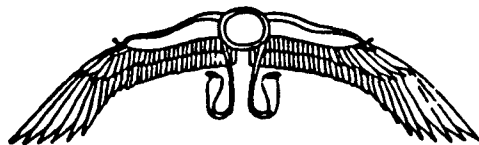

The Astral Body

The astral body is composed of astral matter, which is a subtle substance of even higher frequencies than etheric matter. Knowledge about this part of subtle human anatomy has been taught since the earliest Egyptian dynasties. The astral body is another component of the total multidimensional body that is superimposed over the physical body. Because astral matter exists in a frequency band that is well above etheric and physical matter, it coexists with and occupies the same space as the other two.

According to esoteric sources, the astral body, like the etheric body, also has seven major chakras. Like the etheric chakras, they are transformers of energy. Since the astral body is involved with emotional expression, the astral chakras provide a subtle energy connection whereby a person's emotional state can disturb or enhance physical health.

Another name for the astral body has been the desire body or emotional body. Fear is one of the dominant astral energies. The degree to which people are affected by these desires and fears governs the extent and nature of one's personality expression upon this frequency. Most physicians consider human emotional expression to be a characteristic of neural activity of the limbic system within the brain. The limbic system is only a subsidiary system to higher energy systems which also have input into the system.

Unlike the etheric body, which supports and energizes the physical body, the astral body also functions as a vehicle of consciousness which can exist separately from, yet connected to, the physical body.

The mobile consciousness of the individual can interact with the environment via the astral body while the physical body is inactive.

Research efforts have established the presence of the astral projection of consciousness, as well as the ability of entities to detect a projected consciousness. In fact, many of the underground installations have security systems which range into the astral in order to detect intrusion. Some of the security systems on the Nevada Test Site and Dulce have this feature.

Experiments carried out at Stanford Research Institute by physicists Targ and Puthoff in 1974 indicate a doubling of sine wave frequency of a magnetometer during a projection of consciousness. The evidence from these and other experiments implies that the astral body can create electromagnetic disturbances of lower octave harmonic energies which can be measured by sensitive electronic equipment.

The astral domain has certain unique properties, one of which is the principle that astrally or emotionally charged thoughts have a life of their own. They exist as distinct energy fields, or thought-forms with unique shapes, colors and characteristics.

Higher Bodies

The first of the subtle bodies which extend into the frequency range beyond that of the astral body is known as the mental body.

The mental body is the vehicle through which the self manifests and expresses the concrete intellect. The mental body also has its corresponding chakras which are ultimately linked to the physical form. On the mental level, thoughtforms may represent purely mental ideas that an individual is (or will be) working on. If the mental body is functioning properly, it allows the individual to think clearly and to focus mental energies in appropriate directions with force and clarity. Healing a person at the mental level is stronger and produces long lasting results than healing from either the astral or etheric levels.

Beyond the mental fields, there are what are known as the casual fields, or casual body. It is the casual body which is the closest thing to the individual Self. The casual body is involved with the area of abstract ideas and concepts. Casual consciousness deals with the essence of a subject while the mental level studies the subject's details. The lower mental body dwells upon mental images obtained from sensations, and analytically reasons about purely concrete objects. The casual body deals with the essence of substance and true causes behind the illusion of appearance. The casual density is a world of realities. On this level, we no longer deal with emotions, ideas, or conceptions, but with the essence and underlying nature of the thing in question.

Frequency Models

Due to the perceptual limiting factors of the physical brain, the conscious mind is ordinarily locked into a fixed space/time reference, or time-track. This refers to the Earth time-frame of reference, and the locked vantage point.

Astral projection may be viewed as the transfer of consciousness from the neuronal connections and fixed time-frame of the physical brain into the astral vehicle of consciousness. The autonomic nervous system allows the body to function normally while the individual entity is outside it.

Manipulations Involving Discrete Energies

A full understanding of the many parameters involved in abduction cannot be attained unless one has an understanding that encompasses the human being in a multi-dimensional sense. The concept of astral matter and the various energy field bodies of the human being has to be understood- this is one of the interface areas where alien technology can influence the human entity.

Astral matter is matter of a density finer than what is culturally viewed as being "matter". The subatomic particles have different characteristics that cause them to be attracted to each other in the presence of a gravitational field rather than to physical matter. Both kinds of matter are mostly empty space. The components of each type of matter simply slip by each other.

Condensed Knowledge

* Photons that make up the two types of matter also have different characteristics.

* Astral matter is affected by psychic energy or energies that occur in the astral frequency band.

* The difference between living and non-living matter is that living matter is linked to astral matter but non-living matter is not.

* Complex organic molecules of physical matter can form a chemical bond with similarly constructed molecules of astral matter, and the resulting structure shows the characteristics of life.

* The interaction between astral matter and the chemical reaction with physical matter takes place only within living molecules and not within simpler molecules. The vibrational frequencies of photons produced when electrons of both physical and astral matter change energy levels are the same, allowing physical photons to convert to astral and vice versa. This interaction occurs only in certain kinds of molecules, specifically DNA related ones. These energy conversions allow a chemical bonding to take place of the two molecules are similar enough. Astral matter plays a part in cell division and the whole genetic process - it affects the reduplication of DNA, one of the basic building blocks of life. The dissolution referred to as "death" by humans is caused by the breaking of the bonds between physical and astral matter.

* Some of the electromagnetic energy generated chemically by the cells metabolic process is converted into astral energy by links between the physical and astral molecules. This energy flows into the astral matter that composes the somatic soul (primitive soul linked cell by cell to the body), powering various functions and providing the raw materials for regeneration of astral matter. Some electromagnetic energy is converted into energies on the astral level, passing into the somatic soul. and converted there to astral matter to perform cellular growth and repair.

* Human entities have two "souls". The somatic soul we have been talking about is a primitive structure - an astral body that is only a reflection of the physical structure of the body hosting the entity.

* The body-soul is alive in the sense that it is made up of living astral matter, but it is not sentient. It has a separate nervous system that is linked to the third density nervous system but it has no mind.

* The structure humans refer to as the soul is an entirely separate astral composite which could be designated the astral soul.

* The astral soul is connected to the body-souls nervous system by a chord-like structure. Energy flows into the astral soul from the body soul, as well as from the physical body. This energy is the astral souls only efficient source of energy - an energy that is lost when the body loses the eventual capacity to maintain the astral connection. The chemical connection is regulated by processes within the physical body.

* A cell of living physical matter cannot divide unless the astral cell linked to it also divides. Living cells and molecules only exist as astral-physical pairs. This is why many complex organic reactions can only occur within living matter, and why alien entities visiting the Earth can only derive their bio-genetic needs from humans and other earthbound biological entities. They do not have the physical processes to synthesize what they require.

* A new body-soul is created during the embryonic development of the physical body.

* Human entities have one mind in the physical brain and one in the astral soul. Both have separate consciousness. Normally each is conscious when the other isn't. They are conscious simultaneously during certain states of altered consciousness.

* The astral "plane" is a condition and not a place. Entities can occupy the same space but not both the same space and same frequency without displacement.

* There are "transmission lines" of astral matter that connect one soul to another. They allow telepathic communication with greater power and range than "broadcast" telepathy.

* These astral threads are created spontaneously when astral souls come into contact with one another while generating large amounts of psychic energy.

NOTES

March 10, 1989

Received NAR and I suppose it was a little overwhelming to me. It was the first time I had actually sat down and read about "me". I appreciate you giving me so much space to present my story and I hope to be able to contribute in future issues. All of the material I send to you has been verified as far as it can be and I will send only material which will help establish and corroborate other peoples' experiences.

First I would like to comment on your article DATELINE NEVADA-DREAM-LAND EXPLORATIONS. Maybe we should do most of our investigations from the astral realm! Not only do I believe the material is correct, but I have a fellow whom I have been in touch with since 1987 and he has given me confidential information about the underground facility in which he had the pleasure of visiting. His name is Donavon Masters, and is a resident of Liberty, South Carolina. He in fact has stated on many occasions that he feels we were abducted or saw one another on board a craft of some kind or in an underground facility. We had never met or exchanged pictures until one day we decided to send a picture along. When we both saw the other, we were so shocked that we didn't even call or write for some time. The shock was just too much. You see, I remember seeing him standing in a hallway by a door looking in watching me being examined on a metal table. The alien who was in charge turned to him and telepathically asked him to leave the room immediately! He claims I am that woman he saw! He described a blue color to the underground facility and he saw men and women there also. He has seen the conveyor systems I have witnessed and describes them exactly as I would. He agrees the facility has to be in sections because we both were taken to different areas and saw different things. He also says he saw what appeared to be military soldiers with weapons of some kind on their heavy black belt. He also describes tones that we can't hear, but feel on our skin. He as well as myself have seen electronic equipment and huge freight elevators for transporting heavy equipment. Neither of us has exchanged this information until a couple of weeks ago when he called me out of the blue and said he had something he needed to talk with me about and it was of a personal nature. He also said it made him cry every time he pictured me laying on that table being examined. Also I have seen the little fetuses and they are hooked up to some kind of equipment. So the information you are receiving is correct by what Donavon and I have seen.

I would also like to comment on Mr. Taff's letter to NAR. I always like to state for the record that the real experts in UFOLOGY are the participants or abductees, so I feel somewhat qualified in commenting on his belief that no underground facility exists beneath the Groom Lake Area. I just spoke to another one of my contacts that have worked at Nellis Air Force Base as an air traffic controller and also another person in their family who used to work at the underground facility at Groom Lake. He told of having to use a covering over his head when going from one area to another and also if a certain siren or warning alarm went off he knew to drop to the ground immediately or drastic measures would be taken. Since his retirement from the sensitive area, he and his wife have been constantly harrassed by government officials and obviously do not want him speaking to anyone having to do with UFOLOGY. He

personally refused to answer any more of my questions and stated that he had to take an oath of silence and could never speak of what he did or saw at this underground facility. He did acknowledge that they are experimenting with alien-government craft and he knew they kept these craft in a high security area. Other than that he couldn't give me more details. His whole family have had UFO abduction experiences when living in and around Delta, Colorado. There are four of them that claim they have been taken to an underground facility before. They do not know whether it was in Nevada or Colorado or New Mexico, but the details I have been able to retrieve all corroborate my abduction and experience underground and coincides with Mr. Masters memories. Since none of us have had any close ties to the other, I find it hard to believe that anyone could categorically deny the possible existence of such underground bases.

As for the underground facility at Dulce, New Mexico...I wish it were only a movie, but it happens to be true. It exists and is still functional today. One UFOLOGIST I spoke to recently stated he spoke with a man who helped dig those tunnels at Dulce many years ago when he was working for a Page Construction Company. He has asked that his real identity not be revealed because of the government connections with this facility. He has no reason to lie or make up such a tall tale. The facts are these, Mr. Taff, not only have I been abducted and taken to the underground base at Dulce, but I have several other sane individuals that all give the same details time and time again. These people do not know one another and most have never heard of The Dulce Papers. Of course, I cannot confirm some of what was in those particular papers, but I know what " I " saw and experienced when I recently visited there. Believe me, I knew I had been taken there. I saw the tanks with fluid in them being stirred by something and I saw the guards and their elaborate electronic security system. I also saw ~~clear~~ containers with people in them! Believe me, I wish this were only a dream, but more and more people are confirming the same visions and areas and this area cannot be taken so lightly! I have to ask Mr. Taff if he has ever had any UFO abductions and if so, how can he be so critical of others experiences? Let me put it this way, when you get into an elevator and push the "down" button and actually feel the descent, you know you are going down. This is a reality for so many of us that have been taken to this underground facility in the Dulce area. It is a knowing experience, not a fabrication. If I wanted to tell a tall tale, it wouldn't have large tanks, guards, horrid smells and dark areas with conveyor systems in them! The fact is let someone prove to us, the abductees, that Dulce doesn't exist. Then and only then will we believe in fabrications. Yes, it may be a case of the blind leading the blind, but atleast when we put our pieces of the puzzle together, we can finally see!

Do us all a favor and don't try to investigate such sensitive areas. Remember they only exist in the minds of the abductees!

I am enclosing more material from " The Triad Experiment ". I only hope it can help you to correlate all this data and give us a stonger base(excuse the pun) in which to stand upon.

Respectfully,
Christa Tilton
Christa Tilton

UNDERGROUND UFO BASE Suspected BY OFFICIALS IN WASHINGTON STATE



Southeast of Tacoma, Wash. is the Yakima Indian Reservation. Of special interest is one particular section 40 miles wide and 70 miles long, bordered on the west by the Cascade Mountain Range. It is an area of canyons and heavily forested regions. Thought to have been at one time a giant lake or inland sea, the valley is essentially closed to the public and special permits are required to enter.

By 1971, UFO-Sasquatch related incidents had increased to such alarming proportions that Willard J. Vogel, Staff Fire Control Officer, stationed on the Reservation for 21 years, knew he needed a scientific opinion.

In August 1972, engineer David Akers was dispatched for concentrated observation of the

UFO activity. He was equipped with cameras and special electronic gear for detecting nuclear and infrared radiation. On his very first night after arriving at an area of intense activity known as Toppenish Ridge, the scientist saw two round, with a reddish-orange glow, UFOs.

Forestry personnel, like Dorthea Sturm, have heard unusual sounds for years now, coming from underground. Occasionally accompanied by a high-frequency noise which hurts the ears.

From deep within the dark, restricted canyons, "glows" have been observed. Yet this area is not accessible by foot or vehicle!

Low-flying silver cigar-shaped craft have been seen to disappear into the deep canyon known as the Middle Fork of Toppenish Creek.

Dry Creek disappears into the ground as it flows eastward. "Trout marked and placed in the upper portion of the Creek have been caught in the two lakes at the bottom of the north slope of the Toppenish Ridge.

Subterranean Caves in the area are being secretly used by UFOs.

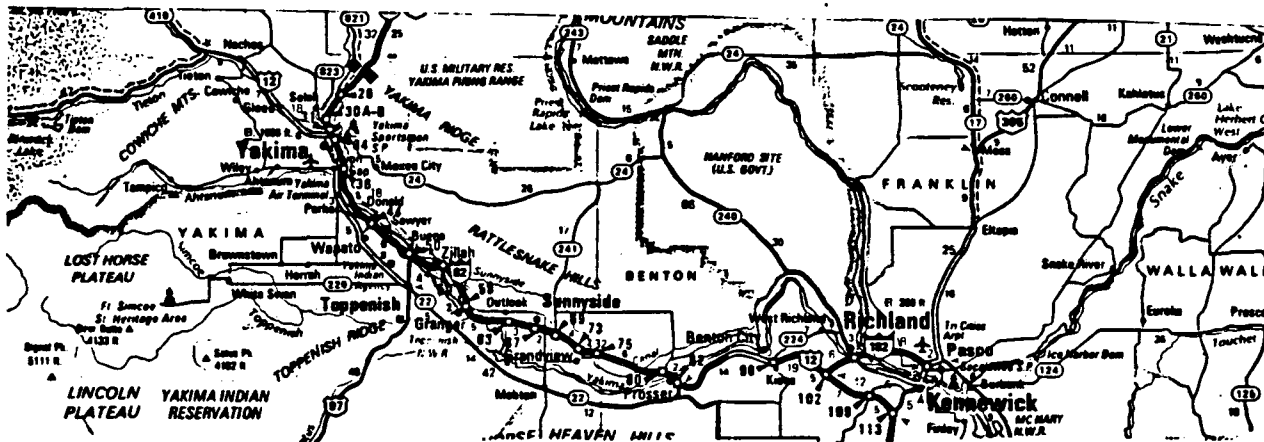

Underground UFO Bases and Way Stations

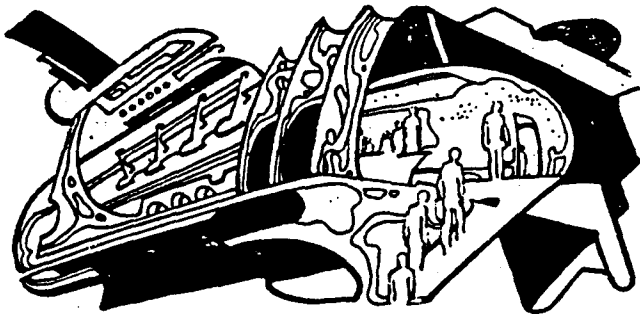

Alien beings have established bases in selective areas around the globe.

In central Texas's Robertson County - UFOs have virtually become nightly callers. Along with related ground level phenomena, including : Unexplained tracks on the ground ; Mysterious deaths and disappearances of livestock ; the interference of normal radio reception ; strange code being received on citizens band radio ; power black outs ; etc.

UFO's are using the area near Calvert, Texas as a base or way station - Caverns exist beneath farmland on the outskirts of town. "There is a complex network of Caves and Tunnels which connect somewhere underground. A check of geographical survey maps will show that Calvert is built directly on top of a fault line which zigzags for miles in all directions." The ranchers and farmers in this area have reported hearing peculiar noises coming from deep beneath their feet. "Individuals living five or six miles outside Calvert have repeatedly been driven out of their homes into the cool evening air by the sound of generators. It appears to them as if a steady droning noise is originating from all directions but is loudest when ears are placed to the ground." This bit of information has led me to conclude that UFOs operating around here have established bases for themselves far beneath the Earth's crust.

Going a step further, UFO-nauts are probably obtaining the necessary energy to power their ships and bases by making use of existing underground bodies of water. "This portion of the state is crisscrossed with hot mineral streams that flow silently deep inside the Earth. Placed under extreme pressure, these streams could make one hell of a hydrodynamic generator, supplying any space visitors with all the energy they need and without having to construct anything at all above ground which would give their presence away."

Southern California, as well, has UFO , Sasquatch incidents and strange underground occurrences. One of the most significant took place in April 1973, when three students camped in the San Gabriel Mountains on the western edge of the great Mojave Desert, "felt uneasy" and suddenly saw a gigantic man-like figure that frightened the campers. The next day , three-toed footprints measuring 18 inches long were found in the hard-packed soil of the area. The UFO Research Institute (UFORI) in Redondo Beach, Calif. was called in for scientific evaluation. After extensive field work in the campground area, UFORI discovered the sound of geared machinery and what might be compared to hydroelectric plant noise coming from 'beneath the forest floor'. While beyond normal hearing range, the subterranean sounds were picked up by special microphones placed directly on the ground. Nearby the remote campground is an abandoned silver mine which cuts through the mountain. One end has been closed by landslides and the other end sealed off by forestry personnel to protect explorers from the dangers of cave-ins. Sounds of operating machinery have been recorded coming from within the mine AFTER MIDNIGHT. Sightings of UFOs in this area are common place.

We are dealing with a superior technology with all the hallmarks of a military operation on a very large scale. Though most of the UFOs sighted are from the Inner Earth, for the simple reason that this is their home base, there are other ufo-nauts keeping a watchful eye on us.



The 'Hefferlin Manuscript' of the late 1940's informs us of the existence of a world wide Ancient tunnel system. One entrance into this system being in the Superstition Mountains of Arizona. "Another TUNNEL ends in a now-closed Cave in the Southwestern part of the United States in an Indian Reservation. Another Branch Line ends in Northwestern Wyoming, due west of Sheridan and some two hundred feet or more up the side of a mountain, this Tunnel seems to have been twisted and sheared off, leaving a distorted and pinched outlet. When we consider the great density and toughness of the metal lining the Tunnels, a metal that even earthquakes and great land mass movements cannot break, we wonder what titanic force sheared and twisted the Sheridan Tunnel end."

"At Tunnel ends and all Terminals there are great doors that seal each Tunnel, section by section, and all tunnels are empty. Only the Terminal Depots have any Machinery in them, and these are for Handling Freight and Fighting Equipment."

"Each Terminal Depot is a great storehouse of numerous levels deep for medical supplies, concentrated foods and food essences. Here too are stored many fighting machines and quantities of small arms (personal equipment) for army uses. These are mostly atomic blaster types." All Tunnels are lighted by a Cold Light System.

It is interesting to note that between Sheridan and "The Medicine Wheel" is Tongue River Cave. Spiraling down into the depths of the earth from an entrance 400 feet above the cascading river is an enormous limestone Cavern extending more than 6,700 feet into the Subterranean World. Here lies an extensive, far from fully explored, network of tunnels, and rooms of varying sizes. Far inside we find waterfalls and an Underground River.

THE LARAMIE REPUBLICAN reported in an 1890 newspaper article, reports of Caves with 25-foot long stalactites and forests of Gigantic Mushrooms five to eight-feet high having tops two to four feet in diameter !

While there is evidence of beings that exist below the surface that are not cordial or beneficial to surface races (or even sub-surface races) there is evidence that there exists Beneficial Beings in the Elder World...And many secret places exist where they contribute to Surface Race's mental and Spiritual Advancement. Few surface persons are ever allowed Inside except when special consideration is given to such individuals.

Kristie A. Bjork

Dallas, TX.

August 1, 1989

NEVADA AERIAL RESEARCH GROUP
P.O. Box 89180-1407
Las Vegas, Nevada 89180-1407

Thanks for the two back issues of NAR. I haven't read all of it yet, but must write at once. I have several things of interest to share.

FIRST-Yes, send the medical questionnaire.

SECONDLY-Another very strange mark appeared on my arm. Yesterday, actually the day before yesterday it was not there. Yesterday it was on my arm near the junction of the arm and shoulder/breast area. It is like a huge "hickey" like someone sucked the blood right through the skin! I asked a veterinarian at The University of Texas Health Science Center what could cause it. Except for a vit. C deficiency or being abraded or put in a restraint device which was too tight - its a mystery! I suspect it was an alien restraint clamp that caused it. I would send a picture, but I have no camera now right now. I may be able to persuade my boss at work to take a picture of it. If I can - I'll send it at once.

THIRDLY-I know of a possible underground base. A friend and I lived in Waco at the Texas State Technical Inst. for two years. While he went to school to become a dental lab tech. One night we took an excursion around the area and noticed an opening (small) into an underground. It had been filled with stones so we couldn't pry any deeper. I wished to pry into it deeper still, but my friend was not all together gung ho about it, perhaps a little bit afraid. We had a UFO sighting over the old air strip. This school used to be an Air Force base. Two brilliant red objects hovering for at least a half-hour over this strip. My friend swears he saw only one object. I also saw an oval gray thing fly over the area and later heard a bunch of helicopters over this area quite often. They were too far away to be able to see if they were unmarked.

When I was living in Irving, Texas I saw a huge boomerang shaped object gray with a yellow/orange forcefield around it and it was noiseless. It flew straight for the Naval Air Station. This was in the summer of 1982 at 11:00 p.m. While I was living in Irving again in 1985 I would see military helicopters fly over the apartment daily. These had no I.D.'s that I could see. I tried to photograph them, but there just was not any detail.

FOURTHLY-Animals: I clean surgery rooms, feed animals, clean cages and assist the health techs. who are vet. assistants. I often

August 1, 1989

Page 2

I often have to help restrain animals, especially roudy dogs & fastidious cats. I stock the surgery rooms with medicines. I also clean the bathrooms, stock them with paper towels and toilet paper & what not. I have to go to the physical plant to get towels and T.P. I answer phones in the lab, and clean the lab. I run various errands especially for one lady who has me take payroll computer forms to the payroll dept. I also take blood samples /fecas/fur plucks, etc. to the diagnostic lab.

So far I have not been able to get many regressions done. I feel extremely uneasy about doing so, because the aliens have given a totally assured go ahead, but at the same time I feel that they might have said something very important with repercussions.

About the FBI inquiry. This info. about their asking if I had engaged in sex with aliens. This was asked of a friend who is also a friend of Simone. I do not know for sure if this is the truth. However, I suspect this is in keeping with the FBI. In other words, it sounds suspiciously like a game of theirs.

Things I'd like to see mentioned in the book. One aspect - the nature of the realms or planets these beings are coming from. I'd prefer to see a whole lot....correction...I prefer to see not a whole lot of channeling. I have studied channeling and I think a lot of it is full of B.S. I wrote the channeler who channels Bashar, and I never heard from him/her. A lot of B.S. - cataclysms, frequency changes in to the fourth dimension, etc. These are areas that not even Jesus Christ could answer - remember he said, "Only the Father knows".

I realize a lot of aliens like to play the know it all game, but as soon as they bring this stuff up - I turn off & tell them to change the subject. I prefer info. about astronomy, X-Ray Stars, black holes, etc. Also, propulsion units, etc. I realize they also give out some B.S. about propulsion. I realize the reason why is for their own protection. Can you imagine the repercussions (what the repercussions) would be if the aliens gave out the secret of walking through walls? Why all the crooks, rapists, thieves would build their own transporter belt and commence to ransack everywhere! No, they will hold their technology. It is truly frustrating to be stuck here on this primitive world. I have to make the best of it until they evacuate us people who are more spiritually advanced or reincarnate into an advanced civilization. I don't have much high hopes here either.

At the present, I do not know the looks of a hybrid child. That is one of those things I do not remember at all. It may be that I wasn't that interested. I am just not regressed to this episode. I do feel that I may have a clone somewhere. Most likely in an underground base. The entities in the underground base struck me as either being like zombies or just concentration deeply on what they were doing.

August 1, 1989

Page 3

Oh - Oh! Here's some data that indicates a subconscious interest. When I was about four years old, possibly five, I was being tested due to determine if I had a behavior problem. I was constantly playing and/or creating mischief. I was given a Rohrshock (sp?) inkblot test and an M.M.P.I. They had a room with all sorts of odds and ends set up. They said, "Do what ever you feel like doing". Immediately I got up and grabbed a paint brush and put some black ink on it. I then painted an oval black thing on the wall! That's all I would do.

Later, as a child of eleven, twelve or thirteen I was obsessed with drawing underground bases. I did this for hours. I had a weird fantasy at age fifteen (aprox.) I'd lay on a table in our base-ment and fantasize a big reptilian human laying its webby hands on my face. At the age of thirteen I flew in a jet out to a cousin's house in L.A. I stayed with them for a month. My cousin and I would sit and draw unceasingly - at first it was jets and then we got a kick of drawing futuristic planes. They would always look intentical to flying saucers, however, I never considered or realized totally what I was drawing.

To continue - Today I took a short excursion down to the first floor of the animal resources center. I took the freight elevator down. Somehow a mistake was made. I ended up in the subbasement. I just got a quick glimpse of what looks rancid indeed. There was cement there and dirt. I did not get to stya to explore because I was working at this time. I shall look further on my lunch break. As soon as I get to explore I'll write and report what I see. It may be one of these instances where the right hand doesn't know what the left hand is doing. I suspect this is a case of being so hidden and unknown that they neglect tight security. I may get to get some pictures of this. I am not really scared of these aliens and would find it rather humorous to catch them unaware. Awhile back, say six months, for several days in a row a suspicious helicopter kept flying directly over & around U.T. Southwestern. It seemed to be hunting for something or someone. It looked like a civilian helicopter, but it did not have any markings on it. It was blackish or gray, but it was not a typical looking military helicopter. I counted the times the helicopter circled. It was seven times!

I just got the MUFON Symposium proceedings. In it are two excellent papers. One is by Stan Friedman on MJ-12. The other is about a government/coporate coverup by Robert Oechsler. These two articles go a long way in making this whole government coverup look highly plausible. I suggest if you don't already have it, that you get it in posthaste.

I'm a member of MUFON Metroplex. Our next speaker will be Bob Oechsler. I have written him already. I plan to meet with him sometime during the meeting.

August 2, 1989

Page 4

I have sensed that the government isn't the only ones covering up. I get the foul impression that most of the humans on this planet do not wish to ever face the fierce fact of visits by ET's

I have many examples. One for now. About six months ago I had a big UFO book in my arms walking into the cafeteria. I was suddenly joined by a nice looking lady (about twenty-eight years old). She asked if she could share a table and discuss UFOs. I said sure. The discussion immediately took a negative turn. She did most of the talking. She said point blank that ET's do not exist. I asked why? She said, "Because of the Bible". I do not remember the complexities of this conversation because of the shock of such a negative idea. She could only accept my UFO sightings (of that boomerang) as being a government vehicle. Instead of arguing with her I laughed and got up and left.

I have only found one person out of loads who is at least open to the idea of ET visitations at U.T. Southwestern. The rest are denying the possibility in their own puny/mundane ways.

I am enclosing some literature from various veterinarian supply houses. Particularly take note of the small animal cage made out of plastic in part of the literature I'm sending you. It looks very similar to the shoebox like things the Alien fetuses are grown in. Perhaps one of these suppliers are selling the "shoeboxes" unwittingly to the Dulce Lab, ha! I'll send you the address of one of these suppliers later.

I truly enjoy reading your publication.

Sincerely,



UNDERGROUND ALIEN BASES

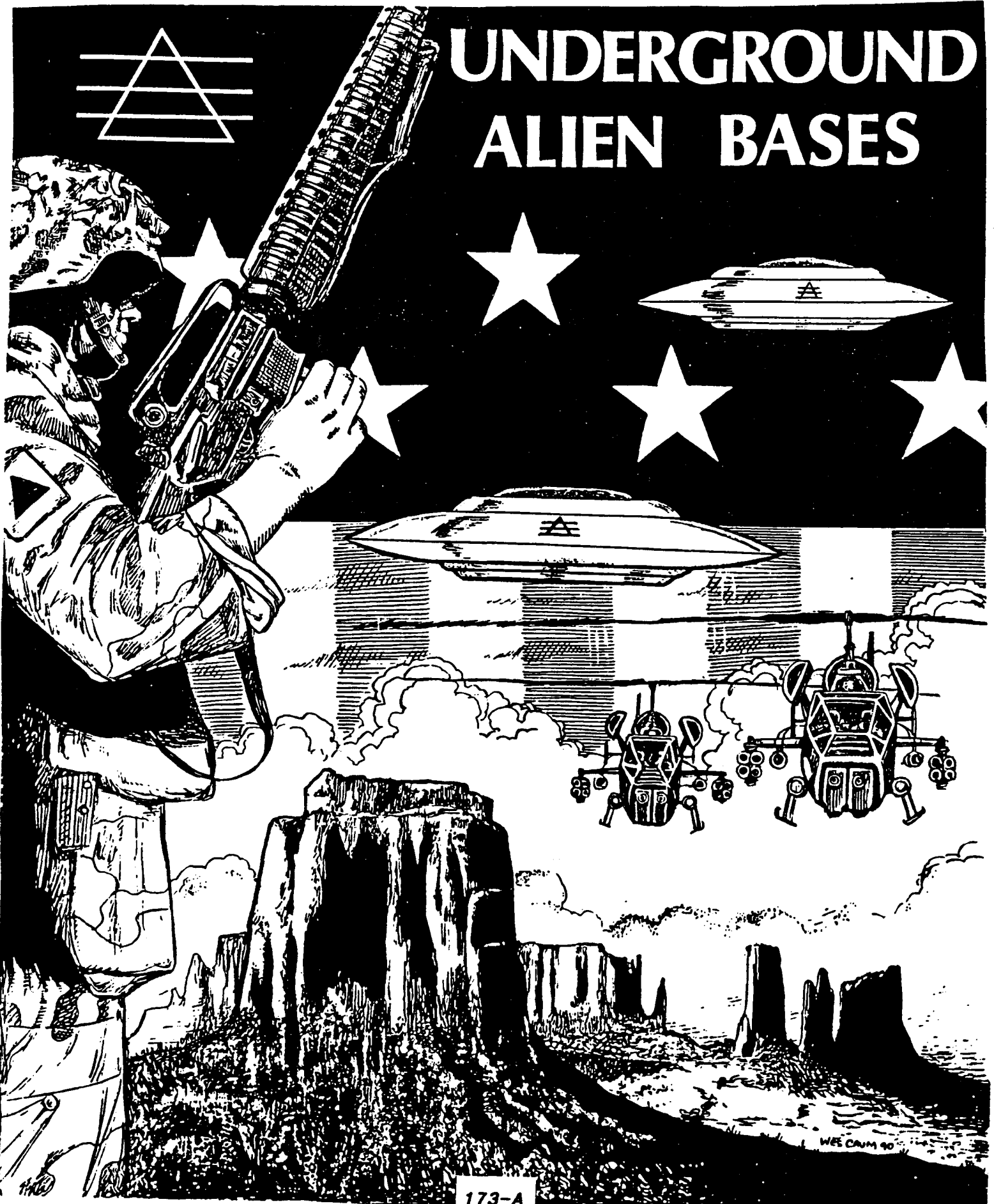

**Underground Alien and Joint Use Facilities
for Alien Reproduction, Humanoid Cloning
and the Manipulation and Control of Human Beings**

The research community was rocked in November of 1989 when EG&G scientist Robert Lazar expounded on his employment at site S-4 on the Nevada Test Range, telling of anti-matter propulsion systems, gravity amplifiers, and the involvement of a small number of scientists, who worked under a totalitarian security system. The testimony of Lazar appeared to augment the testimony of other individuals who work in Nevada, some of whom have spoken of underground tunnel systems and facilities. Underground facilities also appear in a significant number of cases where individuals have had interaction with forces that are considered to be non-human in origin and intent. November 1989 was also the month that researchers related the results of investigation into the concepts of Space Law. Researchers reasoned that since the concept of Space Law is valid and legitimate, then the experts in Space Law must have written something during all these years. Researchers found that there are documents which appear in books of Space Law that appear to be treaties - treaties which distinguish between groups of individuals on the surface of the planet and groups that work below the surface. The theme of underground installations pervades virtually all areas that have been examined by researchers.

With the assistance of abductees and researchers, we have come up with locations for tunnels, entrances, and base areas. There are more locations than are listed, and the information base on this subject grows weekly. Underground bases shall hereafter be referred to as (UB). Many of the bases appear to be run by entities, NH or otherwise, that are totalitarian, domination-based, military and elitist in nature.

Intelligence about the various species that are interacting with this planet is plentiful within intelligence and security agencies. A significant amount of data has also been gained from employees that have worked at these UB, people who have been abducted by government forces or NH forces and taken there, and research efforts of scores of investigators around the planet.

Although there are scores of UB of various descriptions, there are two major installations which seem to be mentioned quite frequently: Dulce, New Mexico and Groom Lake, Nevada. Data about these locations generally seems to apply to other underground installations, planetwide, other than underground living facilities occupied by some groups of human entities which are the remnants of previous surface civilizations. A good many of these groups are peaceful and apparently have no intention of interaction with either surface humans or NH, or covert UB that are occupied by humans or NH.

The subject of bases, both above and under the ground, manned by either human military or alien forces (or both), is a constant factor that is reported by individuals who state they have had experiences involving their involuntary abduction by alien beings. That these

places do exist is beyond question. Abduction reports from widely varied sources preclude the possibility of collusion among people. The sheer weight of synchronicity and corroboration indicates that the experiences are beyond the idea of coincidence.

It appears that having facilities under the ground is commonplace among technically advanced species, presumably because they would want to remain hidden from forces that might endanger their continued existence. It is also a factor of keeping ones' actions hidden from the mass populace on the surface of the planet. After years of study, it has become quite apparent that the radiation on the surface of planets is detrimental, and that underground existence is much more desirable. It is known that the concentration of soft electrons under the surface of the ground is much higher, and that this greater concentration promotes biological lifeforms to a greater state of health.

Many of the underground bases are adjacent to large underground cavities, many of which are known by both the public and the military forces. All large underground cavities affect the gravitational field strength in that area, and they all can be located through an examination of a Gravity Field Anomaly map obtained through the US Geological Survey. The average field strength is about -100 to -150. The field strength over these large cavities seems to vary from -250 to -400. Check it out. Relate these areas to areas of sightings. Viola!

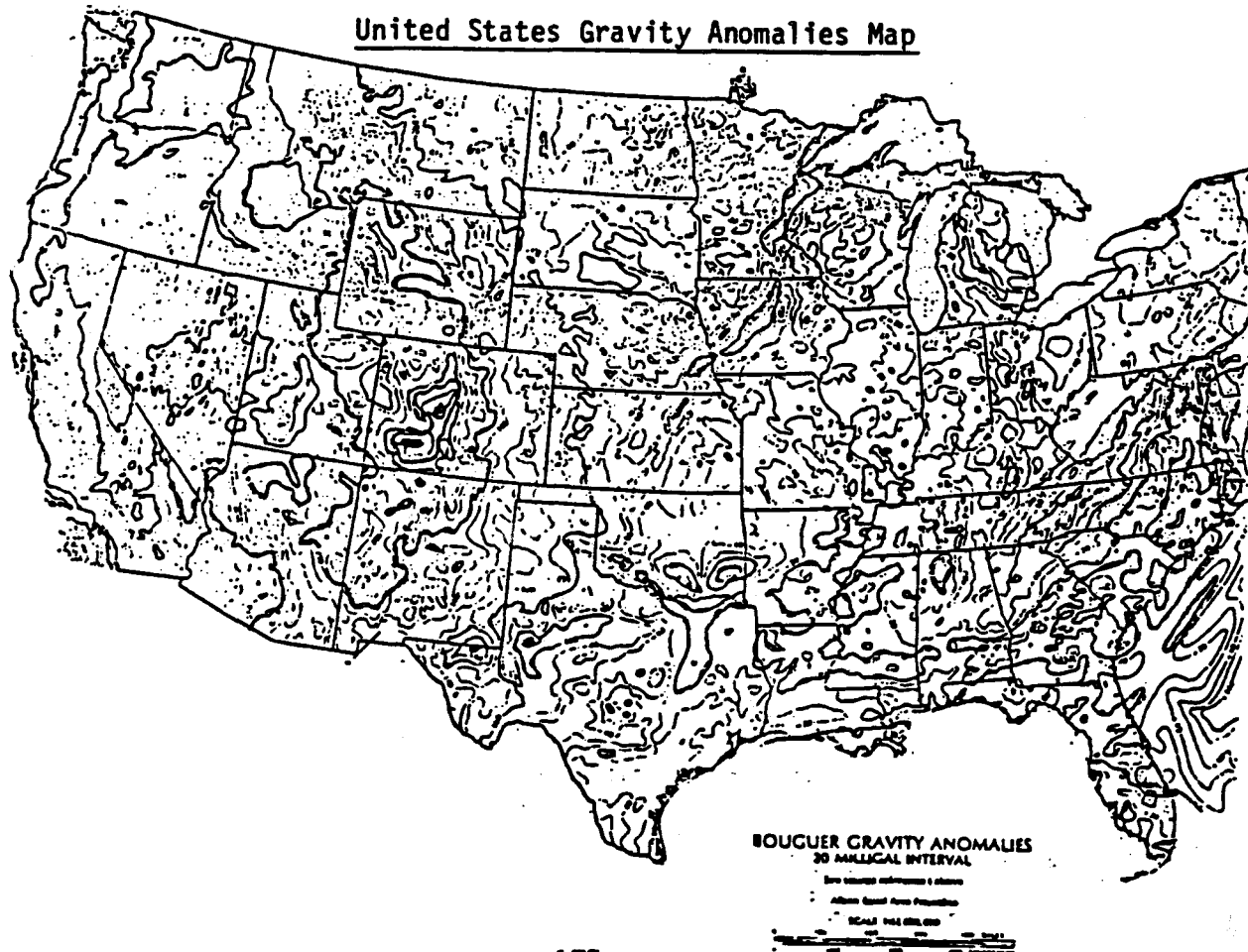

ABDUCTEE REPORTS UNDERGROUND FACILITIES

MEXICO AREA

1. Magdalena- UFOS spotted frequently
2. Ceballos-Pueblito de Allende- underground facility & lab
strong anomaly area, UFOS seen nightly
3. Durango-UFOS spotted north and anomaly area connects with Ceballos
4. Coahuila- area where most of these anomalies and UFOS are spotted
5. San Ignacio Hill-Secret underground laboratory
6. Quimica del Rey-Chemical plant N.E. of San Ignacio Lab

OKLAHOMA

1. Ashland-underground tunnel and UFO sightings
2. Idabel- UFO sightings-recent
3. Valliant-UFO sightings recently
4. Tahlequah-UFO sightings, strong anomaly area
5. Nelogany- UFO sightings, Bigfoot sightings, Strong anomaly or
window areas experienced by me personally, Black helicopter crash
6. Turley-North Tulsa-Cattle mutilations, UFO sightings
7. Kiefer- UFO sightings, abductions and anomaly area

ARKANSAS

1. Foreman-UFO sightings
2. Texarkana-UFO sightings, Bigfoot sightings
3. Berryville-Cattle mutilations, UFO sightings, strange deaths of
people there who investigated mutes
4. Eureka Springs-Strong anomaly area-possible underground tunnels
5. Hardy & Cherokee Villiage-Strong anomaly area, crystal mineral
mines and underground areas

We have some sensitive areas in Kansas just reported. Wichita-UFOS seen, military black helicopters seen. Also a report from a military man from Ft. Riley. Has seen UFOS and not been allowed in certain areas of the base. Talk of UFO abductions of military men & their families. Cannot confirm this at this time because the man and his family suddenly disappeared. My best friend of over 15 yrs. has not contacted me since they reported the information to me! So Kansas is definitely a concern for me personally.

Also in Nelogany, Oklahoma- I experienced strong electrical fields and met with an old woman who claimed her husband and her would drive down this stretch of road every week and a craft would hover and follow them to the next town and then on return to Nelogany. The night I investigated this case, I went to this area. I had never been there. There were four female investigators and we got lost and saw an old tavern. We stopped and went in and there were what looked to be rednecks drinking beer and playing pool. When we walked through the door, they immediately stopped and looked at us as if we were from (outer space) Sorry for the pun. Anyway, I spoke up and told them we were trying to find Nelogany and got lost. Then one huge cowboy of a guy said these exact words, "You all are looking for"...then he stopped and pointed up towards the ceiling. We immediately began asking about the UFO sightings. He stated they were there all the time and it is commonplace. That night after I spoke to the little old woman who had had the experience with the UFO following she and her husband, I asked my three friends to drive to the area. It was approximately 8:00 p.m. There is about a 100 foot anomaly area in which strange sounds like beeping (electronic) were heard. Also I had the feeling someone or some thing was watching us. We would walk out of the 100 ft. area and would hear the animals and night sounds. Then walk back into the window area and experience a tingling sensation on our bodies.

All of a sudden I heard a horrible crying-moaning sound from the bushes. We all ran to the car and got the hell out of there. I taped the beeping sounds and after the experience, we discussed the whole evening. The people were strange. Not afraid of strangers and freely gave of information. They seemed to know what we were looking for and did not hesitate to give information. This is strange as I, being a resident of Oklahoma most of my life, know people of Oklahoma seem to keep to themselves alot and are not too friendly in small towns. They kind of stick together. Later that evening, upon returning to Bartlesville, I became very ill with severe diarrhea and stomach pains and head pains. The next day my friends thought they would end up taking me to the hospital, but suddenly the symptoms disappeared just as they had suddenly arrived. When I got back to Tulsa on the news I heard that a black military helicopter on ground manuevers had crashed near Nelogany that same night we were there. The military blocked the area off and would not let anyone in. Said it was a Top Secret mission and they had to clear the wreckage. The area was cleared and never mentioned in the press or on TV again. It was a military helicopter from Tulsa Army Corps. What happened that evening to me will never leave my memory. We believe we heard a Big Foot and experienced some kind of problems(health-wise) after being in this area. I got conjunctivitis and looked as if I had a sunburn. That night we had a period of 2 hours "missing time" and have never discussed it between the other three women since. That next evening Dr. Jacques Vallee, who I had been in contact for some time about my abductions and UFO sightings, called and just happened to mention if I knew where the Nelogany area was! I about fainted! I told him what had happened the previous evening and he said he had heard of many strange things occurring there and went to the area once to investigate some UFO sightings and Cattle mutilations, I believe.

I have not yet had the courage to go back to this area, but plan to go in the Spring. I psychically feel as though I am supposed to go. When I get these psychic urgings to go somewhere, I usually see a UFO and experience some loss of time. A strange area none the less. Will report anything else I hear to NAR as it comes in.

Respectfully,

Christa Tilton
Christa Tilton

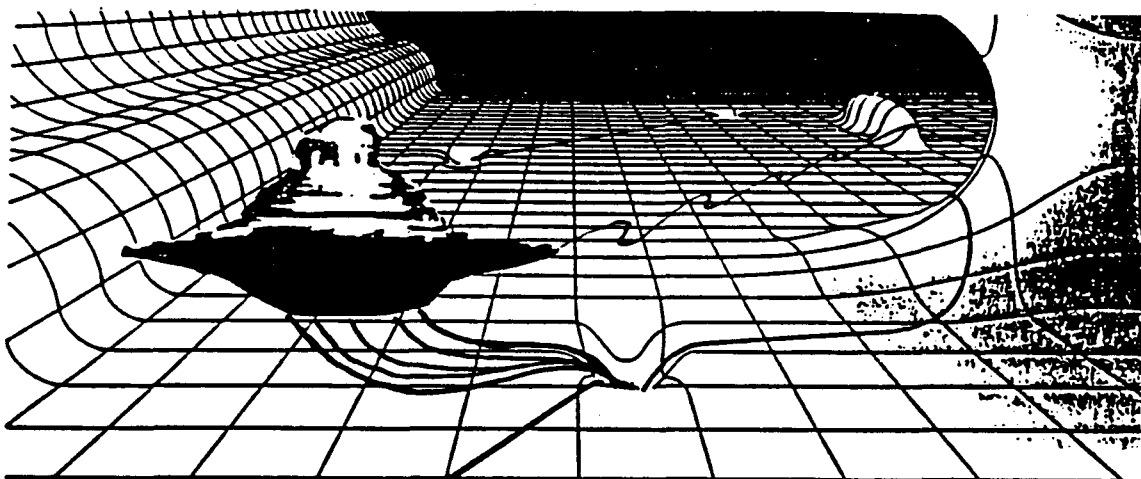

(c)1989 NAR

CONFIGURATIONS OF VARIOUS CRAFT OBSERVED

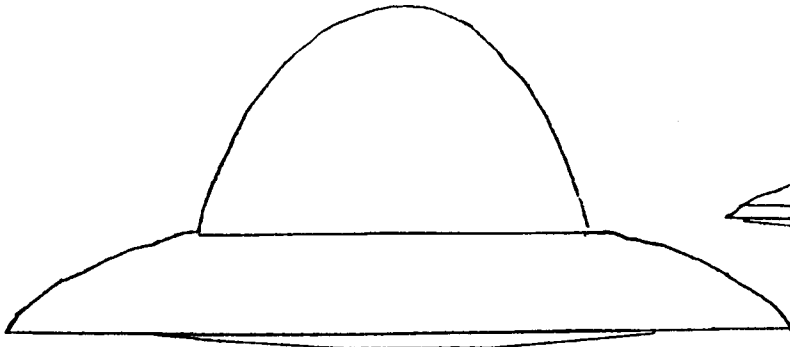

NEW JERSEY - 1952

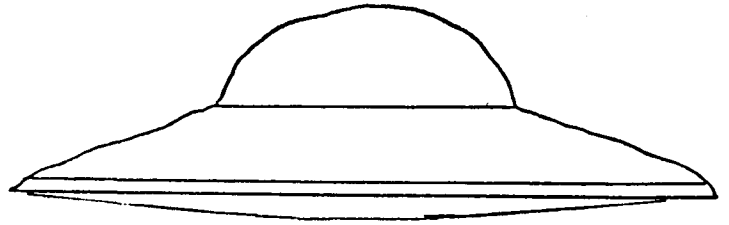

PERU - 1967

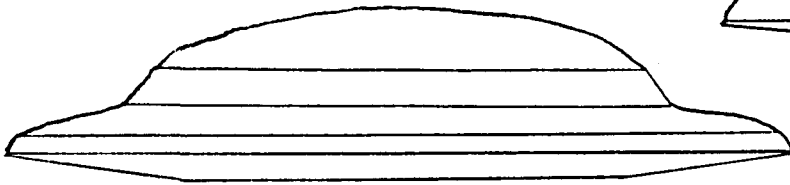

SOUTH AFRICA - 1955

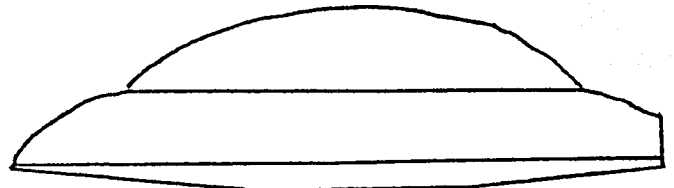

AUSTRALIA - 1967

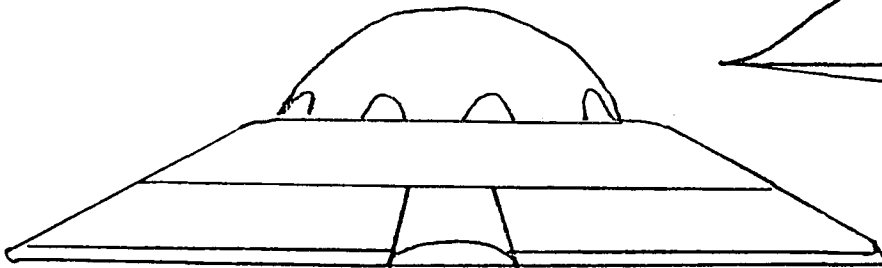

MINNESOTA - 1965

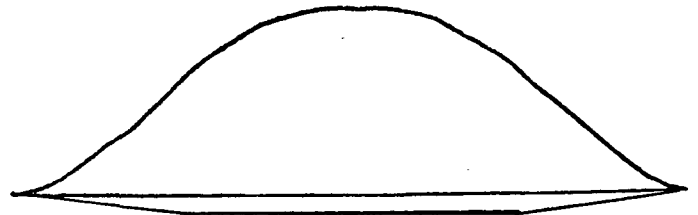

ARGENTINIA - 1970

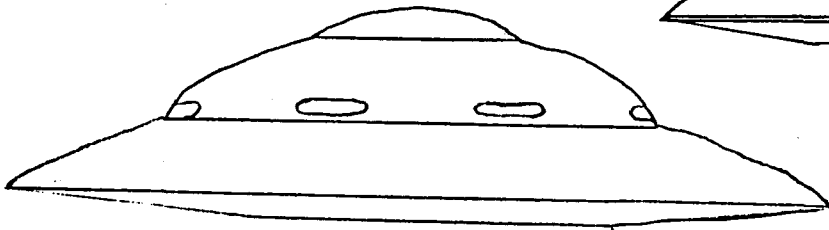

CORSICA - 1971

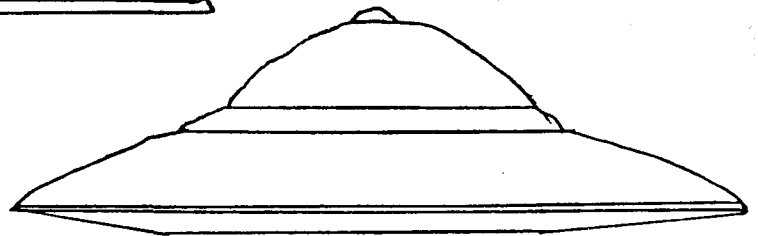

ARGENTINIA - 1974

CONFIGURATIONS OF VARIOUS CRAFT OBSERVED

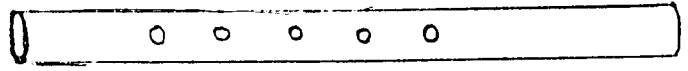

AUSTRALIA - 1960

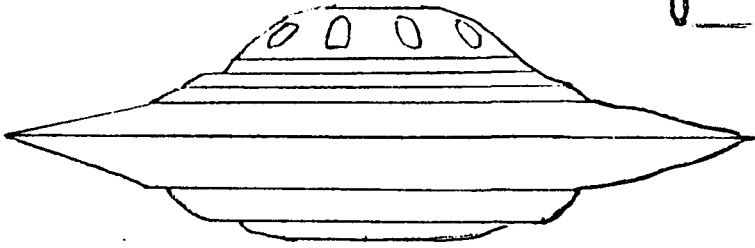

SWITZERLAND - 1975

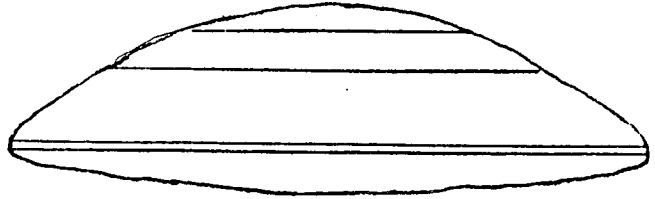

AUSTRIA 1971

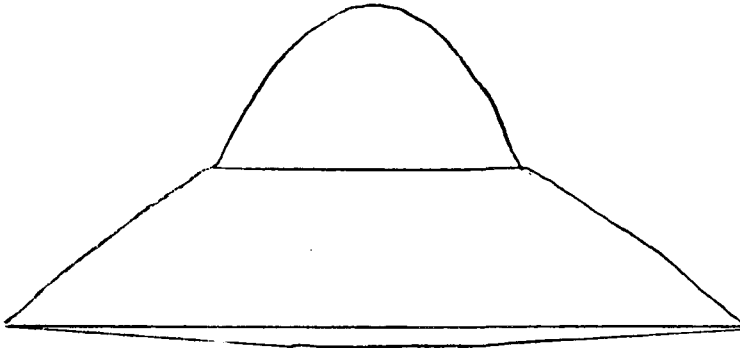

COLUMBIA - 1971

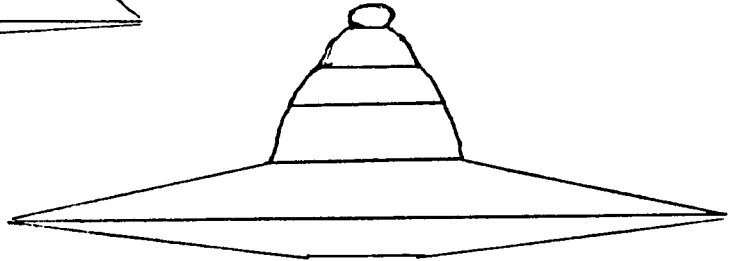

ARGENTINA - 1977

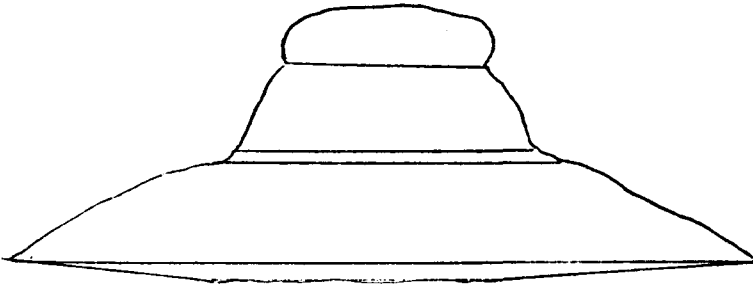

INDIANA - 1977

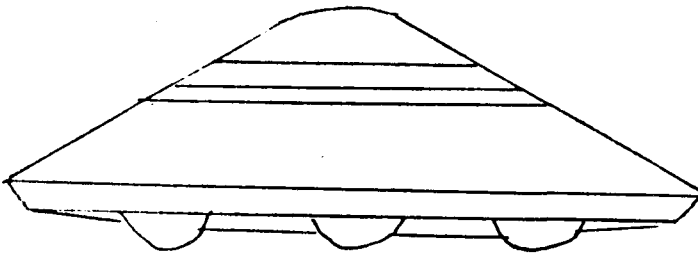

MISSOURI - 1957

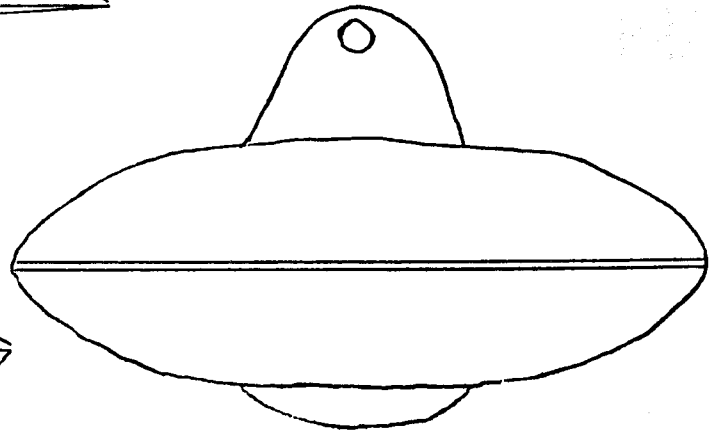

BRAZIL - 1978

CONFIGURATIONS OF VARIOUS CRAFT OBSERVED

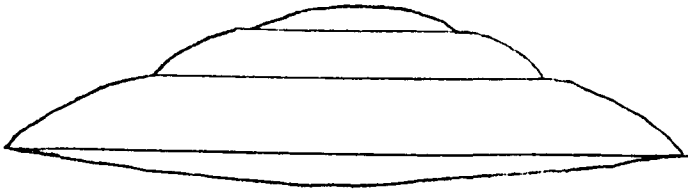

ICELAND - 1954



MISSOURI - 1957

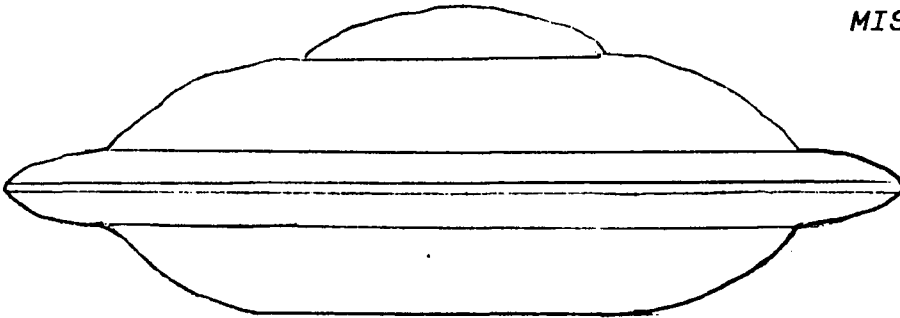

SPAIN - 1967



NEW JERSEY - 1967

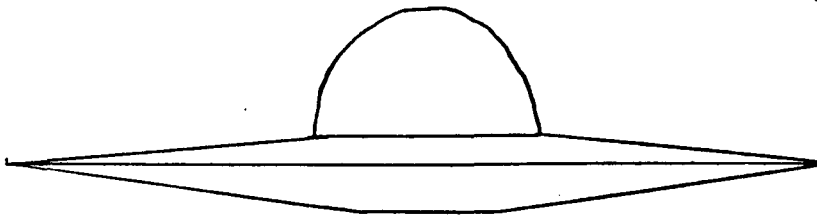

ONTARIO, CANADA - 1975

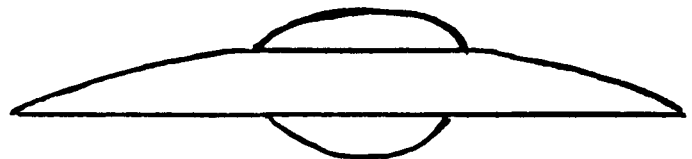

JAPAN - 1962

CONFIGURATIONS OF VARIOUS CRAFT OBSERVED

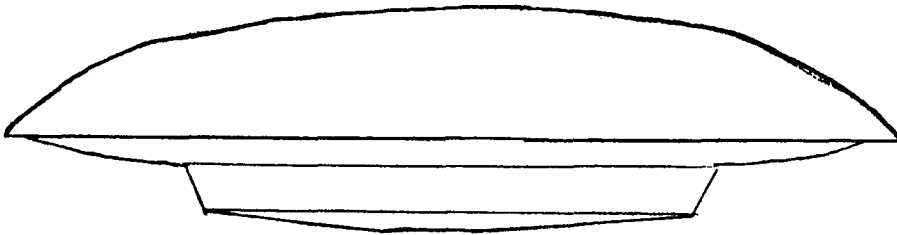

BRAZIL - 1955

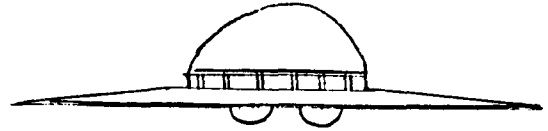

BRAZIL - 1959

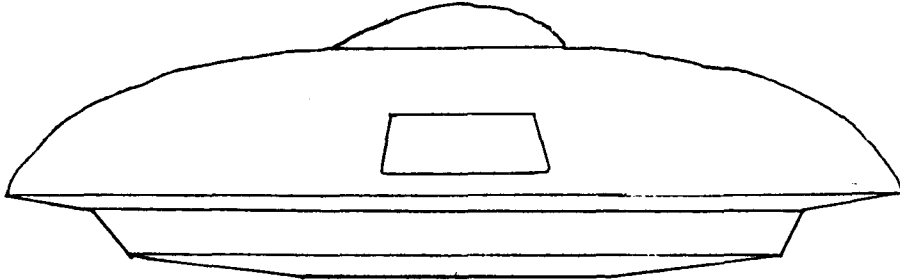

BRAZIL - 1972

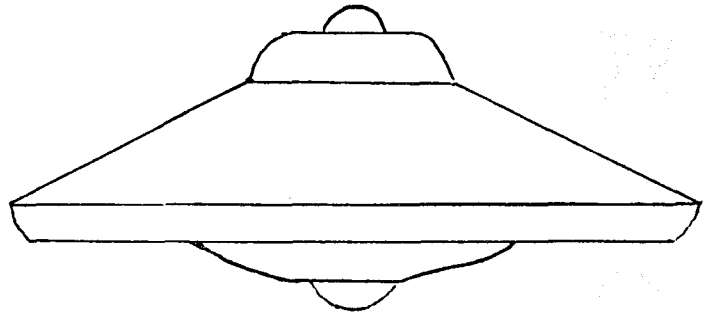

POLAND - 1958

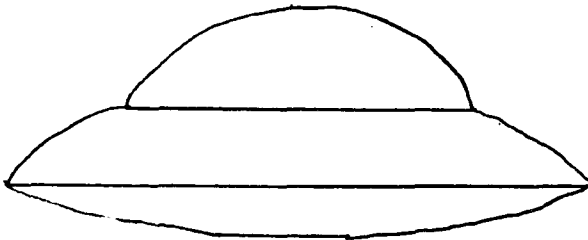

ITALY - 1962

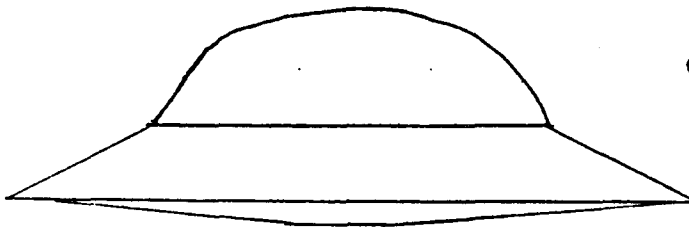

SWEDEN - 1972

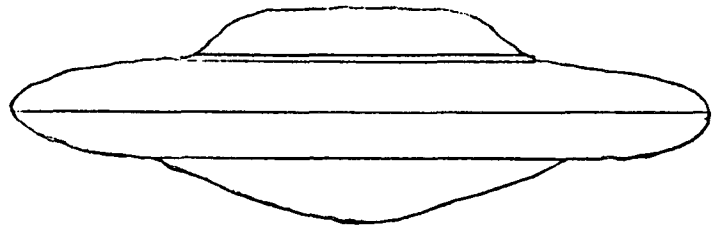

JAPAN - 1971

CONFIGURATIONS OF VARIOUS CRAFT OBSERVED

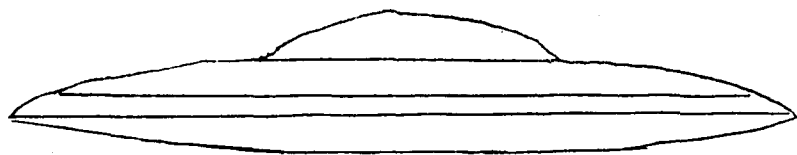

BALKIN STATES - 1972

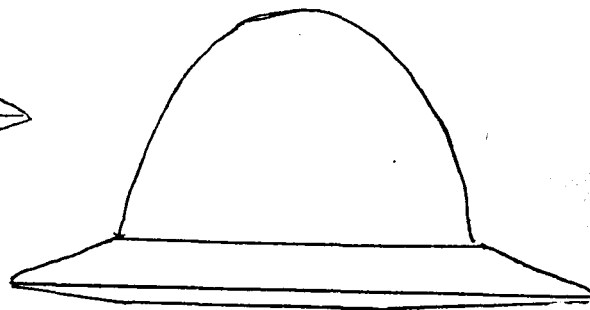

ARGENTINIA - 1967

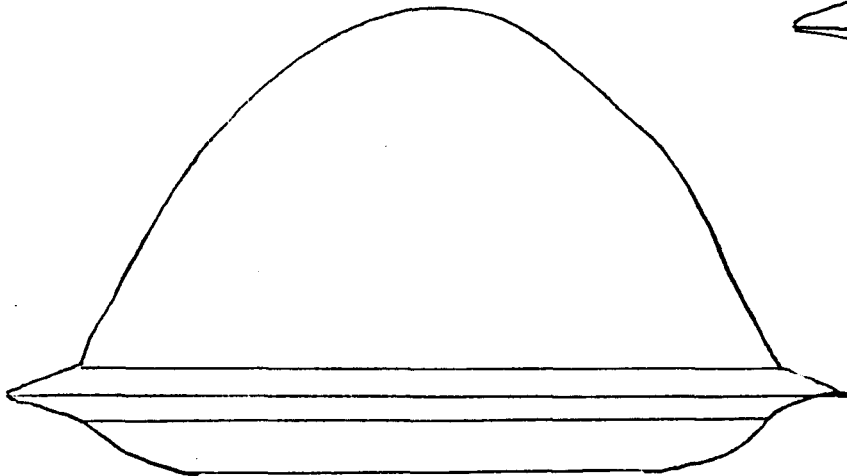

WEST GERMANY - 1973

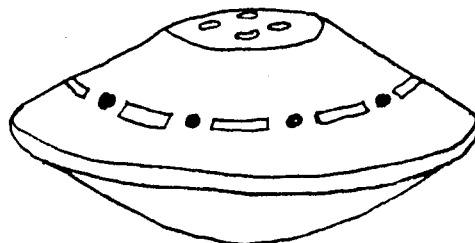

GERMANY - 1942

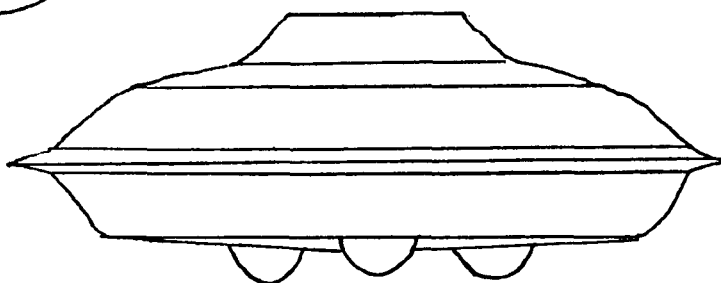

CANADA - 1968

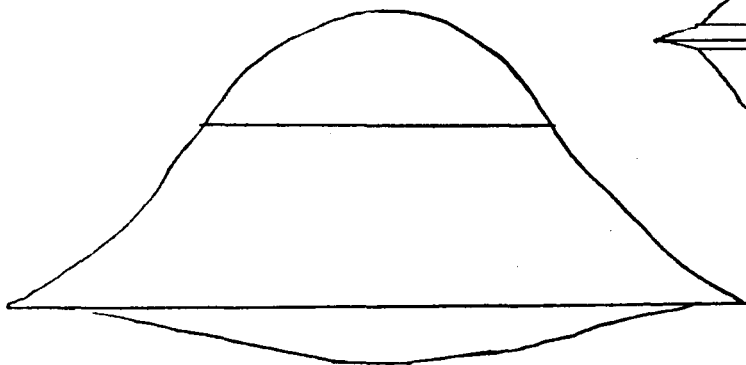

ILLINOIS - 1950

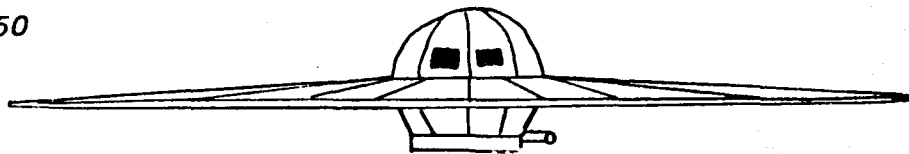

GERMANY - 1945
SCHRIEVER / HABERMOHL 138'

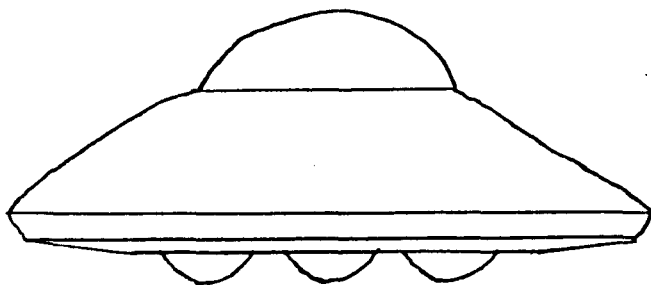

JAPAN - 1975

CONFIGURATIONS OF VARIOUS CRAFT OBSERVED



RHODE ISLAND - 1967
150' "Mother Ship"

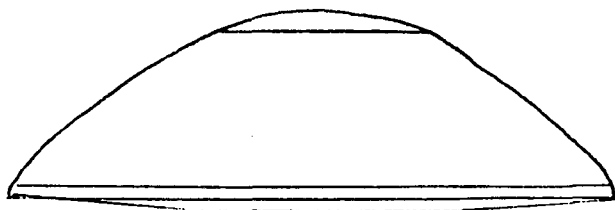

RHODE ISLAND - 1967
"Scout Craft"

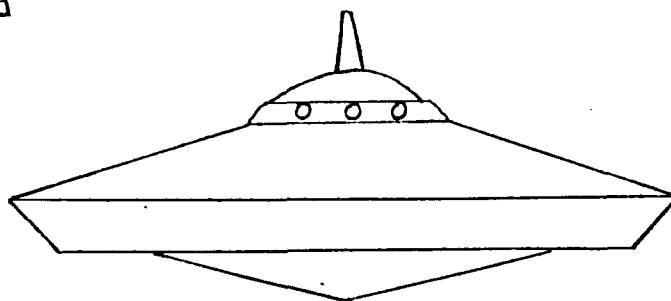

RHODE ISLAND - 1966

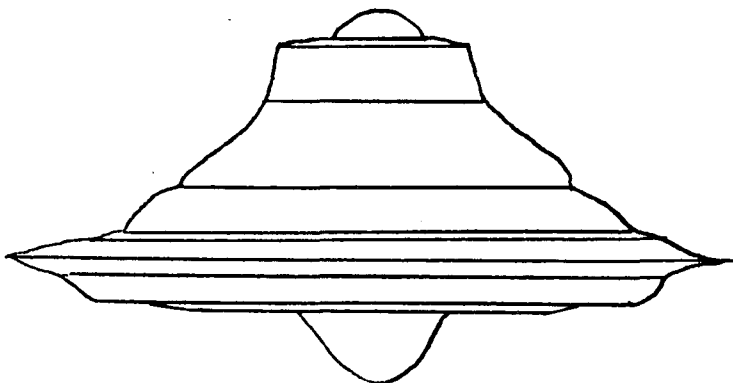

RHODE ISLAND - 1967

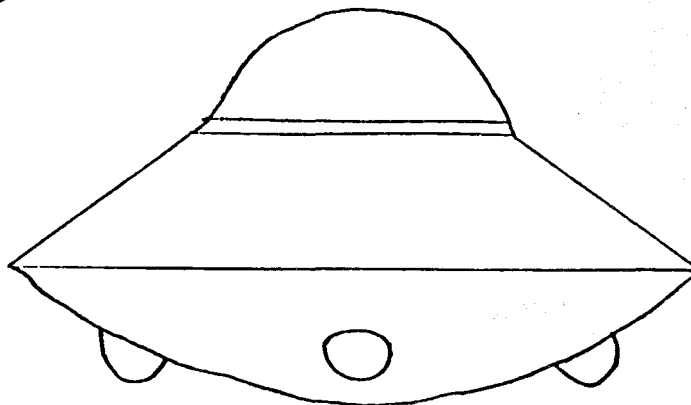

RHODE ISLAND - 1967

Map of United States Mass Anomalies

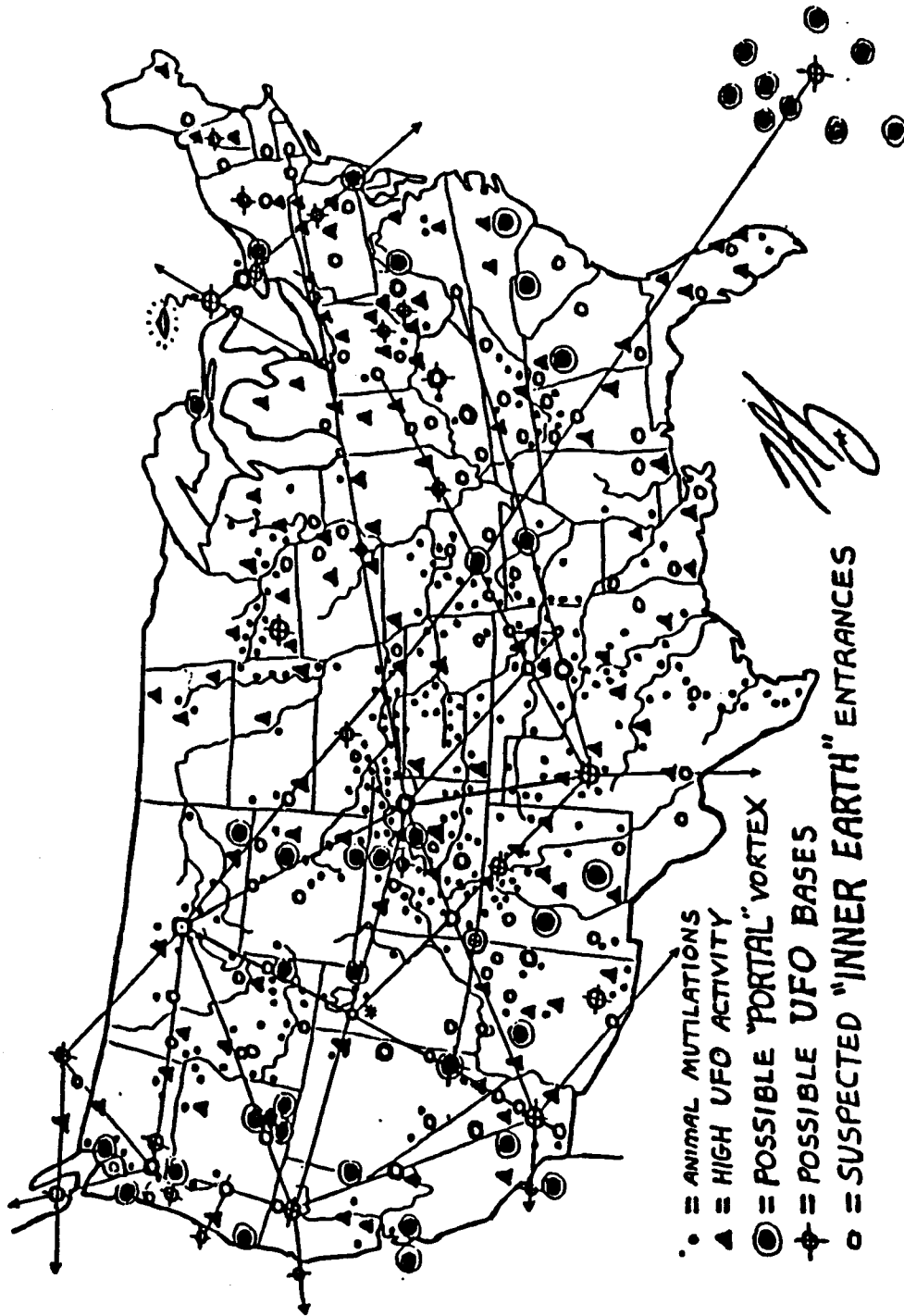

EXPANDED WESTERN TUNNEL MAP

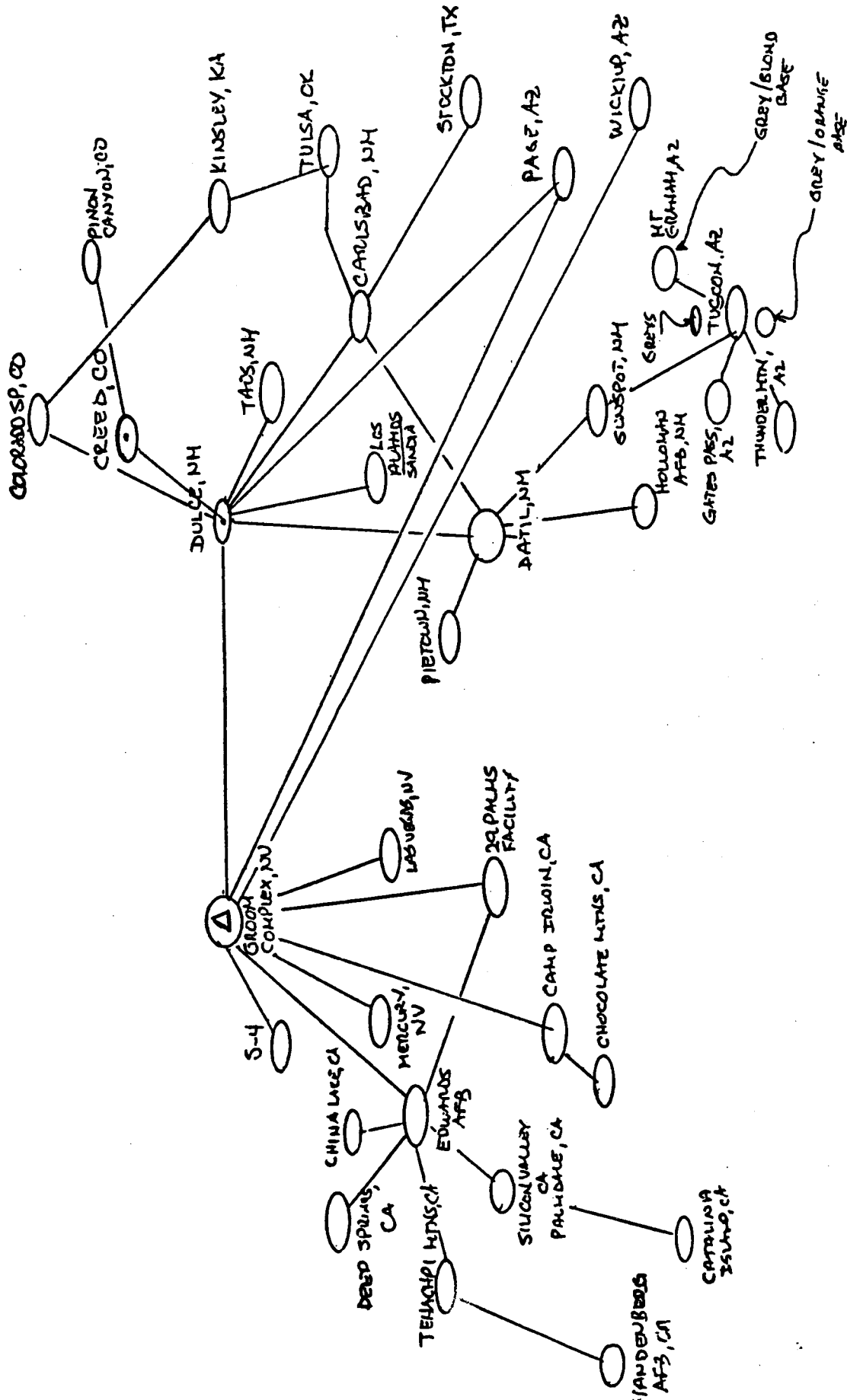

The Effects of Atomic Weapons

PREPARED FOR AND IN COOPERATION WITH THE U. S. DEPARTMENT OF
DEFENSE AND THE U. S. ATOMIC ENERGY COMMISSION

Under the direction of the
LOS ALAMOS SCIENTIFIC LABORATORY
LOS ALAMOS, NEW MEXICO

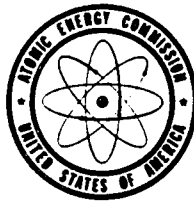

Revised September 1950

BOARD OF EDITORS

J. O. HIRSCHFELDER, *Chairman*

DAVID B. PARKER

ARNOLD KRAMISH

RALPH CARLISLE SMITH

SAMUEL GLASSTONE, *Executive Editor*

For sale by the Superintendent of Documents, U. S. Government Printing Office
Washington 25, D. C. - Price \$1.25 (paper bound)

12.28 Certain structures, which are concerned with essential industrial production or are used for important military purposes, will demand special treatment. Each of these installations may require individual consideration, with particular evaluation of strategic, tactical and logistic factors. In such cases, maximum protection may be required, making *complete underground placement* desirable.

12.29 *There are apparently no fundamental difficulties in constructing and operating underground various types of important facilities. Such facilities may be placed in a suitable existing mine or a site may be excavated for the purpose. The terrain should permit horizontal drift access with adequate cover.*

SOUTHERN NEW MEXICO: UNDERGROUND BASES REPORTED

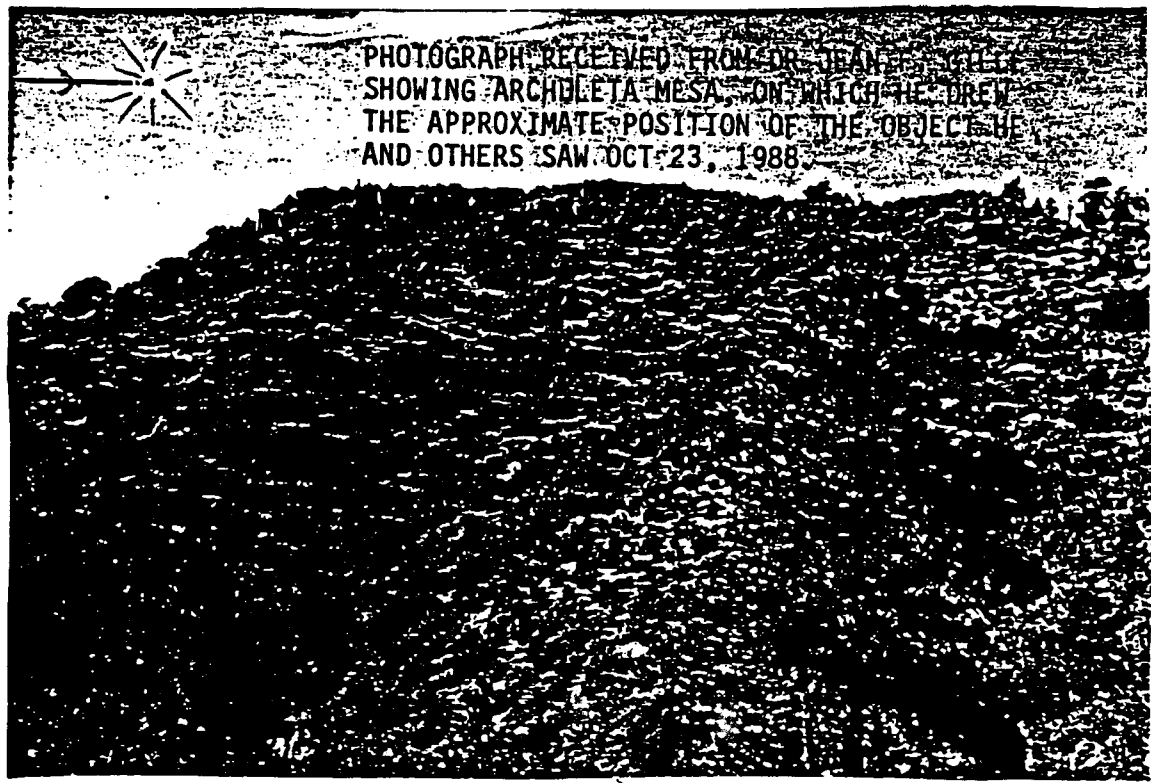
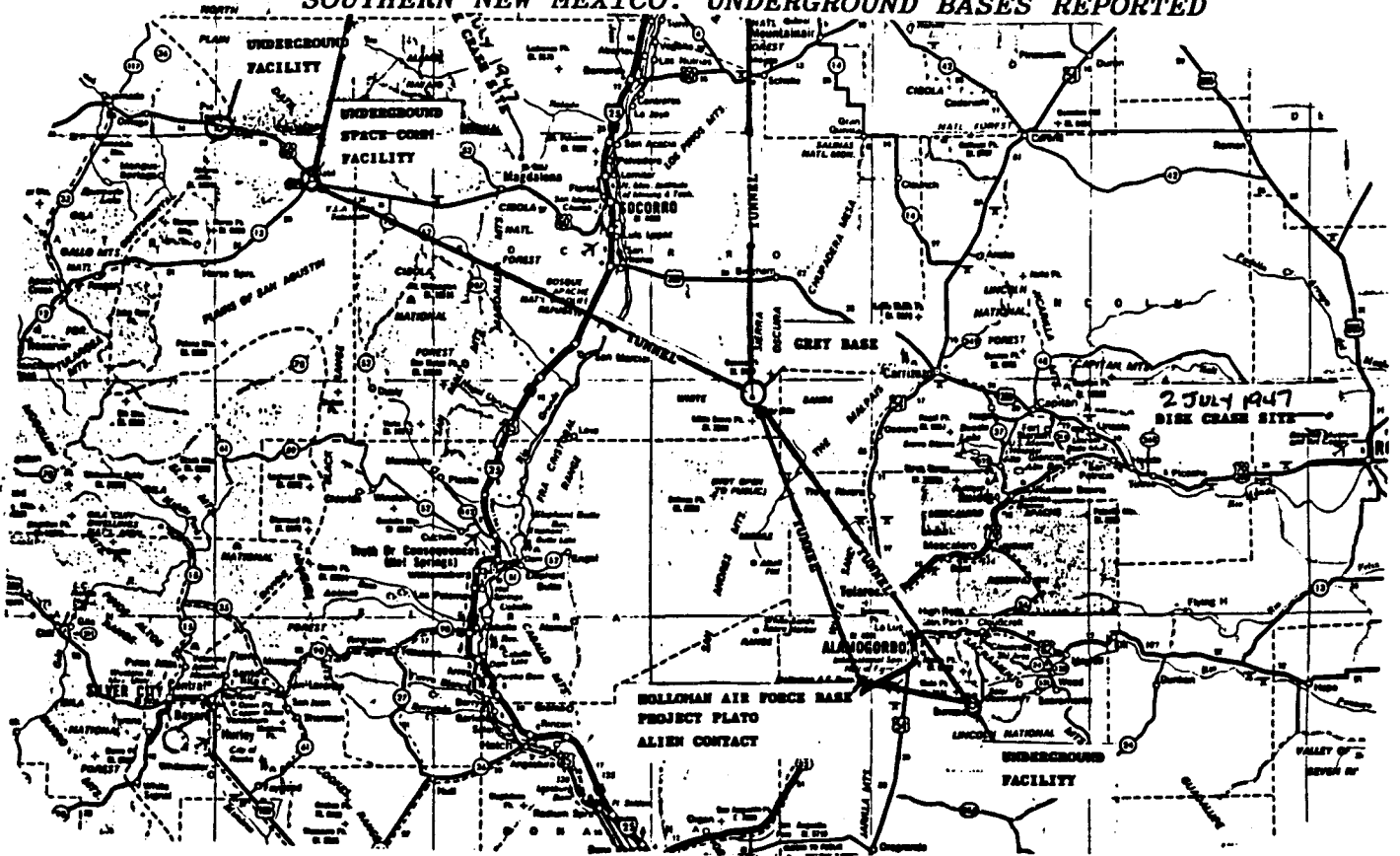

PHOTOGRAPH RECEIVED FROM DR. JAMES GILBERT
SHOWING ARCHULETA MESA, ON WHICH HE DREW
THE APPROXIMATE POSITION OF THE OBJECT HE
AND OTHERS SAW OCT. 23, 1988.

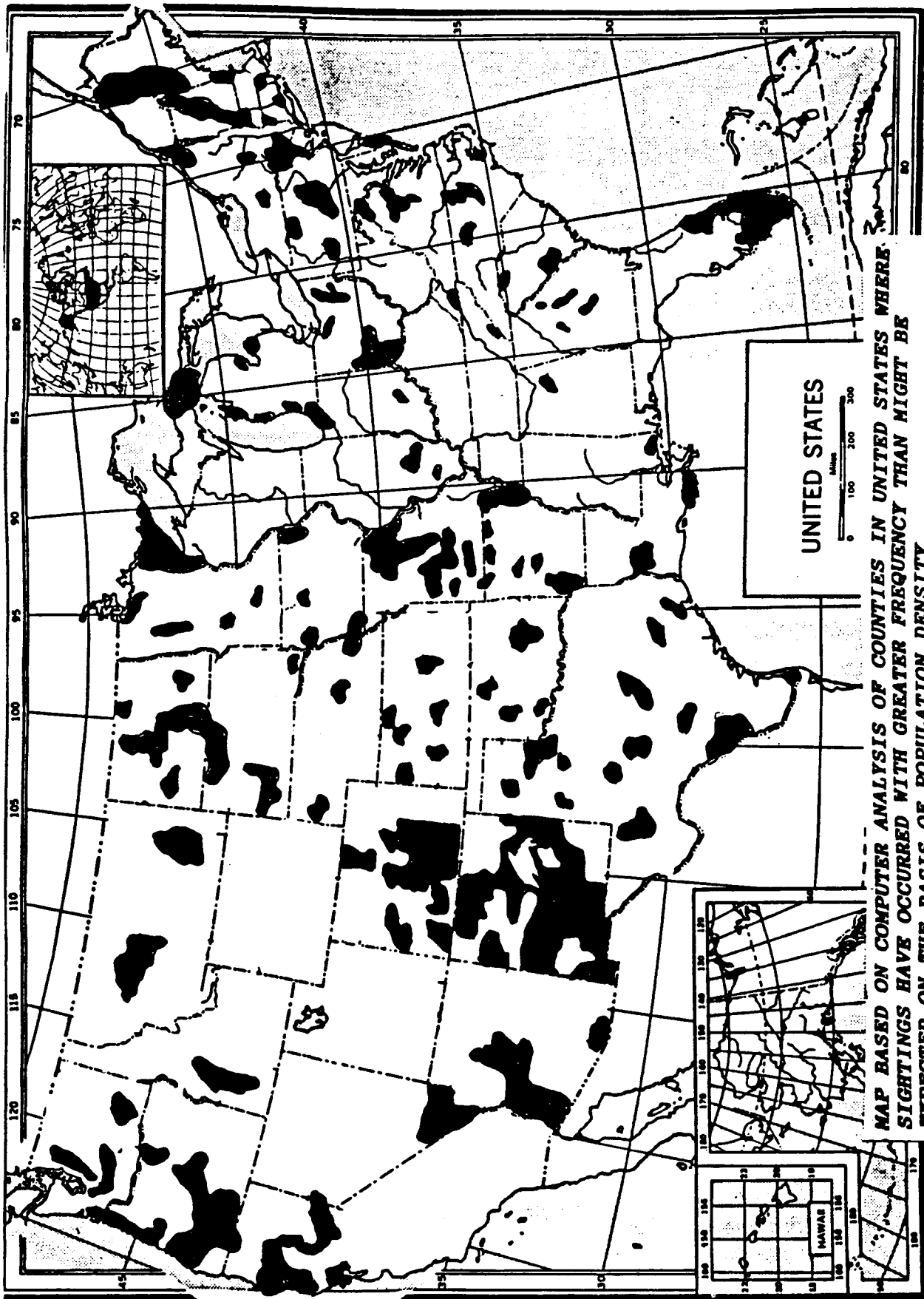

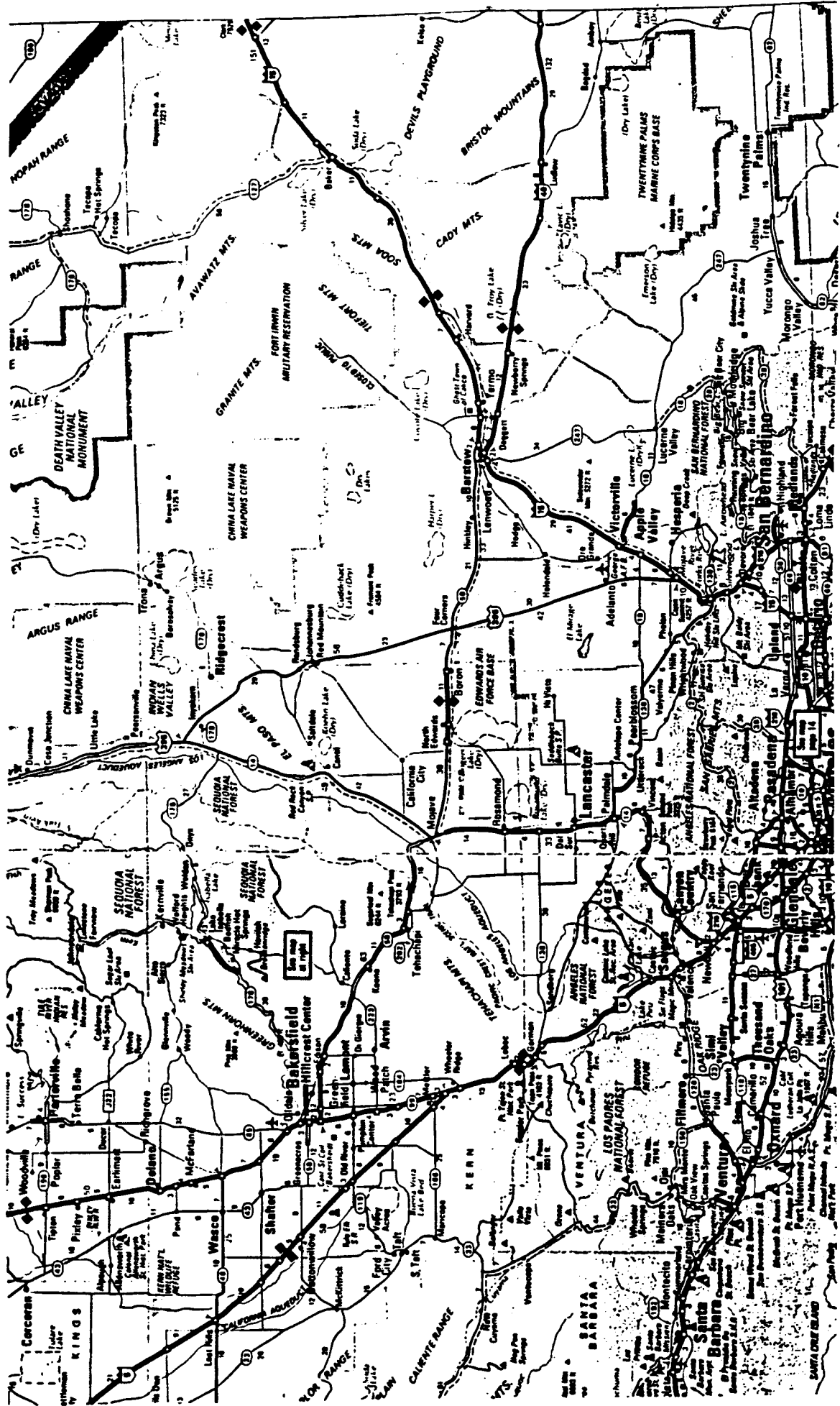

CIVILIAN VIEW OF CALIFORNIA

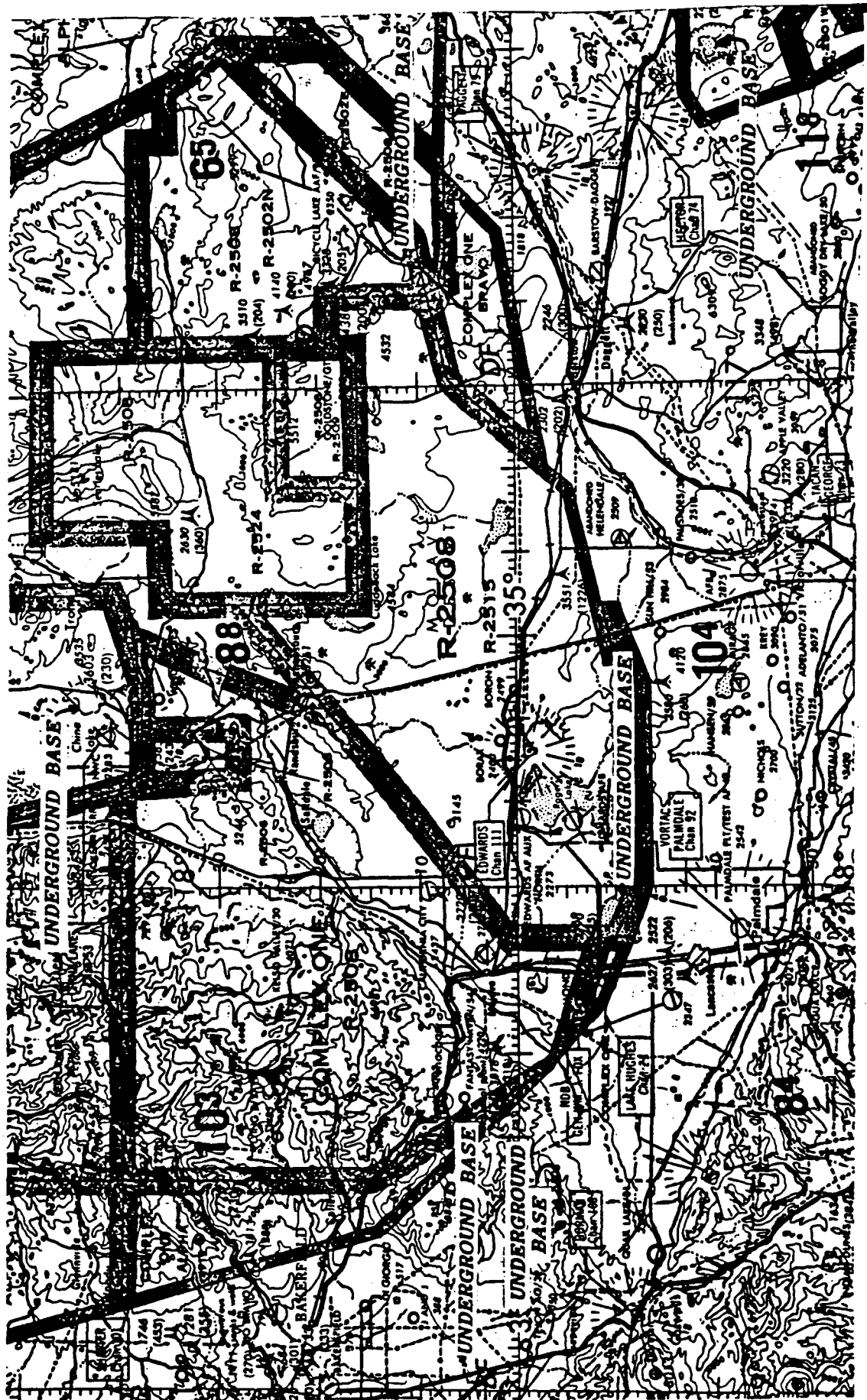

MILITARY VIEW OF CALIFORNIA

MAJOR UNDERGROUND ALIEN-RELATED BASES IN THE SOUTHWESTERN U.S.

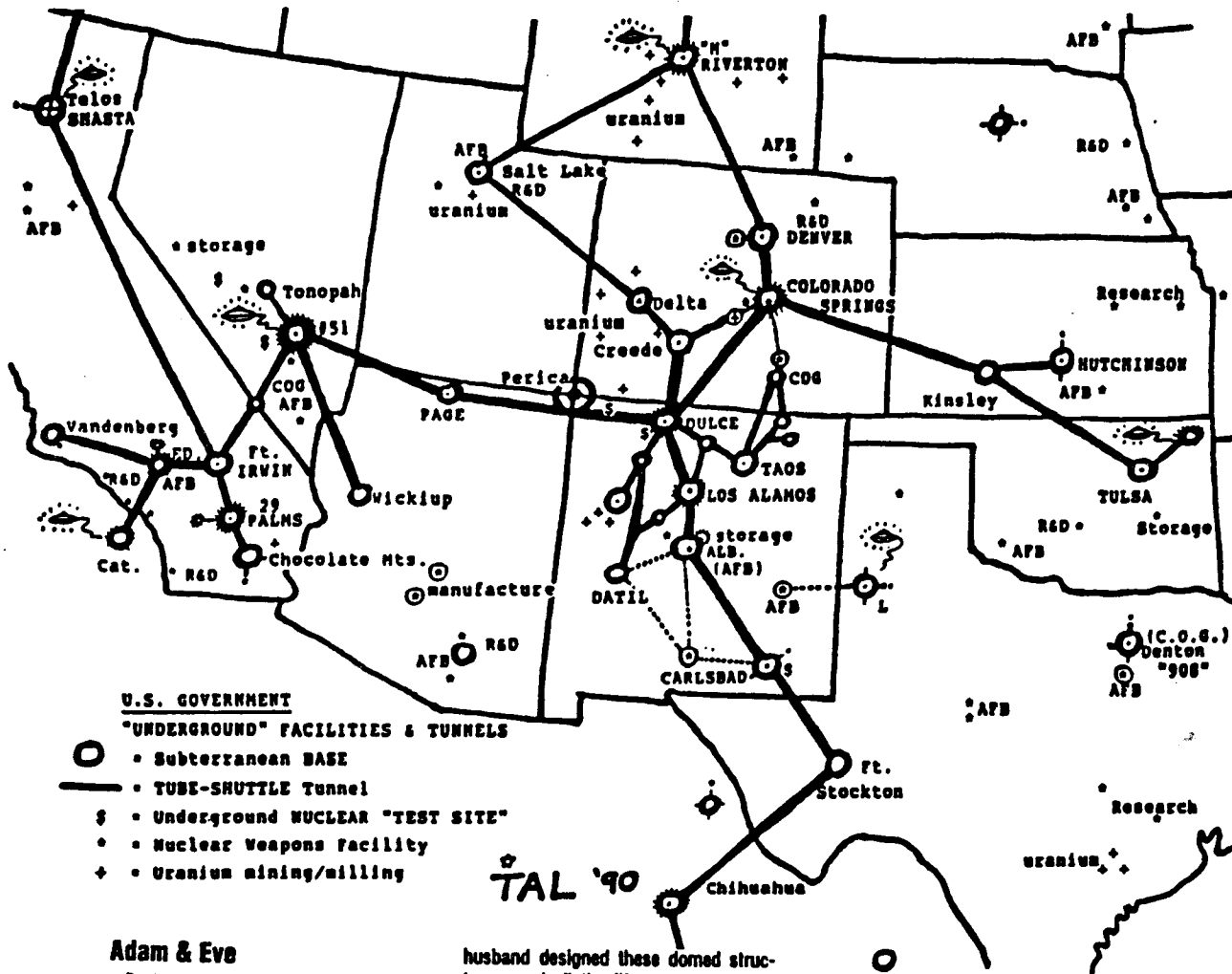

- U.S. GOVERNMENT**
"UNDERGROUND" FACILITIES & TUNNELS
- • Subterranean BASE
 - • TUBE-SHUTTLE Tunnel
 - § • Underground NUCLEAR "TEST SITE"
 - • Nuclear Weapons facility
 - ✦ • Uranium mining/milling

Adam & Eve

Back during 1978 or thereabouts, I happened on a copy of the paperback book, *Alternative 3*, which detailed some of the things my father had told me years earlier, that the military had disc-shaped aircraft. A short time later, on a business trip, I met a woman and tried to impress her by mentioning that I worked as a Congressional liaison to the Pentagon for Nixon's Congressman during the Watergate fiasco, and that my wife had worked as a secretary to Donald Segretti, head of CREEP, in the Naval Annex. She told me she too had worked at the Pentagon, behind the "Green Door", as a cryptanalyst for military intelligence, and personal secretary to an Admiral in the late '50s.

She was offered an assignment in Pasadena in 1962, at the Jet Propulsion Labs there, and assigned to a classified section as a photo interpreter. She scanned all incoming photographs of the Moon and Mars with "high resolution" photography. Her husband, who she met there, worked in another department as a designer. His function was to design domed, modular living facilities for "colonies" on the Moon, and then Mars! The secret name of this amazing project was "Adam and Eve." Her

husband designed these domed structures, and all the life-support systems inside and out. One of their local probes had found gale-velocity winds on Mars, and no other structure would hold up.

Sometime later, her husband and several other key scientists were chosen for an even more secret project, and went off to parts unknown. She never saw him again. When she asked, she was told that his whereabouts were on a need-to-know basis. She got letters from him, but no hint of where he was. One day she was told that he had been killed, but no further information and no body were provided. Then her "Q" clearance was pulled. When I asked her jokingly if she thought her husband had been drafted to go to Vietnam, she stared at me and replied, "No, I think he was drafted to Mars!" And she was dead serious. MJ, El Paso, TX

Robert Salter, of The RAND Corporation, has suggested building a subway from New York to Los Angeles. Magnetically levitated above the tracks, the trains would zip through the evacuated tunnel at speeds faster than an SST, crossing the country in less than one hour. Building such a train presents no special technological problems, but the cost of tunneling from coast to coast would. To be economically feasible, engineers would have to develop a new way to dig. The federal government's Los Alamos Scientific Laboratory, in New Mexico, however, may have an answer to this challenge.

Called the Subterrene, the Los Alamos machine looks like a vicious, giant mole. The beauty of the Subterrene is that, as it burrows through the rock hundreds of feet below the surface, it heats whatever stone it encounters into molten rock, or magma, which cools after the Subterrene has moved on. The result is a tunnel with a smooth, glazed lining. For power, the Subterrene can use a built-in miniature nuclear engine or even a conventional power plant.

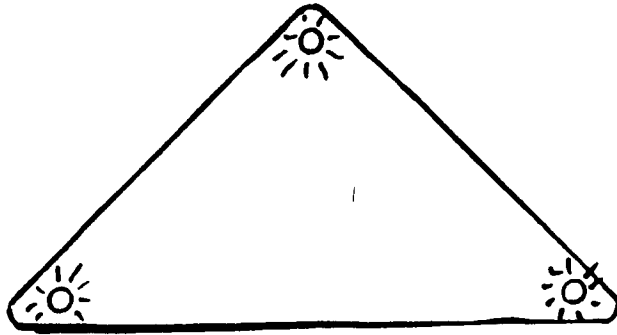

SMALL FLYING TRIANGLE

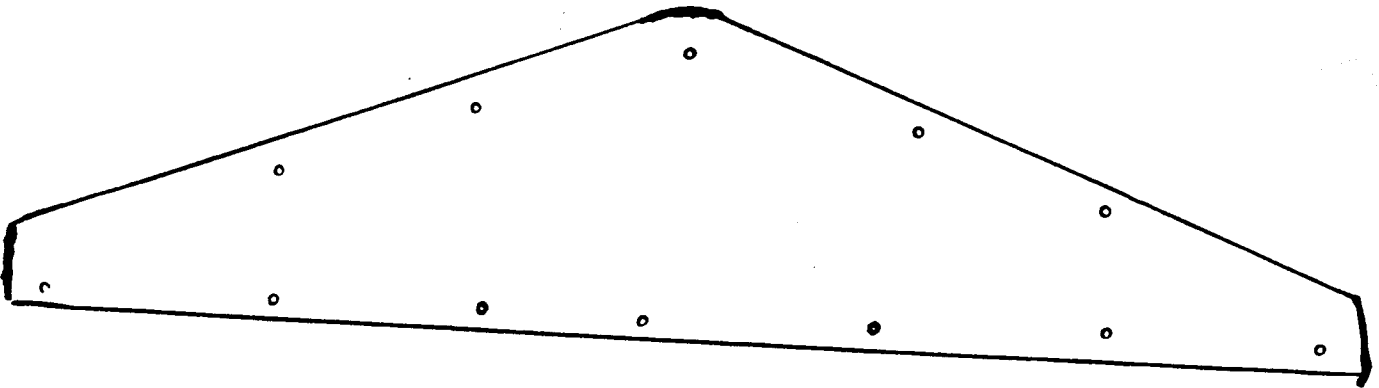

BIG BOOMERANG

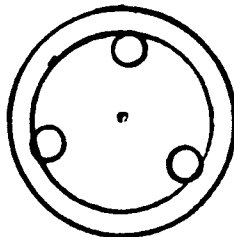

ARV SAUCER

PLANFORMS OF AERIAL CRAFT SEEN OVER THE ANTELOPE VALLEY IN CALIFORNIA DURING 1990 AND 1991, PRESUMED TO BE OF GOVERNMENT ORIGIN.

Mass Gravitational Anomaly Areas of the United States

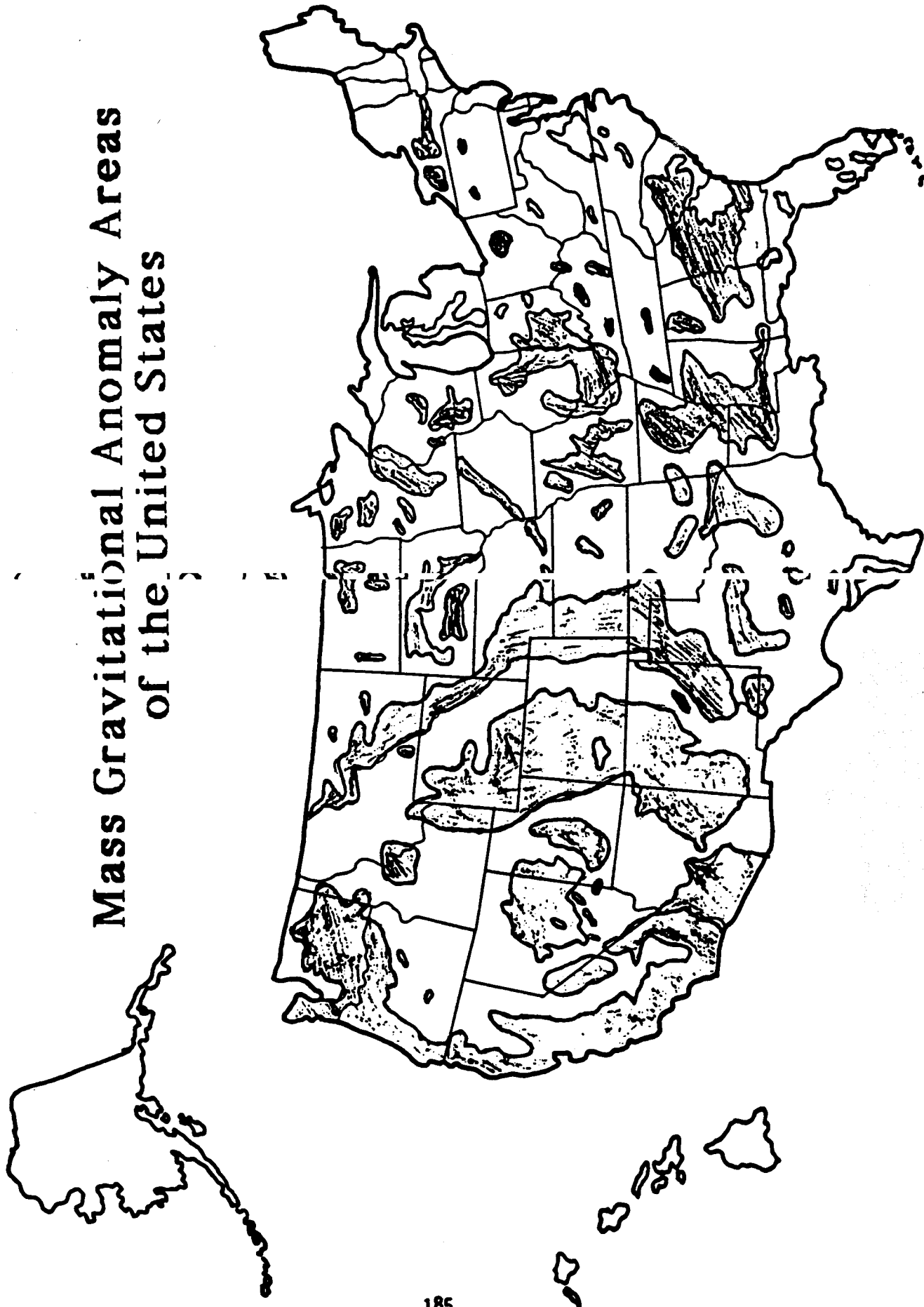

**Areas of Caves and Caverns in the
United States**

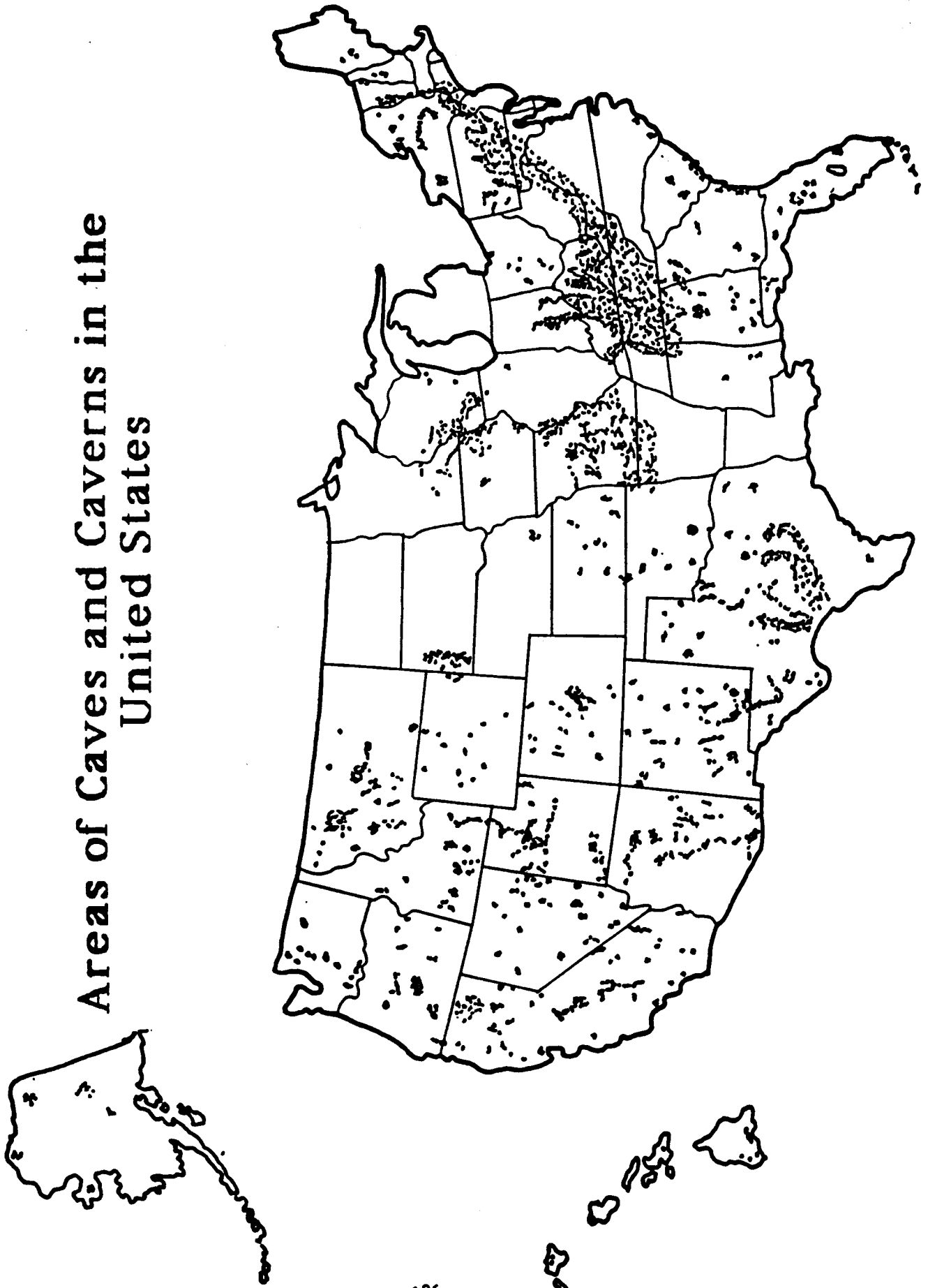

SOUTHERN ARIZONA: TUCSON AREA UNDERGROUND BASES REPORTED

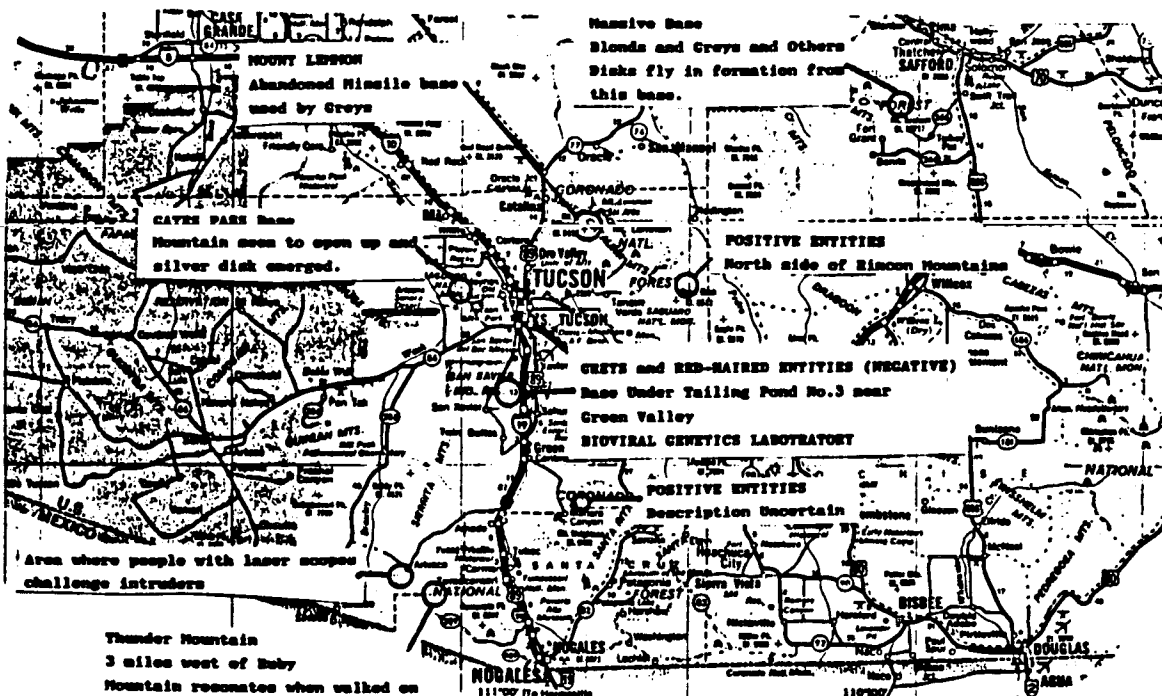

NORTHERN NEW MEXICO: UNDERGROUND BASES REPORTED

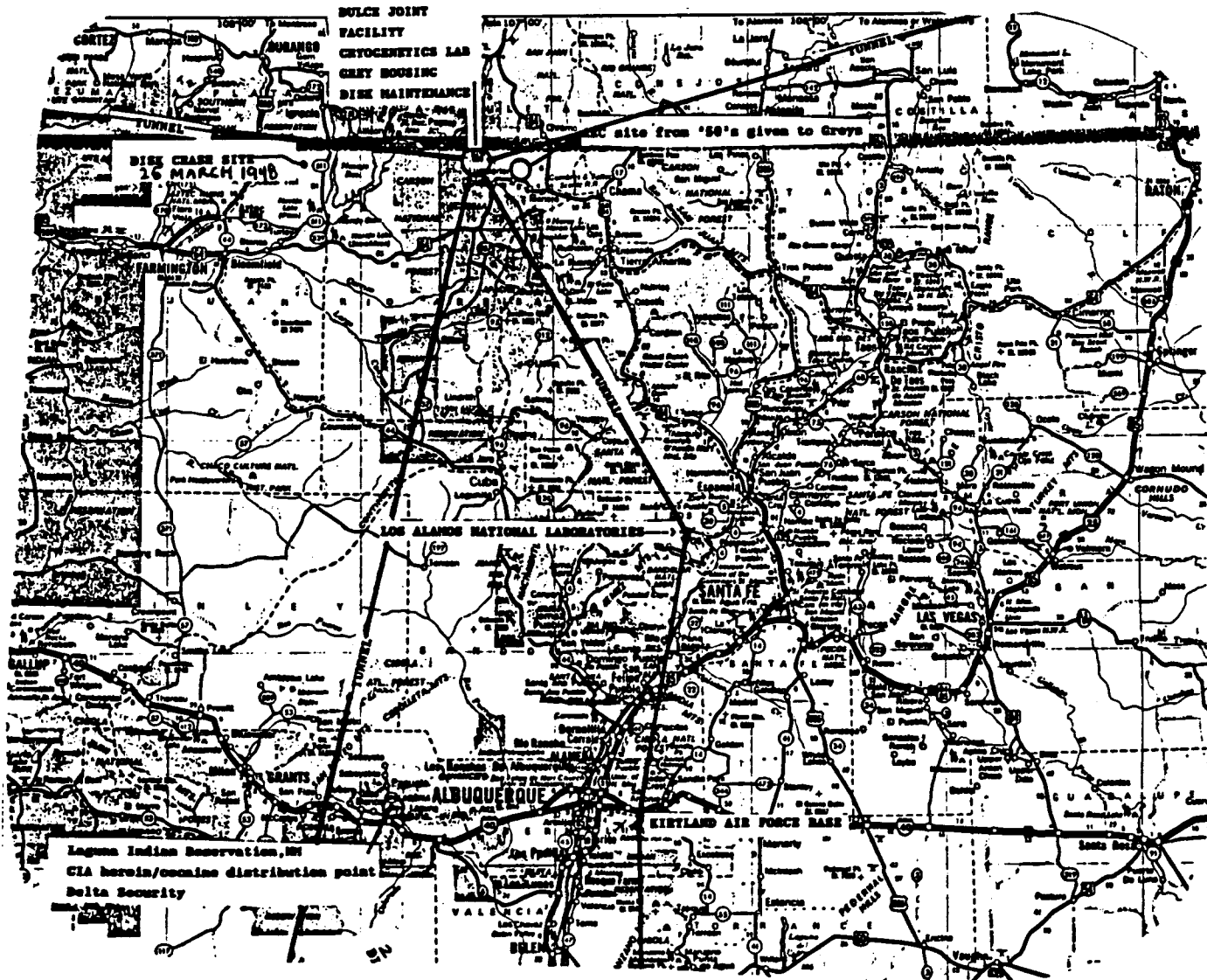

Event Characteristics of Four Corners Area

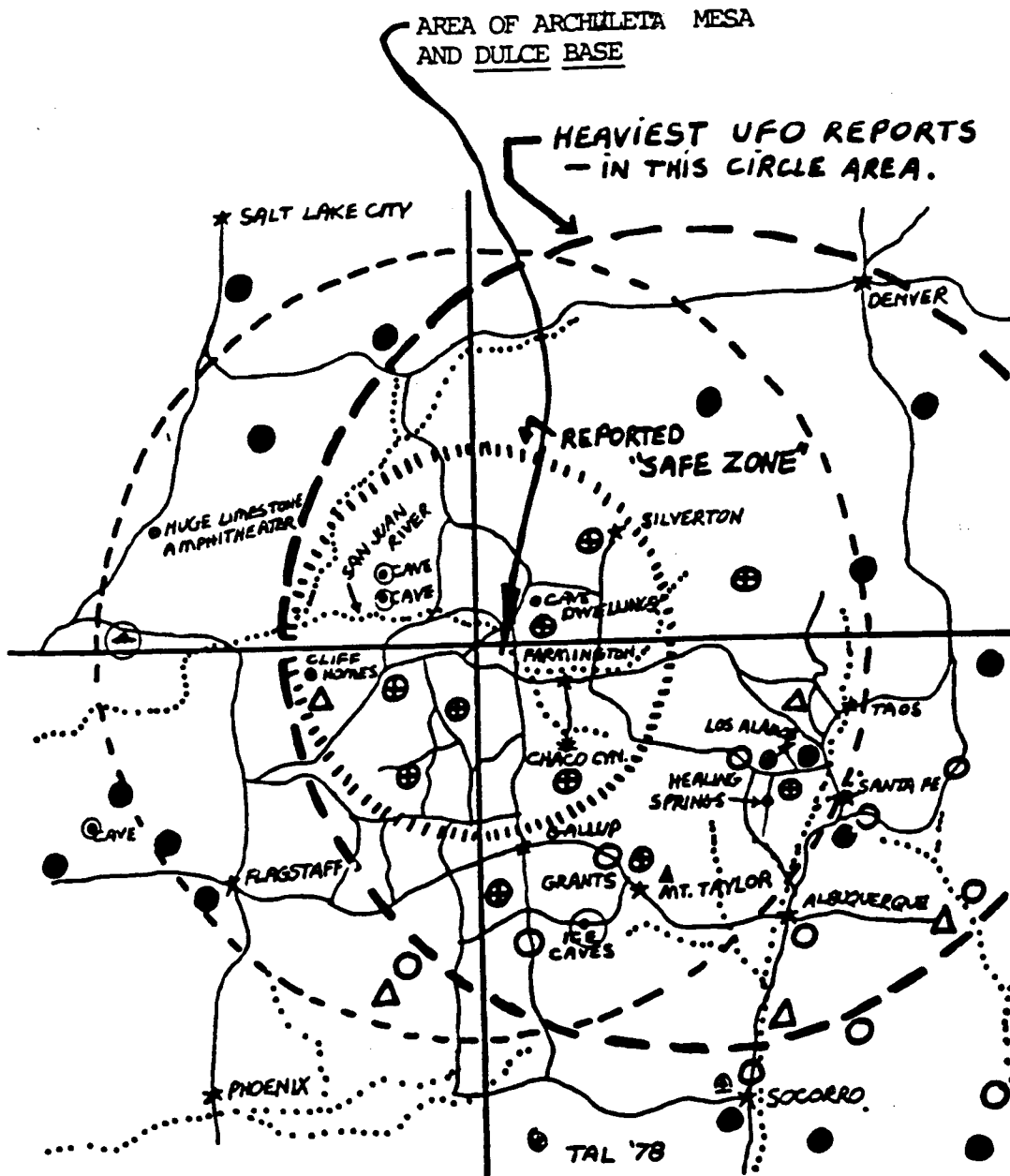

- ELECTRO-MAGNETIC DISTURBANCES BY OVERFLIGHTS OF UFO'S.
- UFO LANDING SITES - WITNESSED TIME AND AGAIN.
- △ UFO OCCUPANTS - SEEN REPEATEDLY.
- ⊕ SUSPECTED ANCIENT TUNNEL SITES.

The Origin of the Dulce Papers

Thomas C. is about 50 years old. Back in his mid-twenties, he received training in photography at an underground facility in West Virginia. For seven years, he worked in high security photography in the Air Force until he was discharged in 1971. Next, he worked for the Rand Corporation in California and was transferred to the Dulce Facility in 1977. He bought a home in Santa Fe and worked there five days a week. Thomas C., like all Dulce personnel, travel to and from the Dulce facility via a deep underground tube shuttle system.

Thomas reports that there were over 18,000 of the short big-headed Greys at the Dulce facility. He also saw tall Reptilian humanoids at the base.

"I frequently encountered humans in cages, usually dazed or drugged, but sometimes they cried and begged for help. We were told that they were hopelessly insane, and were involved in high risk drug tests to cure insanity. We were told never to speak to them at all. At the beginning, we believed that story. Finally, in 1978, a small group of workers discovered the truth."

At lower levels in the base, row after row of humans and human remains were in cold storage. Also in the same areas (on Level 7) were embryos of humanoids in various stages of development. He also saw lots of human children remains in storage vats.

In the genetic lab areas, there were experiments that had been done on fish, seals, birds and mice that bore little resemblance to the original creature. There were multi-legged and multi-armed humans. There were lizard-humans in cages and humnaoid bat-like creatures.

By late 1979, he could not longer cope with the awesome reality he was confronted with. After much inner conflict, he decided to leave the facility and take various items with him for proof of what was going on there. Using a small camera, over 30 photographs were taken of areas within the multi-level complex. He removed a security video tape, which showed various security camera views of the hallways, labs, aliens and government personnel. He also retrieved various documents. Then, by shutting off the alarm and camera system in one of the 100 exits to the surface, he left the facility. The original materials were duplicated into 5 sets, which he entrusted with a few close friends.

Thomas was ready to go into hiding, but when he went to pick up his wife and young son, he saw a government van waiting in front of his home. The government agents wanted what he had taken in trade for the return of his family. It became quickly apparent to Tom that the government had no intention of returning his family to him, and that his wife and son were being used in experiments and were not going to be released unharmed. This was ten years ago.

THE DULCE PAPERS

The Dulce papers were comprised of black and white photos, a video tape with no dialogue and a set of papers that included technical information of the alleged jointly occupied (U.S.-Alien) facility 1 kilometer beneath a location SOUTH OF Dulce, New Mexico. Several persons were given the above package to hold for safekeeping. Most of those given the package were shown what the package contained but were not technically oriented and knew very little about what they were looking at. The following was written by one of these persons about what the papers contained. This person described the scenes that the video tape showed and made the attached pencil drawings of some of the photos. What you see is what you get; I can't decipher what is written or drawn anymore than you can. I pass these papers on only in the interest of getting to the truth. From other information I have I believe the information contained herein is true. I believe the facility exists and is currently operational. I also believe that there are 4 additional facilities of the same type, one located a few miles to the southeast of Groom Lake, Nevada.

Dulce papers: Lots of papers-documents that discuss copper and molybdenum, also papers about magnesium and potassium, but mostly about copper. Lots of 'medical terms' that I don't understand. A sheet of paper with charts and strange diagrams. Papers that discuss ultra violet light and gamma rays. Papers that discuss color and black and white and how to avoid detection through use of certain colors. In addition to these papers there are about 25 pictures, black and white, plus one video tape with no dialogue, 'all taken inside of the Dulce facility. These papers tell what the aliens are after and how the blood (taken from the cows) is used. Aliens seem to absorb atoms to 'eat'. Aliens put hands in blood, sort of like a sponge, for nourishment. It's not just food they want, the DNA in cattle and humans is being altered. The 'Type One' creature is a lab animal. "They" know how to change the atoms to create a temporary "almost human being". It is made with animal tissue and depends on a computer to simulate memory, a memory the computer has withdrawn from another human being. The 'almost human being' is slightly slow and clumsy. Real humans are used for training, to experiment and to breed with these "almost humans". Some humans are kidnapped and used completely (even atoms). Some are kept in large tubes, and are kept alive in an amber liquid. Some humans are brainwashed and used to distort the truth. Certain male humans have a high sperm count and are kept alive. Their sperm is used to alter the DNA and create a non-gender being called "Type Two". That sperm is grown some way and altered again, put in large wombs, many destroyed, certain are altered again and then put in separate wombs. They resemble 'ugly humans' when growing but look normal when fully grown which takes only a few months from fetus size. They have a short life span, less than a year. Some female humans are used for breeding. Countless women have had a sudden miscarriage after about 3 months pregnancy. Some never knew they were pregnant. Others remember contact some way. The fetus is used to mix the DNA in types one and two. The atomic makeup in that fetus is half human, half "almost human" and would not survive in the mothers womb. It is taken at 3 months and grown elsewhere.



2 CAMERAS EACH DOOR

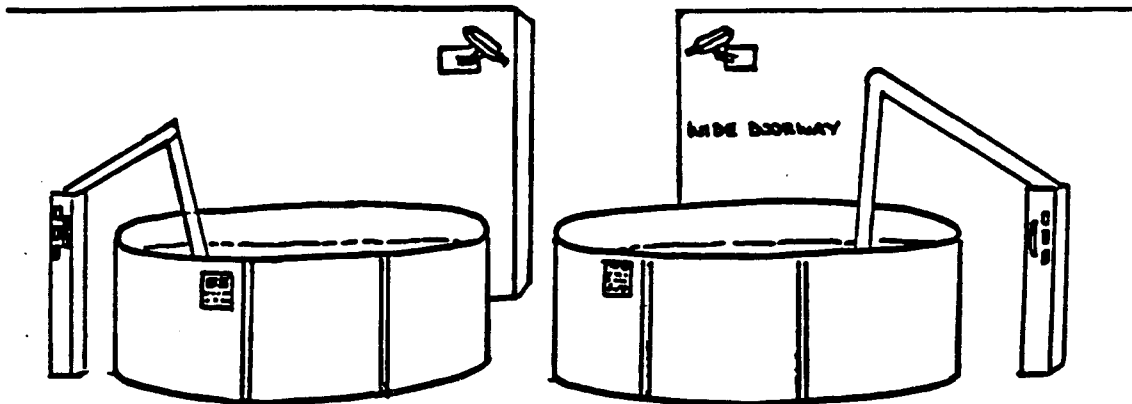

SCORES OF TANKS
OR MORE

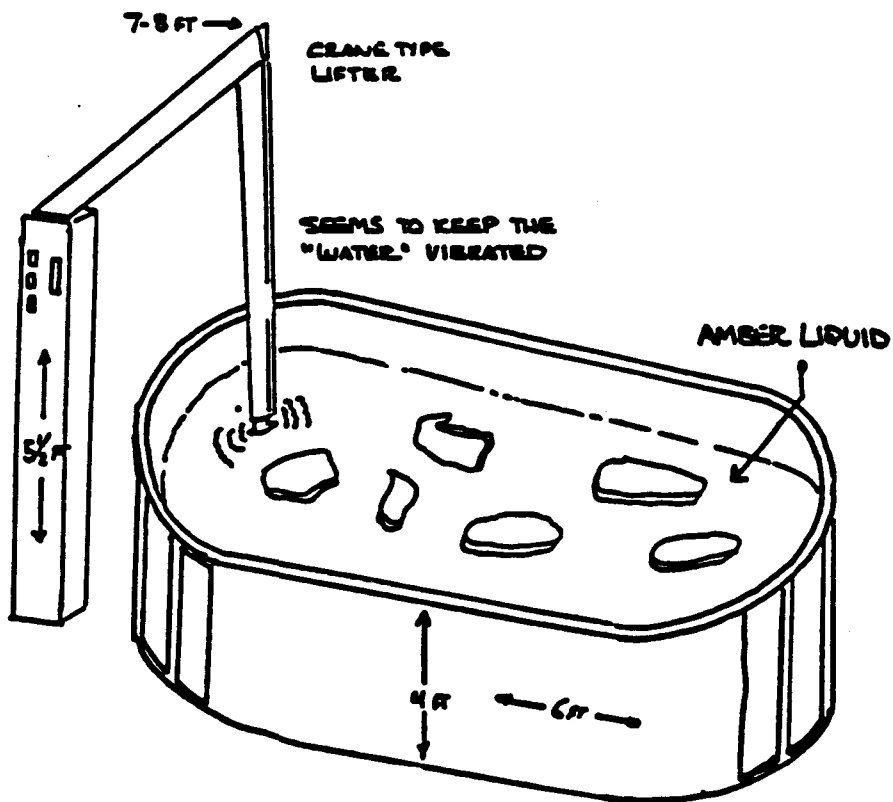

LOOKS LIKE LARGE PIECES
OF PALE MEAT IN CLOUDY
"WATER" SUBMERGED, NOT
FLOATING

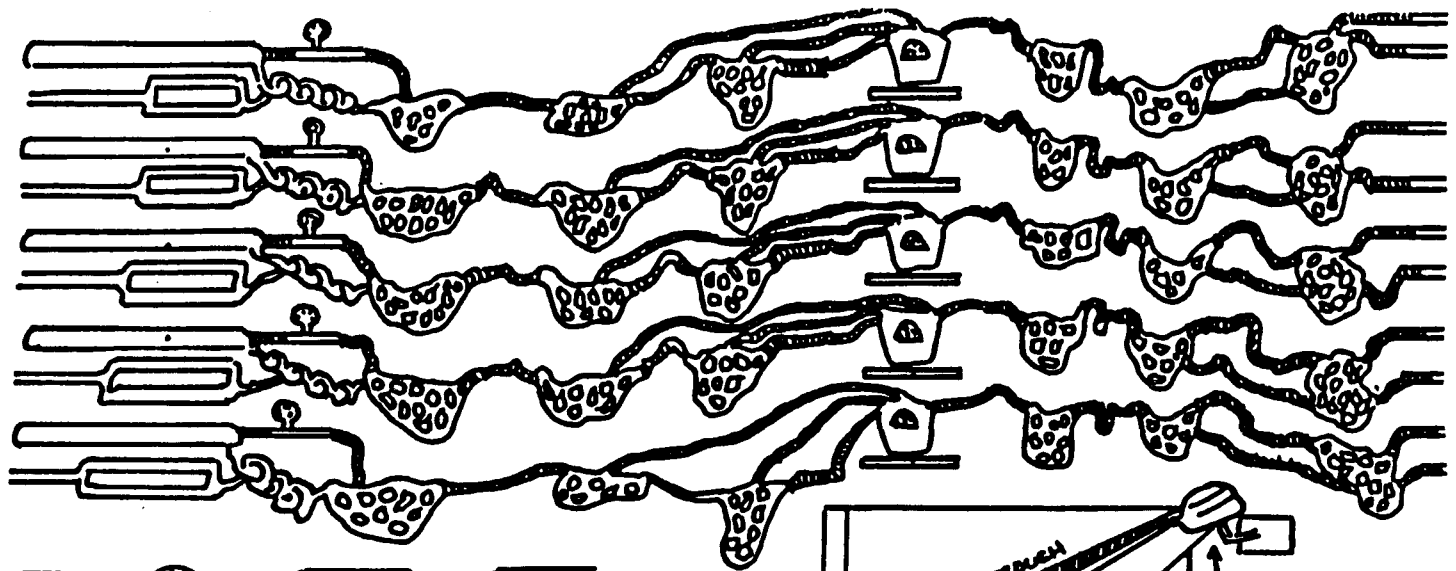

STRANGE
CLOCKER
GUAGE

TV
SCREEN

TV
SCREEN

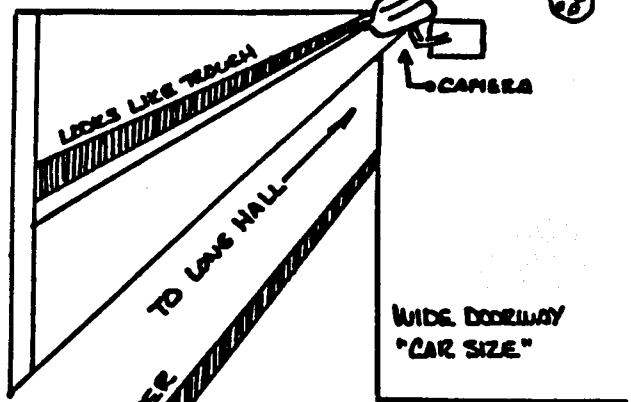
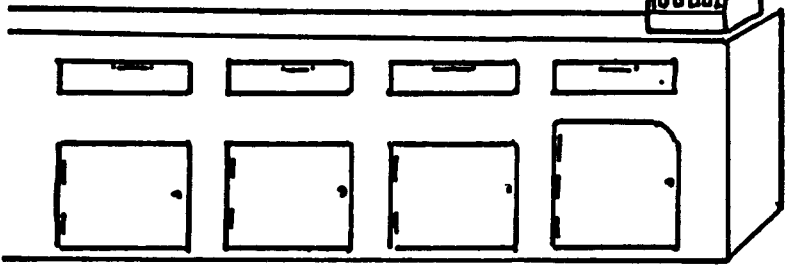

- ① MANY 'SACS' CONTAINING? ALIVE? LOOKS LIKE ANIMAL "BLADDERS" FLEXIBLE
- ② MANY OVERHEAD PIPES ALL SHAPES & SIZES. SOME PLASTIC.

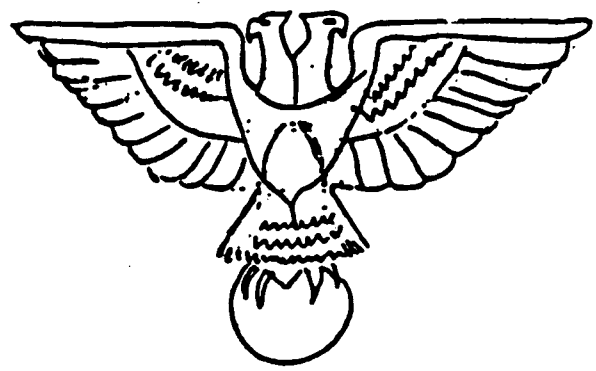

LYRAN EMPIRE

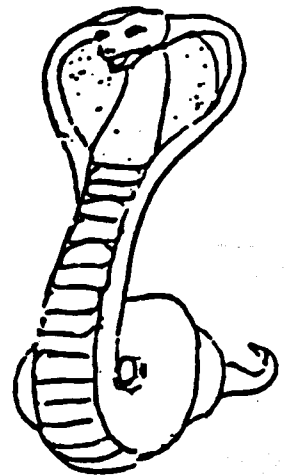

SETA RETICULANS

LOMS SUBMERGED IN SORT OF YELLOW LIQUID. LOOKS THICKER THAN WATER

HOOKS INTO MACHINES

CREATURES FLOAT IN AMBER COLORED WATER

LOMS IS GRAYISH WITH GLOBS OF YELLOW - WHITE IN GROOVES

DOZENS OF CREATURES IN EACH LOMB
CAN'T COUNT TANKS, MAYBE SCORES OR HUNDREDS

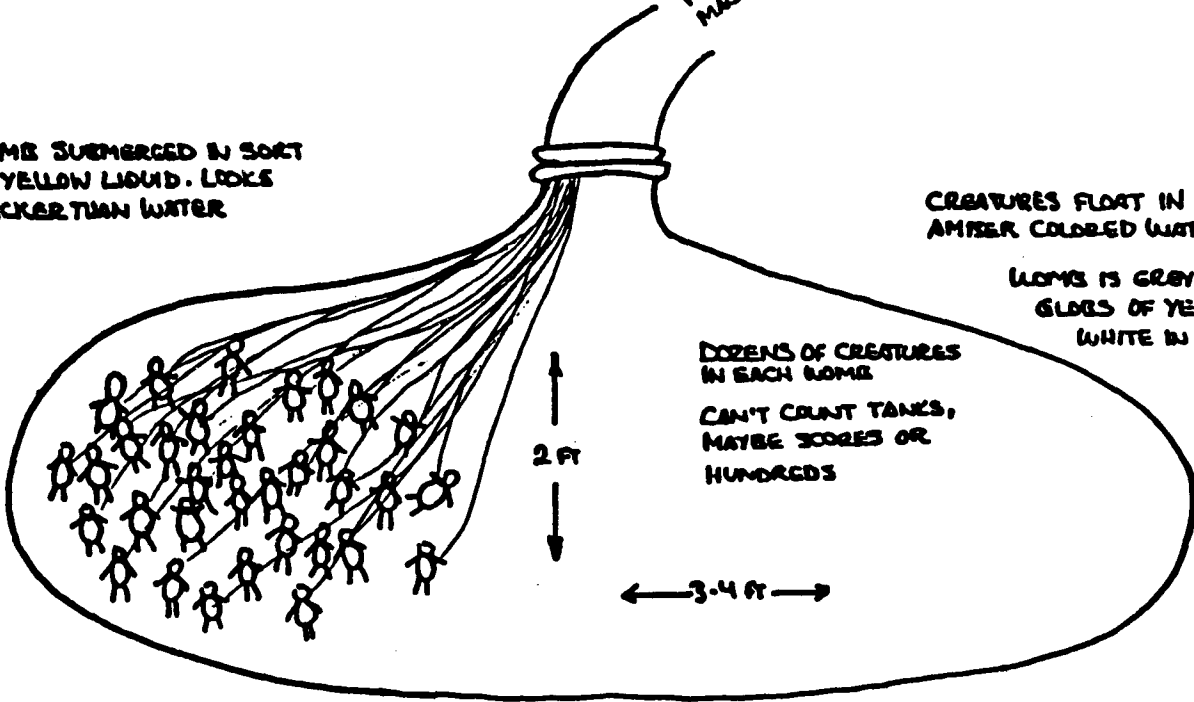

HAND JUST TO SHOW SIZE OF "BABY CREATURE"



3 FINGERS - 2 TOES
NOT HUMAN
COLOR WRONG, LOOKS BLUE-GREY
THIN SKIN
ABOUT 6 INCHES HIGH

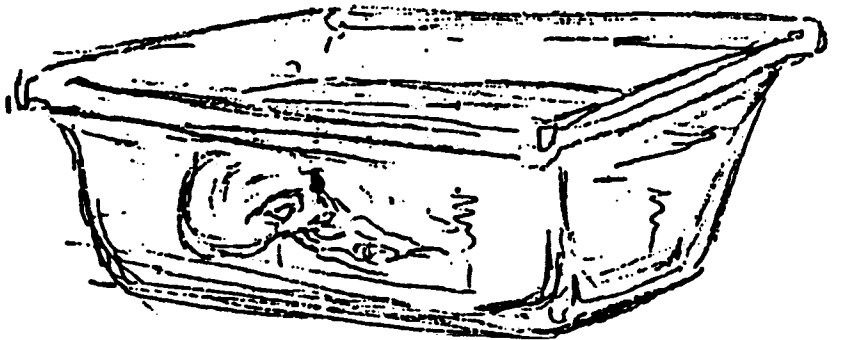
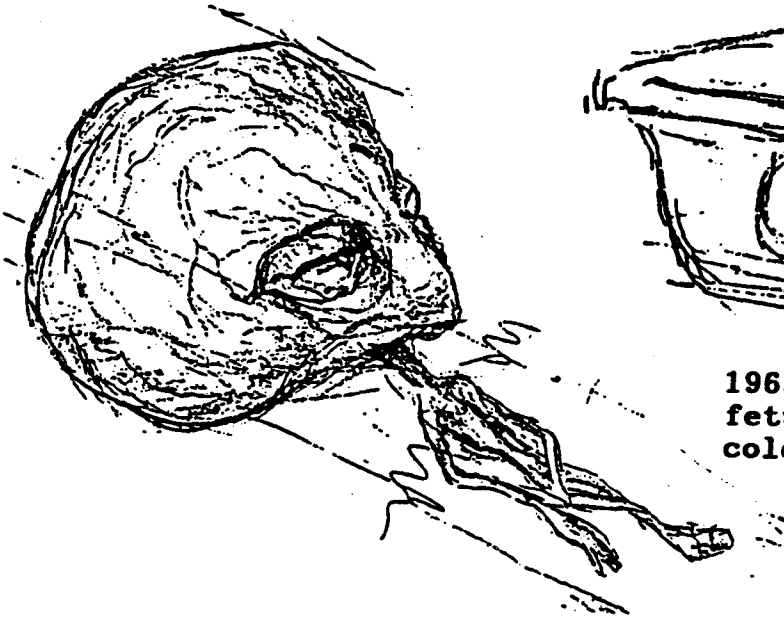

Seen as early as September 1963 in underground facilities. The fetus is a pearlized grey-white color and the veins stand out.



ROOM LIGHT: PINK-PURPLE
BRIGHT IN SOME AREAS

HUNDREDS OF THESE IN
VARIOUS STAGES OF GROWTH.

WISPY HAIR, "ALMOST NOSE"
MOUTH LOOKS "SEALED"

WOMB LOOKS GREY
VEINS (?) LOOK DARK GREY
CREATURE WHITE-PALE
EYES - DARK LIDS (?)
CAN'T FIND GENDER
2 TOES - 3 FINGERS

LIQUID - AMBER COLOR
NOT COMPLETELY CLEAR

LOOKS LIKE GLASS TUBE,
BUT ABOUT 5 FT TALL

GENETIC CAPABILITIES MADE PUBLIC: 1965

NOTE: MOST DEVELOPMENTS OCCUR YEARS BEFORE PUBLIC EXPOSURE.

SEPTEMBER 10 • 1965 • 35¢

BEGINNING A NEW SERIES ON THE
*Profound and Astonishing
Biological Revolution*

Control of Life

Image of baby's head in womb is projected
onto screen by ultrasonic waves
transmitted through water-filled bag



*Audacious experiments
promise decades of added
life, superbabies with
improved minds and bodies,
and even a kind
of immortality*

As is seen here, it is not long after Kennedys death that technology in this area really took off. With Kennedy gone, there was no check left in the system to prevent permanent intergration and use of alien based technology. The Dulce labs are underground genetic facilities where hybrid breeding is done and human experimentation is rampant. The RAND CORPORATION is allegedly involved in the hiring of personnel. Major political figures have been implecated as having knowledge of Dulce and the alien situation.

A placenta simulator
and infant opossums may
one day lead to

Superbabies

COMPARE THE PICTURE ON THE LEFT BELOW WITH DRAWINGS OF DULCE

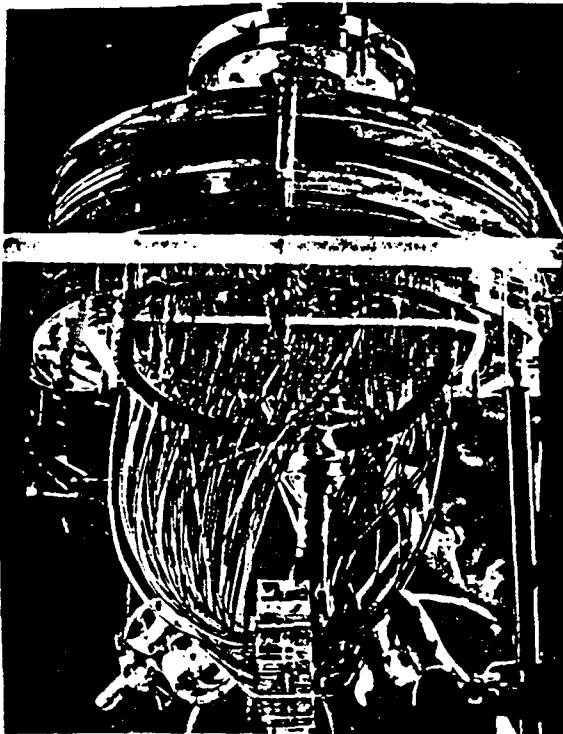

At right, drugs are added to milk flowing to infant opossum in tank that simulates a mother opossum's pouch. The pictures below show how Dr. Krentz's machine simulates placental exchange of substances between the bloods of mother and fetus. Purpleh

mess in machine's center is a living human placenta. In top picture, technicians connect tubes representing fetal blood vessels to the umbilical cord. Bottom picture shows blood flowing to and from placenta in tubes that simulate mother's circulatory system.



D U L C E B A S E

Perhaps the most widely referenced area that allegedly has a base is 2.5 miles northwest of the town of Dulce, New Mexico. The area is normally referred to by researchers and abductees alike as DULCE. The base lies under a kilometer of rock south of Dulce¹. Over the past 10 years, a lot of data has come in about this facility. That data indicates that there are many other bases with similar function, and that many of the early underground facilities belonging to the Atomic Energy Commission in the 1950's were eventually turned over to projects relating to alien technology. Most apparently were added on to by the forces that occupied them.

The area around Dulce has had a high number of reported animal mutilations, although the number of mutilations slowed down in the mid-1980s when Lawrence Livermore labs accelerated production of artificial blood. Increasing tension between government forces and aliens over the last several years might have caused a cessation of artificial blood and other supplies, since both animal and human mutilations (as well as abductions) increased markedly starting in 1987. At present, the frequency of all these events has reached a level reminiscent of 14 years ago when there were tense times between alien and government personnel.

Residents of the area report that a certain section of road around Dulce Lake has been the site of several accidents. It is said that drivers report that they see a straight stretch of road where the road apparently curves. Elders of the local tribe report that when they walk by this area they have a similar visual problem. Some of them have even fallen in the lake because of this. These same Elders refrain from discussing the animal mutilations. One interesting fact is that the Jicarilla Indian creation myth says that they emerged from underground, and that human beings were created by beings from under the earth.

Rancher Ed Gomez has a ranch 13 miles west of Dulce. From 1975 until 1983 the Gomez ranch was the scene of most of the cattle mutes in the northern New Mexico and southern Colorado area. The Gomez homestead, which is over 110 years old, has lost over \$100,000 in cattle over an eight year period. One of the cases occurred 200 yards behind his home. This rancher also related to researchers that combat ready troops have been spotted in areas that only the Indians have permission to go.

In 1978 there was an agreement between the Ute Indians in Colorado and the US Government that consisted of the Ute Indian receiving all the territory now occupied along the border between New Mexico and

Note 1: The installation is NOT under Archuleta Mesa, but south of the town of Dulce. The Archeleta Mesa scenario has been proven to be incorrect, and has been leading researchers astray for several years.

LEVEL 5

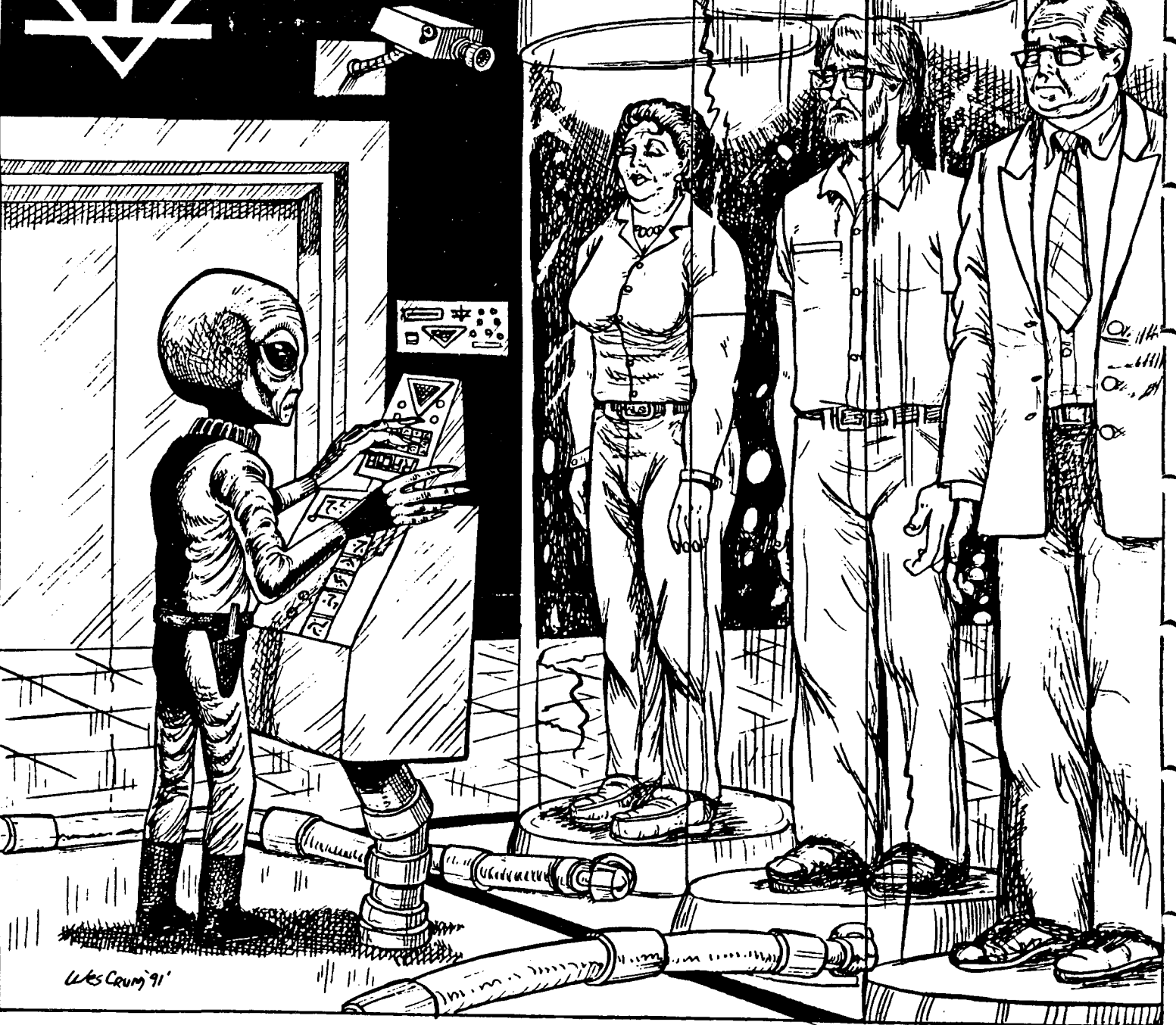



This depiction of a grey sub-species was drawn under hynosis by a man who claims he was abducted in 1980 north of Denver, Colorado.

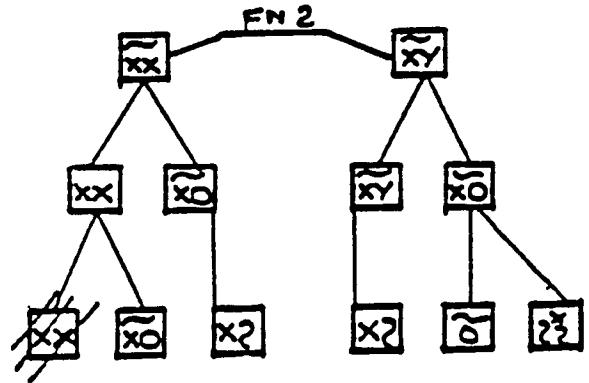

Genetic Diagram From Facility Near Dulce

PEOPLE SHOULD NOT BE TREATED LIKE CATTLE,

AND PERHAPS EVEN CATTLE SHOULD NOT BE TREATED LIKE CATTLE.



* SECURITY UNIFORM

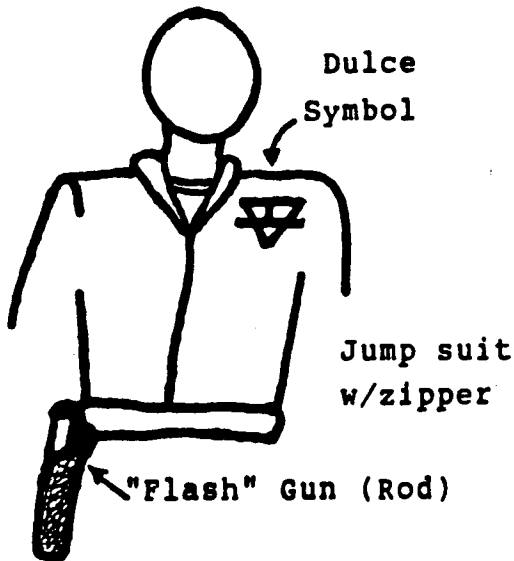

* CODED ELEVATOR CONTROLS

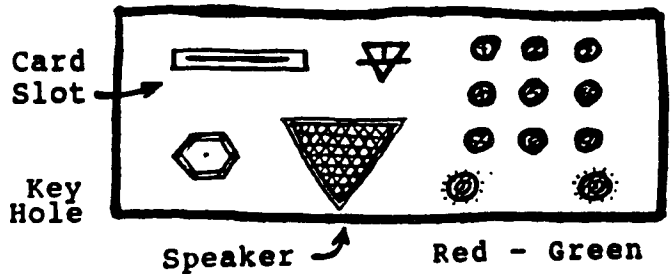

* ELEVATOR & DOOR "ID" CARD

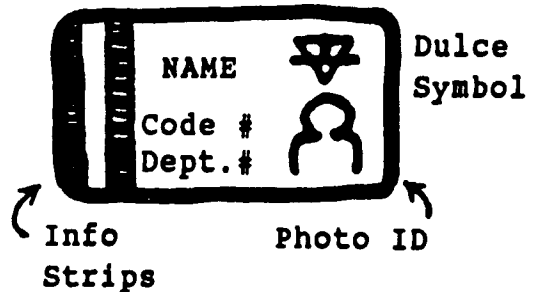

MORE DETAILS OF THE BASE NEAR DULCE FROM A FORMER PARTICIPANT

Colorado with the explicit agreement that they would strictly enforce a "no trespassing" policy. It is not possible to cross the Ute reservation without special permission from Tribal headquarters. If caught without permission you are liable for a fine and/or jail and expulsion.

It has been noted by visitors that Dulce townspeople openly discuss the abduction and implantation.

A recent field investigation of the area adjacent to the Mesa proved to be difficult. Researchers were confronted by several small hovering spheres that had some sort of electronic emission that made them all violently ill.

Activity in the area of Dulce, New Mexico began almost at the same time as the Roswell crash - 1947. Studies of the area have confirmed that summer troop movements occurred every year after 1947 for quite some time. The construction of a road into the area was done, and trucks went in and out of the town. Later on, the road was mysteriously blocked by the military and destroyed. Some residents of the area remember signs on the trucks which referred to a company which was later proven to be a cover - no company by that name has ever existed. The initial base was built under the cover of a lumbering project - unfortunately, they never hauled logs, but just large equipment.

Since the initial activity seemed to occur in the same year as several disk crashes, one might wonder why the military would be carrying on a large construction program of this nature, especially since it occurred some 12 years before the famous RAND CORPORATION conference on Deep Underground Construction, which occurred in 1959.

They might have discovered information about the base from analysis of the crashed disks or the reptilian-based entities they found on board. It is possible that this facility was functional earlier than 1947. We do know that the base was made in stages using alien technology. Most everything in the base is controlled magnetically. Even the illumination is magnetically induced.

What we do know is that the upper levels were built after the lower levels - or onto the lower levels. In other words, a US base was built on top of a pre-existing alien base. This is not the only location where this phenomena has taken place. There are indications that there are situations like this up at the Nevada Test Site and elsewhere. Deep sections of the complex are connected to natural cavern systems.

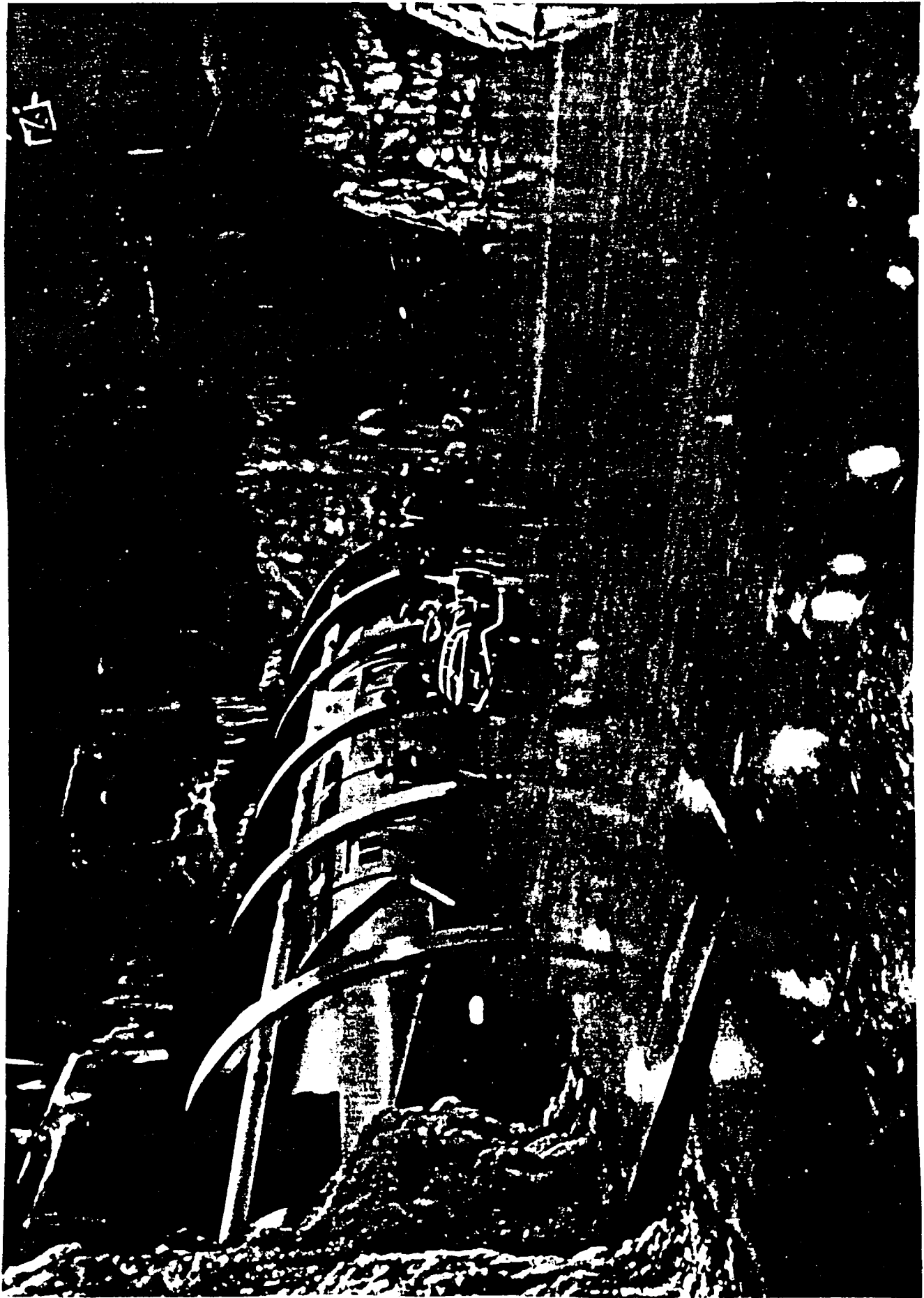

197-A

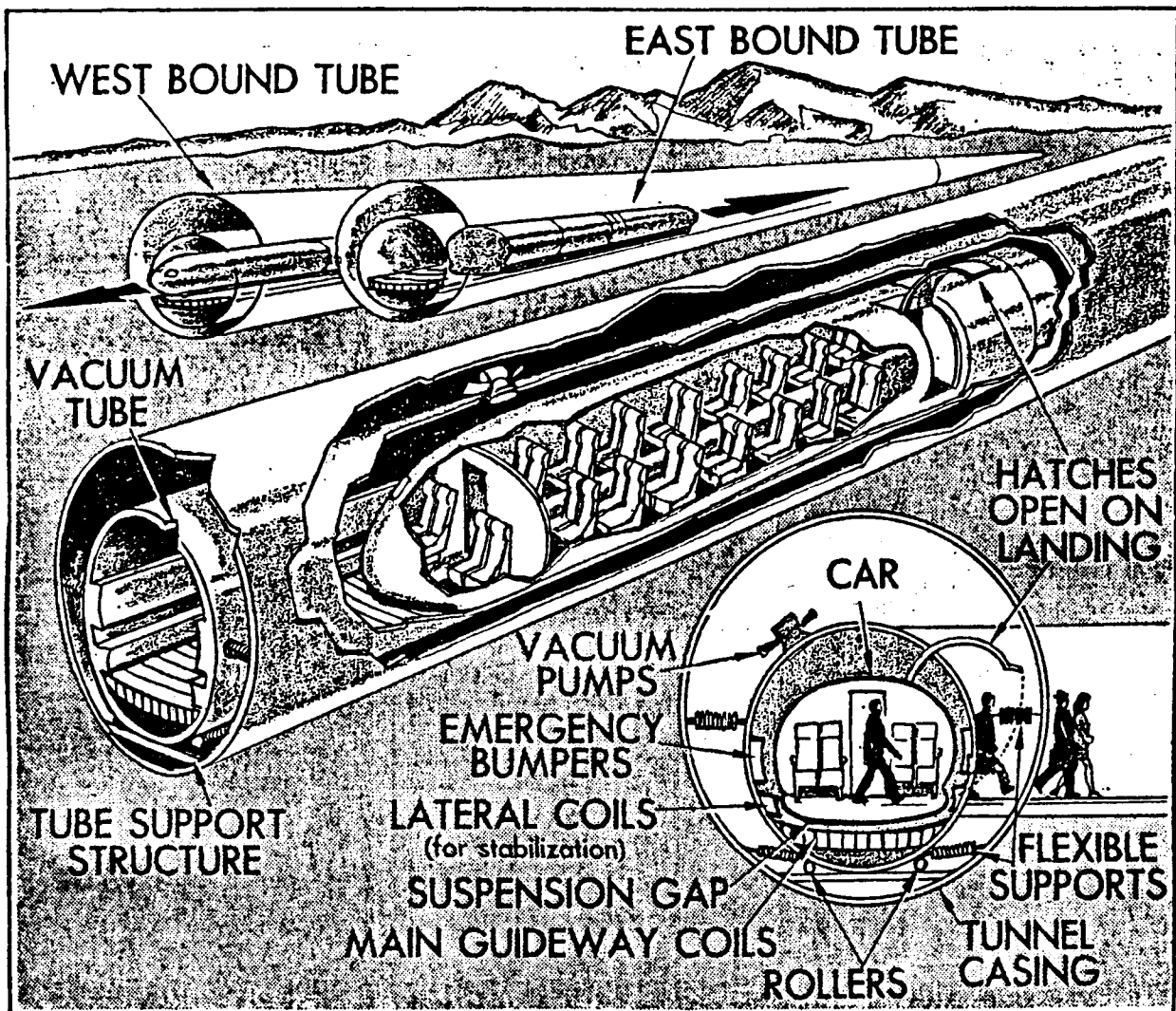

L.A. TO N.Y. IN HALF AN HOUR !

(Los Angeles Times)

June 11, 1972

The Rand Corp. has devised a rapid transit system to get you from Los Angeles to New York in half an hour for a \$50 fare.

Existing technology makes such a system feasible, and so does a cost analysis. The idea of high-speed train travel using electromagnetic suspension was first put forward in 1905 and actually patented in 1912.

The essence of the idea is to dig a tunnel more or less along the present routes of U.S. Highways 66 and 30. The Tunnel would contain several large tubes for the east-west travel of trains that float on magnetic fields, moving at top speeds of 10,000 m.p.h. This train or "Tube Shuttle" would be big enough to carry both passengers and freight, including large containers and automobiles.

On the main line there would be intermediate stops at Amarillo and Chicago. Feeder lines would meet the main line at both locations.

There also would be subsidiary lines coming from such cities as San Francisco, Boston and Washington.

The tunnels, are not as expensive to dig as people think. The most expensive thing about surface routes is in acquiring rights of way and removing buildings, etc. The Tunnel would not incur this expense. The tunnel could also carry, in the tubes, many of the utilities now strung across the countryside on high wires.

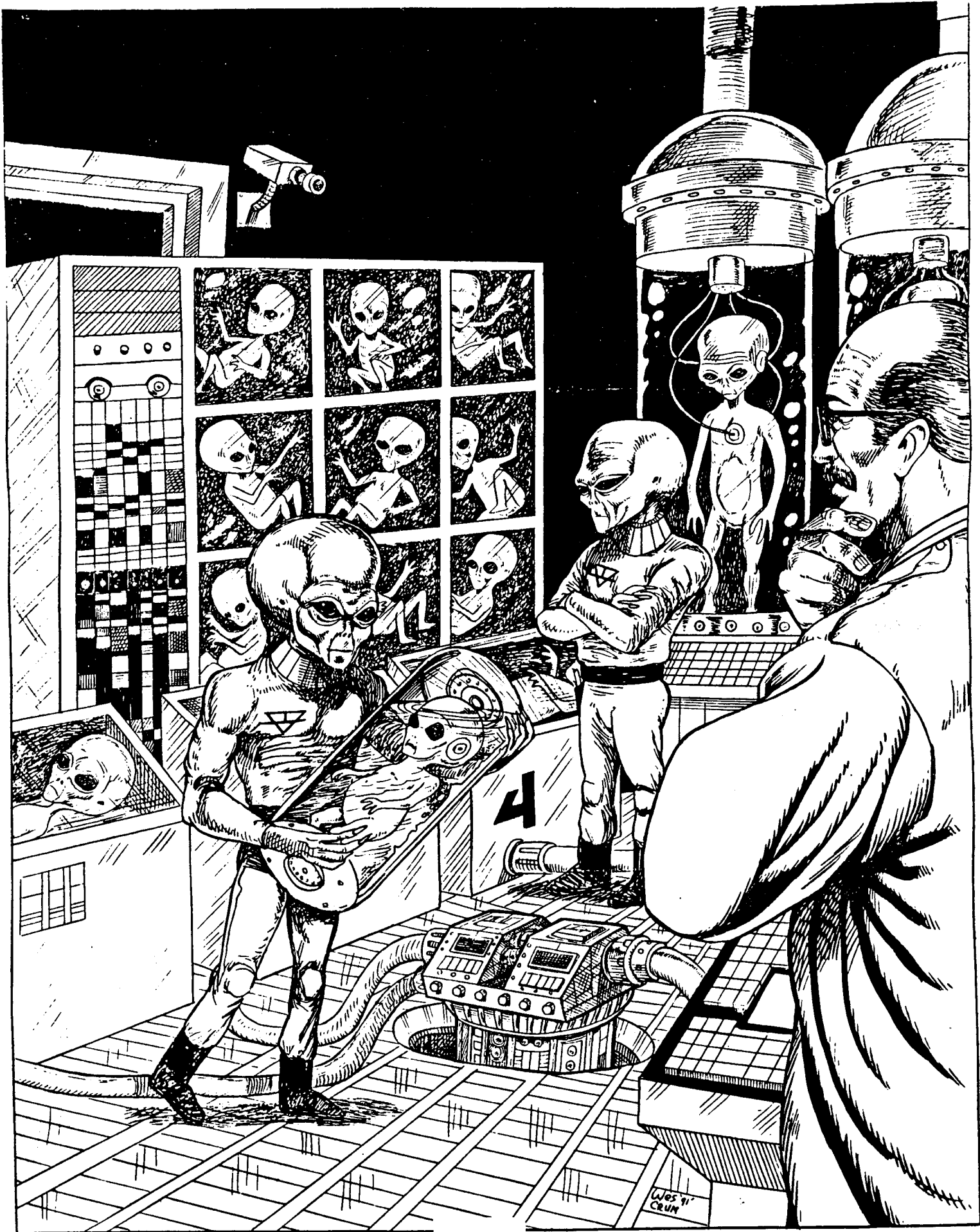

Typical Entity being Bred



This type of entity is the one that abductees and contactees have seen in underground breeding facilities since 1963. They are bred by the thousands . Dulce Facility is the most well known place that this activity occurs, although there are at least 26 bases within the US that have similar facilities.

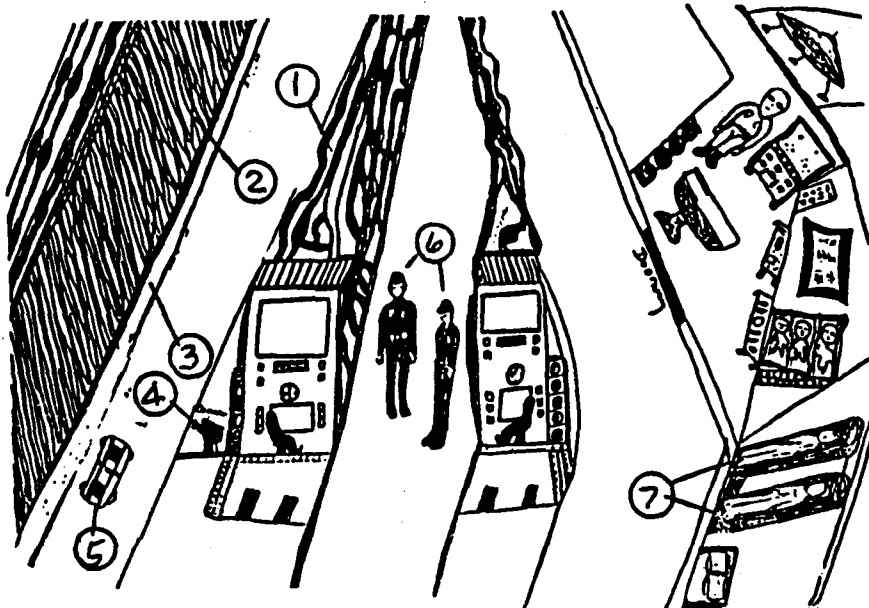
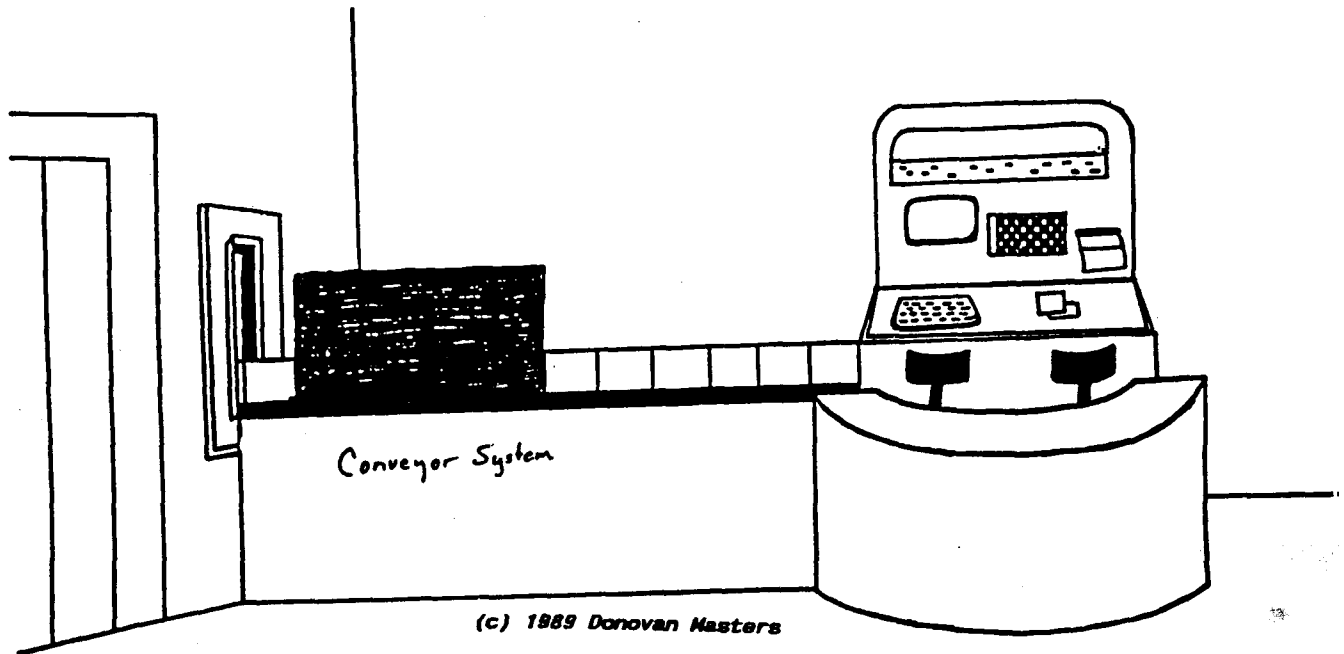

(c)1987,88,89,90 CRUX Publications.

- (1) Connecting pipes overhead
- (2) Black grooves running vertically
- (3) Moving conveyor system
- (4) Camera
- (5) Machinery on Wheels
- (6) Guards with black uniforms and red insignia. Same at Dulce and Groom Lake.
- (7) Hybrid-looking creatures in clear casings



We know that the base consists of a many-leveled cylinder with tunnels radiating out in several directions. There are at least 7 levels. We know (through personnel who have worked there) that the first two or three levels are primarily US government personnel. We know that senators and astronauts have been brought to the facility and have been shown the first several levels. The facility appears to be a state of the art cryogenetics facility and laboratory.

After the 2nd level, everyone who enters any level is weighed in the nude, then given a uniform. Visitors are given an off-white uniform. In front of the doors to all sensitive areas are scales, which compare the individuals weight to what it was when they entered the facility. The persons ID card must match the registered weight and code for the area for the person to be able to enter or leave.

Any discrepancy in weight over three pounds will summon the security people. No one is allowed to carry anything into or out of the areas. Alien symbols are visible all over the facility.

Research at the 4th level includes research on the human aura, research on telepathy, dreams and hypnosis - all geared toward control and manipulation of other beings. Technology is at a state where they can manipulate the bioplasmic body of human beings and program them through introduction of programmed reactions and images which will induce the desired result - completely control them. They can remove an individuals consciousness and replace it with another consciousness - either synthetic or alien.

We know that level 5 has alien quarters there; level 6 is a genetics laboratory using alien technology. It has been referred to as the "nightmare hall" by employees. Many-limbed humans and other creations reminiscent of stories of Atlantean experimentation reside there. It is an attempt to breed slave beings suited for specific tasks. It sounds like an Edgar Rice Burroughs story, yet it exists. One of the employees who worked there was the source for the photographs and materials that were the basis for the drawings and notes referred to as the "Dulce Papers".

Level 7 is where human children and adults are stored as a source of biological materials. Remember the long ships in the series "V" where all the humans were stored? It's similar to that, but it is more of a production laboratory situation. Humans have been seen stored in clear cylindrical containers over 6 feet in height, suspended in a yellow or amber fluid - alive and conscious but unable to scream or say a word - a common observation in this installation as well as some of the other 26 installations in the midwestern US.

In the same area at Level 7 are the production areas for humanoids, the vats containing animal and humanoid body parts. There are pictures and video tape of this facility - there is no doubt that it exists. It is like something out of the Burroughs Martian series - do you suppose Burroughs was a member of a covert group even in his day and knew this activity was going on?

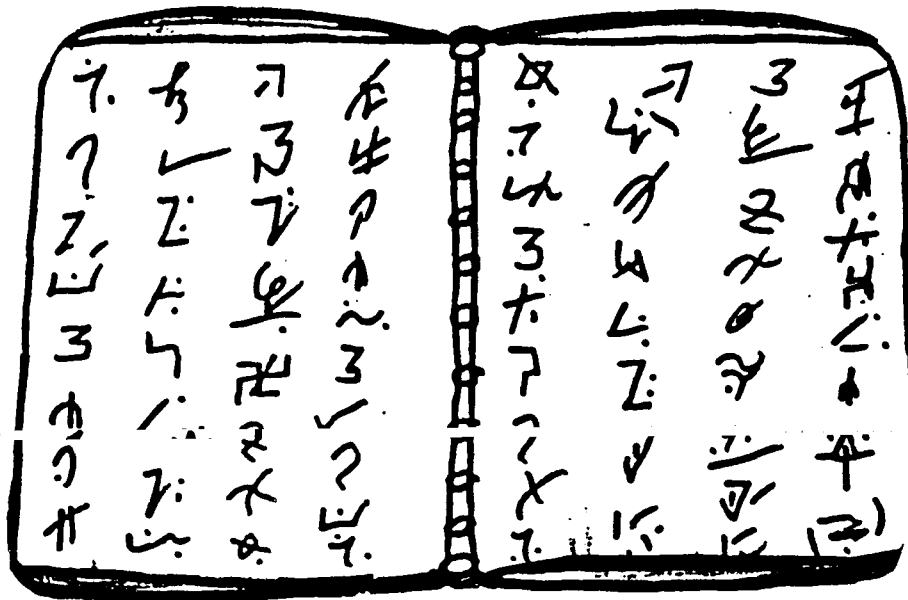

"This book of symbols was seen in the underground area and on board the craft. They urged me to study its contents. They said I knew what each symbol meant, and stated that a computerized beam was relaying the meanings to me."

(c)1987,88,89,90 CRUX Publications.

Underground coal mines

Level One- Red



(c)1987,88,89,90 CRUX Publications.

Biogenetic research gained at Los Alamos, New Mexico was funded under the cloak of secrecy. It was combined with alien technology in the genetic sciences to produce expendable biological entities for use as the makers see fit. Cloning of humanoids is part of the natural progress of scientific development along "service to self" lines; that it is going on there is absolutely no doubt. There is also no doubt that political figures in governments have been cloned and reproduced.

It sounds like the plot from a grade B movie, doesn't it? Well, what is more comfortable for humans to handle in the guise of science fiction as actually based on fact; the main reason that this problem exists to the extent it does is that it is all literally underground and covert.

Although the base actually has more than 100 exit points, including large air intake ducts near Lindrith, these exits and other areas inside the base are covered by cameras. Everything and everyone is watched and monitored.

In 1978, a small group of workers at Dulce discovered the true nature behind the facility and a resistance unit formed; a resistance unit is a touchy thing in a base that was estimated in 1978 to have a population which included over 18,000 alien beings. By late 1979, the situation led to a confrontation over the flash-tube weapons that US government and alien security forces carried. A lot of humans were killed. Members of the NRO's Delta Security team were among the casualties.

On October 23rd and 24th, 1988, a research party consisting of Dr. John F. Gille, who has a PhD in Mathematics and Physics from the University of Paris; Gabe Valdez, head of the State Police in Dulce; Edmond Gomez, his brother Manuel, and officer Valdez' two sons Jeff and Matt, visited the Dulce area for an expedition. At 7:51 pm they noticed a very bright boomerang shaped object radiating white, blue and green light. As it approached them, it slowed (obviously under intelligent control), seemed to reverse direction, and stopped. It then sped out of sight.

On October 24th, the party climbed Mt. Archuleta in order to conduct a search for debris from an alleged crash of an "experimental aircraft" flown by an Air Force General in 1983. This crash was reported in the newspapers for two days as having been a small plane, then it was hushed up. The craft was rumored to be a captured disk flown by Americans. Paul Bennewitz reported at one time that the craft had clipped off a large tree in its descent, has hit another tree, regained altitude, skimmed over Archuleta peak, and hit a third tree in the valley north of the peak. It was then reported to have hit the ground and flipped over twice before coming to rest.

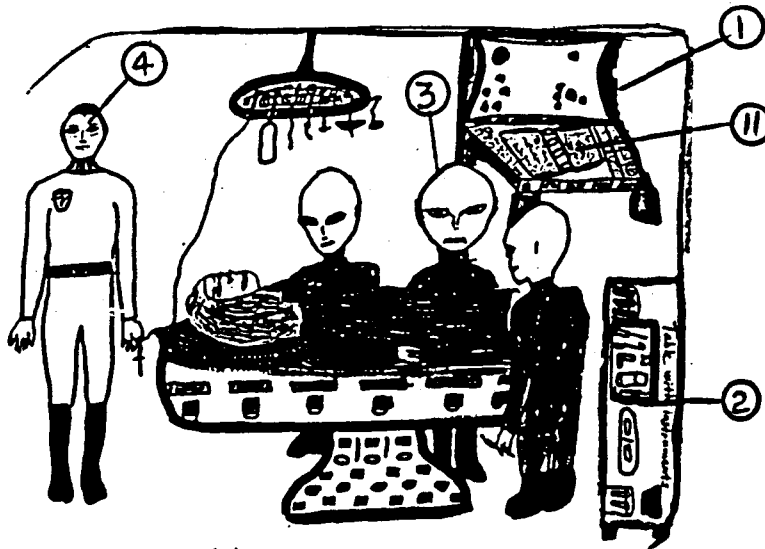

(c)1987,88,89,90 CRUX Publications.

- (1) Holographic Screen
- (2) Table with Instruments
- (3) White-Grey beings who helped the doctor
- (4) Maijan, the doctor. Light blue suit, one piece. Black boots, black belt.
- (5) Steel bars and catwalk
- (6) Sounds of liquid circulating
- (7) Guages
- (8) Flexible tubing that expanded with pressure.
- (9) Clear liquid inside tubing.
- (10) Cream-colored tank with seams
- (11) Book with symbols they made me review
- (12) Horrible chemical smell in the air that burns the nose.

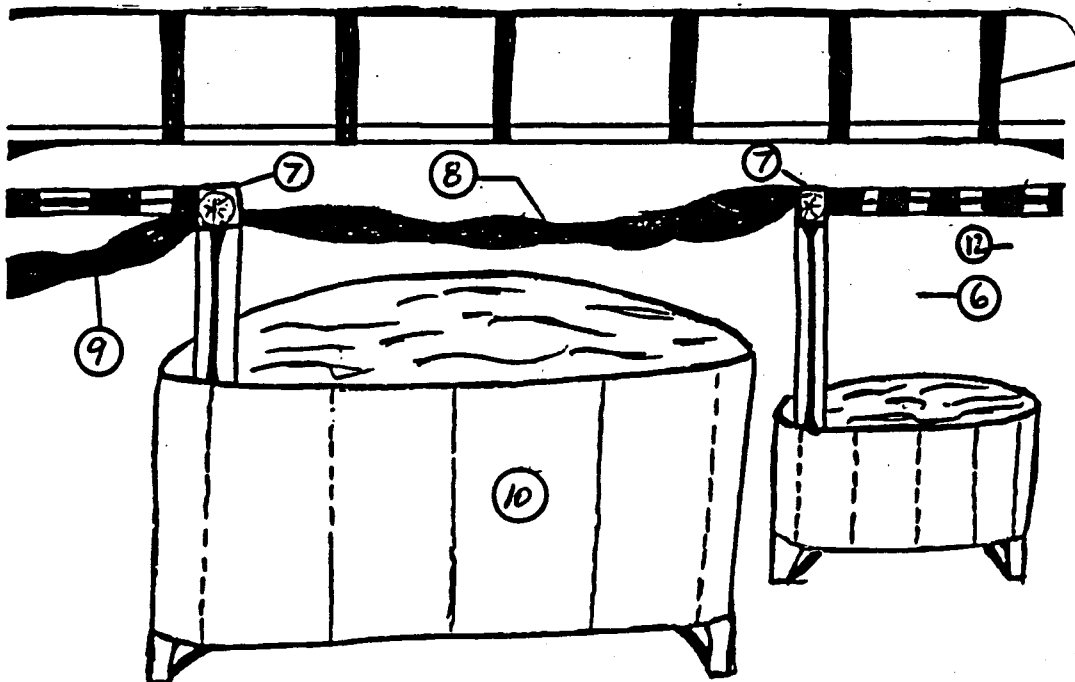

(c)1987,88,89,90 CRUX Publications.

ENTITIES SEEN BY ABDUCTEE CHRISTA TILTON
(c)1987,88,89,90 CRUX Publications.

EBE # 1

**Around 5 feet tall. Tan stretch body suit.
Thin lips. Seen in 1952**

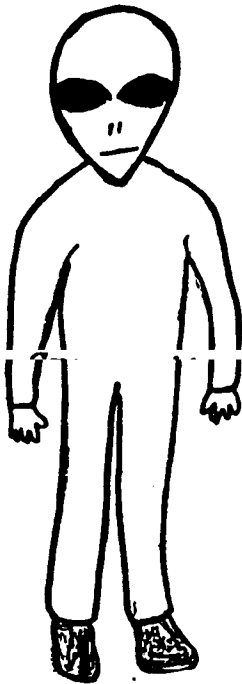
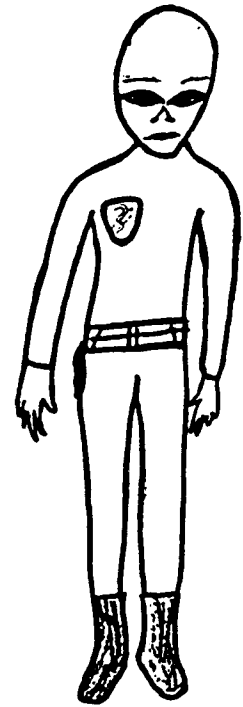

EBE #2

**Around 4 feet tall. Grey suit. Pointed
chin. Larger eyes and slit for mouth.
No emotions. Walked like a robot.
Seen in underground facility**

EBE #3

**Around 5'6" tall. Thin, human looking.
Greyish tan skin. Thin blond hair to
shoulders. Seemed caring but stearn.
Seen on every abduction experience.**



The research party found all the trees as reported by Bennewitz. Samples were taken. While searching they found a US Government ball point pen, which was totally out of place in this remote canyon. The alleged crash area showed a large semi-circular area with new vegetation. The area above the semicircle was also covered with new vegetation. Samples of the soil in the area were also taken.

When the experimental craft went down in 1983, it was reported that there were "hundreds of troops, armed to the teeth" in the area. When approached, the troops would "run and disappear", which is highly uncharacteristic of combat soldiers (unless they had a reason to hide from observers).

There are apparently 4 additional facilities of the same type as the Dulce facility. One is allegedly located a few miles to the south-east of Groom Lake, Nevada.

According to some researchers, Dulce is run by a "board" called "The Committee". At one point in time it was alleged that energy secretary John Harrington was the chairman of this board. It was also alleged that Senator Howard Baker was the CIA link to Dulce, that Jim Wright filled the treasurer position, and that there was some sort of power struggle going on in 1988 and 1989.

It has also been alleged that seven astronauts were given a tour of the Dulce base and that Senator Schmitt has full knowledge of the Dulce installation.

Known Activities At Dulce Base

The United States Government has maintained an interest in so-called "disposable biology" humanoids, to perform tasks that it considered too dangerous for humans. With the knowledge gained from work at Sandia and Los Alamos, along with knowledge gained by interacting with alien technology, the government has achieved the ability to produce humanoids for this purpose.

The abilities of the United States Government have been advanced enough (and this has been confirmed by witnesses) to instigate the same clandestine impregnation of human females in order to achieve 3-month hybrid fetuses, which are grown further in labs under alien technology. In other words, the Greys are not the only ones doing this to the population of the United States. The hybrids thus generated are products of DNA manipulation. Implants that functions as brain transceivers are also installed, and are controlled through RF transmission (regular radio frequencies). The network of hybrids was apparently put together by the Defense Advanced Research Projects Agency (DARPA) and include R.H.I.C. (Radio-Hypnotic Intracerebral Control) and E.D.O.M. (Electronic Dissolution of Memory) type controls, which were developed in the latter half of the CIA/NSA mind control programs of MKULTRA and MKDELTA.

ALIEN BREEDING FACILITIES

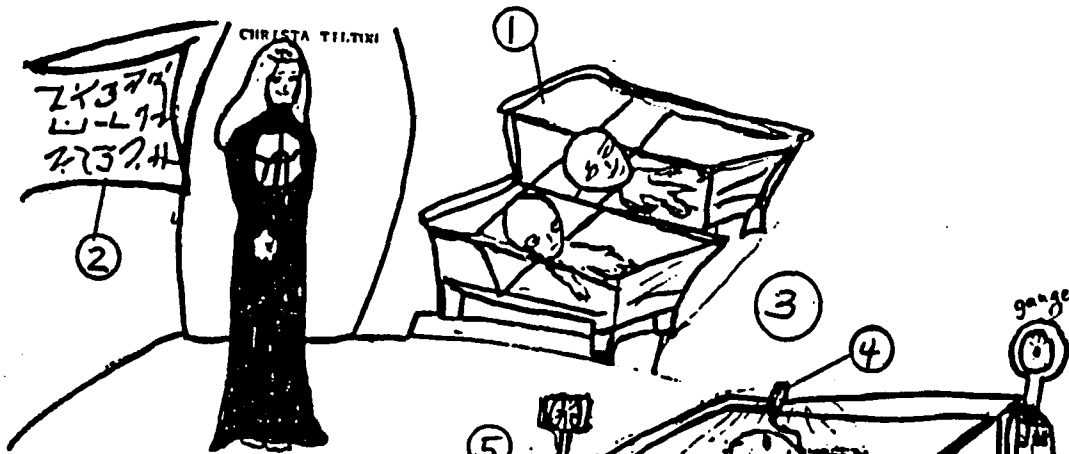

(c)1987,88,89,90 CRUX Publications.

- (1) One month old fetus
- (2) Holographic computerized screen with moving symbols
- (3) Genetic Acceleration with three to five month period of gestation
- (4) Line feeding tube
- (5) Computerized tanks with gauges, buttons and reading devices

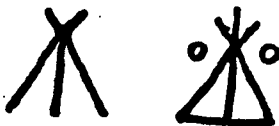

Sketched after regressions with Budd Hopkins in 1987. This is only part of a large room with many incubators. The woman with black hair urged me not to go close to the incubators. It had to do with a special lighting there. I was shown another child of mine who looked to be around 3-4 years old. I was told

there was a different donor for this child. They would not allow me to bond with this child. I was allowed to name her and told I would see her again. I felt no emotional bond to the child.

© Christa Tilton - 1987

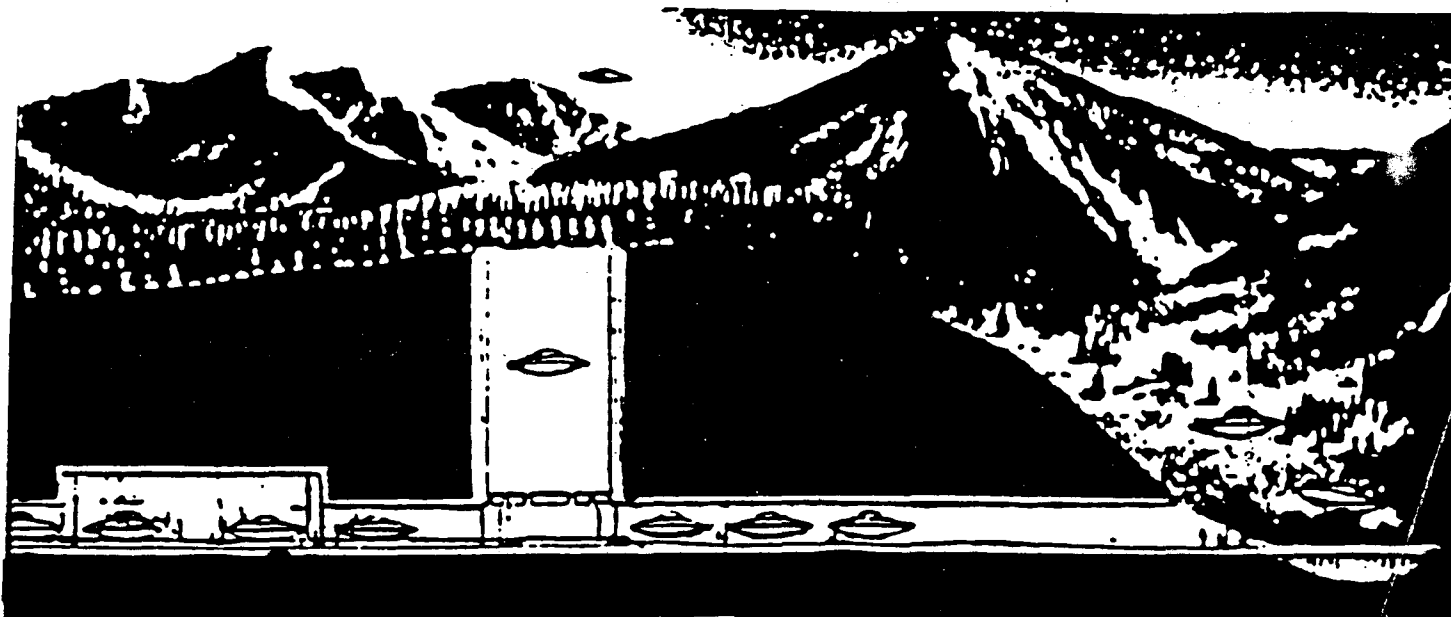

Development of Extremely Low Frequency (ELF) wave propagation equipment and other electromagnetic devices that can cause humans nervous system damage, nausea, fatigue, irritability, and death has been taking place - machinery that functions the same as the devices that Richard Shaver talked about when he referred to the DEROS and their "telaug" machines. Research into biodynamic relationships with-in organisms (essentially biological plasma) has produced the outstanding capability to radiate an organism and change its genetic structure - an ability that could be used for health applications if these people wished to use it for that. These people have harnessed the "dark side" of technology and have hidden the beneficial aspects from the public in order to perpetuate the current system of disease instead of health - it is conducive to trimming down the population as well as generation of funds needed for continuation of these covert practices.

A significant portion of the base is geared toward maintaining the survivability of the alien population. The main focus of these facilities appears to be acquisition and processing of biological materials in order to assure a supply of DNA and other biological materials for production of both aliens and synthetic lifeforms.

Synthetic lifeforms are created with animal based tissue, which can take on any form (genetically manipulated), including artificial neural matter. Alien technology permits the withdrawal of memory from a human being and the implantation of that memory in synthetic neural networks; other methods use molecular computers to simulate memory.

The humanoids created by these methods end up being slow and clumsy. They have relatively short life spans, typically about three years - usually shorter. Humanoid lifeforms are also bred with standard human beings, producing hybrid lifeforms - the desired result is to produce self-breeding hybrids to function on the lower end of another Master-Slave game for the alien species. Terrestrial humans are in the middle.

Terrestrial humans are also used for training purposes - to train synthetics - and to train themselves to perform duties imposed by their alien captors. Some humans are kidnaped and completely used - right down to the atomic particles in the matter that forms the body.

Terrestrial humans are also treated with various mind control techniques, such as the Orion method of hypnosis (hypnosis + drugs + repetition) and used to spread disinformation or distort information that will lead others astray.

The DNA acquired from animal and humans is altered and used to create lifeforms that grow to adult size in a matter of a few months, allowing for massive reproduction potential. Actual mixing of DNA types to create new lifeforms which are a hybrid between the human and the non-human are done inside the fetus that grows inside a

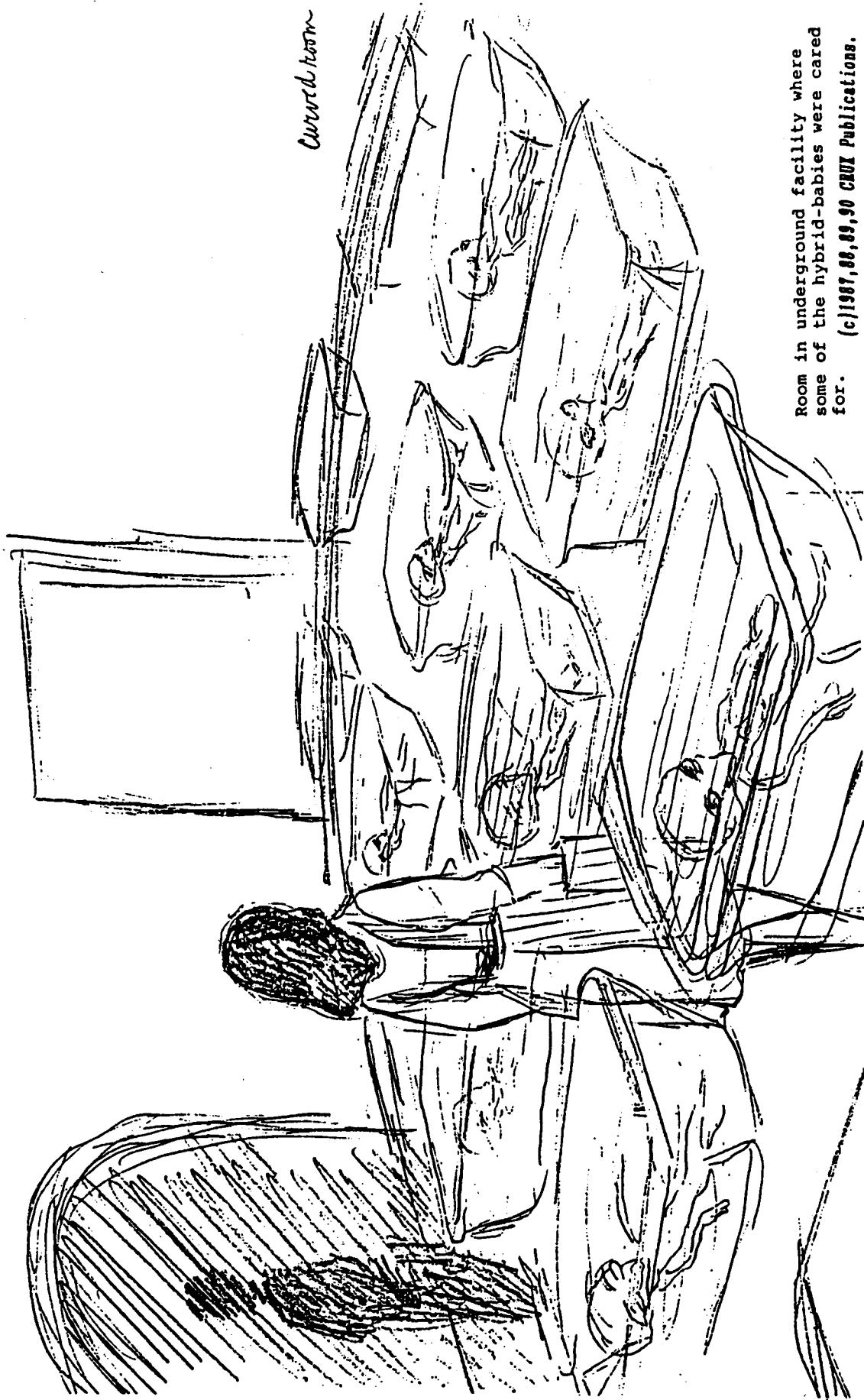

Coward room

Room in underground facility where some of the hybrid-babies were cared for. (c)1987,88,89,90 CRUX Publications.

UNDERGROUND HYBRID CARE FACILITY

manipulated human female, often for only about three months. This is the process which happens to a great many female abductees, often with total disregard for the individual's health. One sign that is an indicator for some human female abductees is that they might have three light periods followed by a heavy one - that kind of cycle. This, combined with other physical signs (such as bruising, injection sites, gouged areas of skin, etc) that appear without due cause is a sure sign that the person is being actively used in this way.

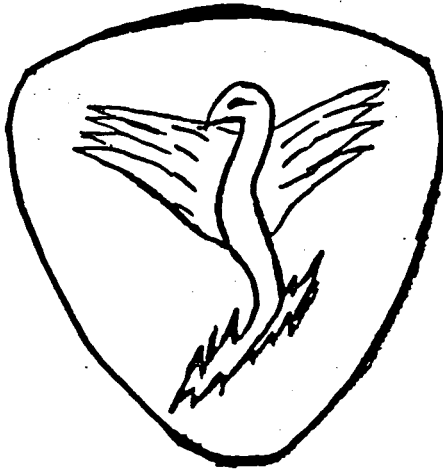

Handwritten symbols arranged in two vertical columns:

Column 1: 7, 4, 7, 7, 1, 1

Column 2: 7, 3, 3, 7, 4, 7

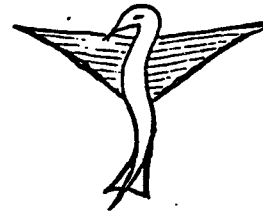

Emblem seen by
Bill Herrmann

Handwritten symbols: 7, 7, 7, 7, 7, 7



Emblem seen by
Herbert Schirmer

Handwritten symbols: 7, 7, 7, 7, 7, 7

The emblem and the symbols to the right have been seen by an abductee on board a craft and in the facility at Dulce, New Mexico. The emblem was worn on the right breast pocket of one-piece jumpsuits. Material is (c) C.Tilton, and is printed with permission.

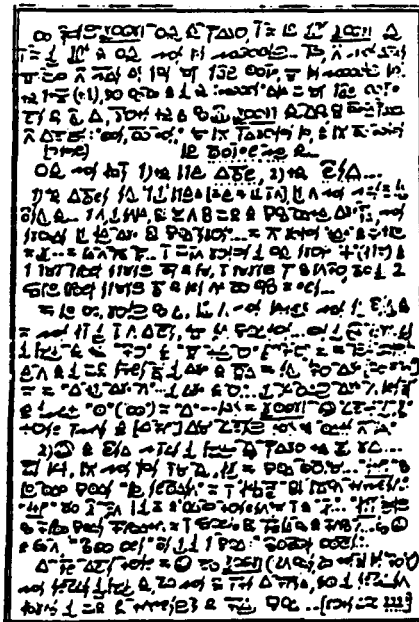

Handwritten symbols arranged in several lines:

7 3 8 DM
7 3 7 7
7 7 7 7
7 7 7 7
7 7 7 7
7 7 7 7

(c)1987,88,89,90 CRUX Publications.

The above sample of alien symbols were seen on craft panels and also in a book shown to an abductee.

Mystery object amid the chromosomes

Sir—The very tiny object shown below, much like a fragmented crossword in appearance, was recently found in one of our routine chromosome preparations for prenatal diagnosis following amniocentesis. But what is it?

Is it a man-made device? Packing text as binary coded information on the miniature scale (the scale bar is 10µm) would seem advantageous. Or is it a naturally occurring substance? None of the possibilities we have been able to think of would

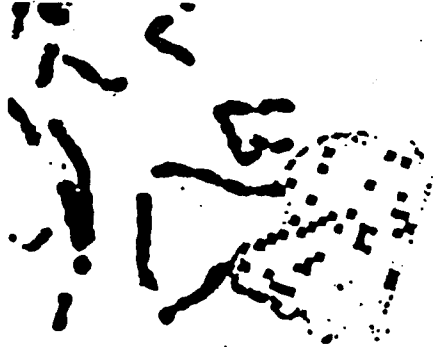

seem to be appropriate for amniotic fluid, so if anybody is able to suggest an answer to this mystery we would like to have it. We are as intrigued as we are ignorant.

JOHN WOLSTENHOLME
IAN HARLOW
GEORGE CLARKE
HILARY SHERIDAN
JON JONASSON
MARK CROCKER
HELEN MATTHEWS

Department of Medical Genetics,
Churchill Hospital, Headington,
Oxford OX3 7LJ, UK

ARTICLE FROM NATURE
MAGAZINE, 25 SEP 86

March 30-31, 57 Lights flashed in sequence as it landed. When it landed lights ceased to blink.

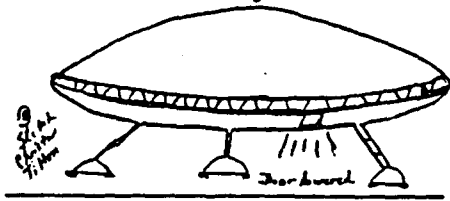

TOP: Craft seen by Christa Tilton in the early morning of 3-31-87, about 28 miles south of Tulsa, OK. She watched it land. The lights were bright and were flashing in sequence. The closer the UFO got to the ground, the slower the lights would flash. When the craft was 3-4 feet from the ground, the landing gear extended and a door underneath opened. The craft bounced gently as though on shock absorbers.

BOTTOM: The craft seen by Ashland, Nebraska policeman Herbert Schirmer in the Fall of 1967.

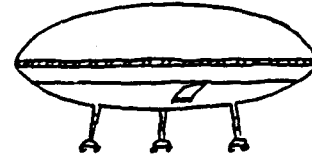

Craft seen by Herb Schirmer
Police Officer - Ashland, Nebraska

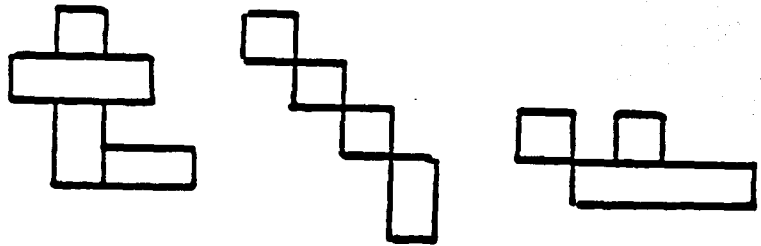

CRYSTALLINE METAL

DIAGRAM OF "CRYSTALLINE METAL"
FROM THE "DULCE PAPERS"

NOTES

CROSS SECTION VIEW OF
DULCE FACILITY

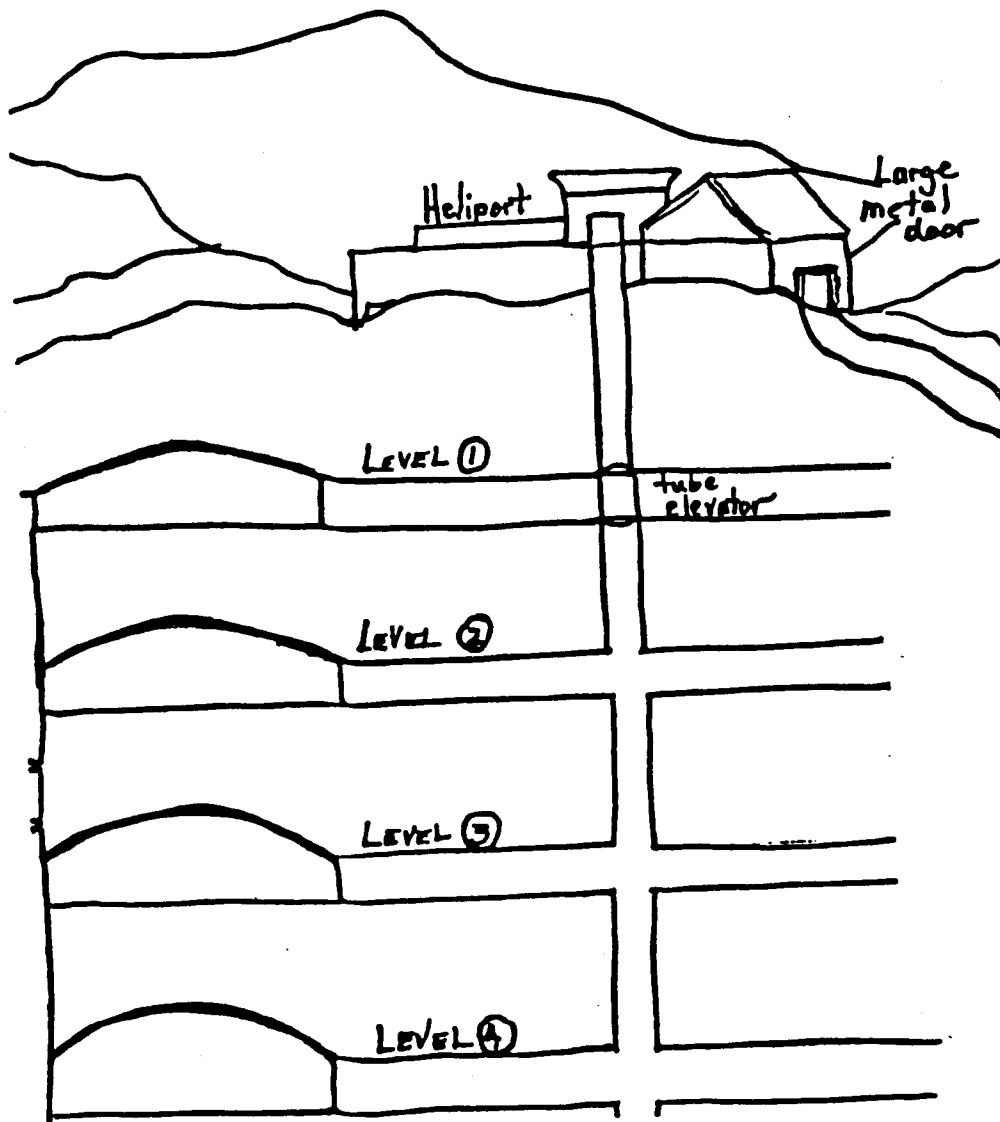

(c)1987,88,89,90 CHUX Publications.

**The Doraty Case
May 1980**

In May 1980, Judy Doraty was driving with her son on a rural highway near Cimarron, New Mexico. While driving, they observed at least two discoid craft in the process of abducting a young calf from a field. Both Judy and her son were abducted and taken aboard one of the craft and taken to what was apparently an underground installation, where the woman and her son witnessed the mutilation of the craft. Evidently, the aliens were either "interrupted" from processing the craft on the spot, or they sometimes make a practice of 'bringing home' their catch.

Judy Doraty observed a vat in the underground installation that contained various cattle body parts floating in a liquid. In another vat she saw the body of a male human. The woman was subjected to an examination in which small metallic objects were implanted into both her and her son. Medical catscans have confirmed the presence of these objects.

Researchers, primarily Paul Bennewitz, have collectively determined that the installation Judy Doraty was taken to was Dulce, since 1976 one of the areas that has been hardest hit by animal mutilations.

The mother and son were returned to their car the same night.

Since the incident, both have suffered repeated trauma and difficulties trying to recover from the incident.

One of the uses for the DNA and biologicals that the aliens are acquiring is the construction of synthetic humanoids. When they die, they do back into the vat. Their parts are recovered. Research seems to indicate that the Dulce facility began as early as 1948.

The Cash-Landrum Incident

This incident was well-publicized at the time. The newspaper article below goes into some of the overt details. Several "inside" sources have revealed, however, that this was one of the craft that the EBES gave to the U.S. Government, and that it was having critical problems that prompted its descent. The people involved were bathed in neutron radiation from the craft. It is interesting to note that in the next to the last paragraph of the article, the lawsuit changes to one claiming that the craft actually belonged to the government. Note the reference to 23 helicopters. Think about it....

San Francisco Chronicle

Monday, September 16, 1985

U.S. Contesting Lawsuit Over UFO Radiation

Houston

Three people suing the federal government for \$20 million say they do not know to this day what it was that hovered far over their heads and zapped them with radiation almost five years ago.

They claim it was an unidentified flying object that was escorted away by military helicopters. They say they suspect it was a secret U.S. military experiment. In any event, they say, the government should have warned residents that a UFO was in their area.

The military says it had nothing to do with the alleged occurrence Dec. 29, 1980, on a rural road northeast of Houston. Even if there were UFOs, a U.S. attorney says, the government has no duty to warn people about them because the government does not know whether they are dangerous.

With such straightforward arguments, the government is urging U.S. District Judge Ross Sterling to throw out a lawsuit filed here last year by former Dayton, Texas, cafe owner Betty Cash, 56, former waitress Vickie Landrum, 61, and Landrum's grandson, Colby Landrum, 11.

The suit claims that about 9 p.m. on Dec. 29, 1980, while headed for their homes in Dayton along a two-lane road about 30 miles northeast of Houston, the three encountered a brightly glowing craft the size of a city water tower. It hovered at treetop level, had red and orange flames flowing from its bottom, and bathed them in intense heat for several minutes before it was escorted away by at least 23 helicopters, they assert.

Their lawsuit, filed under the Federal Tort Claims Act, claims that the government failed to warn them of the UFO and "negligently, carelessly and recklessly" allowed it "to fly over a publicly used road and come in contact with the plaintiffs."

As a result, all suffered stomach pains, vomiting, diarrhea, radiation burns, deteriorating eyesight, and the women's hair fell out and grew back with a different texture, the suit claims. It also says they became highly sensitive to sunlight, suffered blisters and headaches, and that Cash developed breast cancer.

Despite the plaintiffs' report that there were no markings on the "large, unconventional aerial object" or on the helicopters, the lawsuit has recently moved from simply suggesting that the government merely knew about the UFO to saying that the government owned the UFO.

The government has offered affidavits from high-ranking officials that it had nothing to do with the UFO.

Staff Times Herald

G R O O M L A K E

A R E A 5 1

A N D T H E

N E V A D A T E S T S I T E

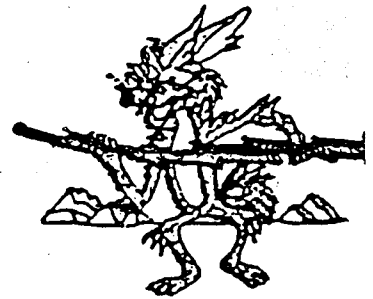
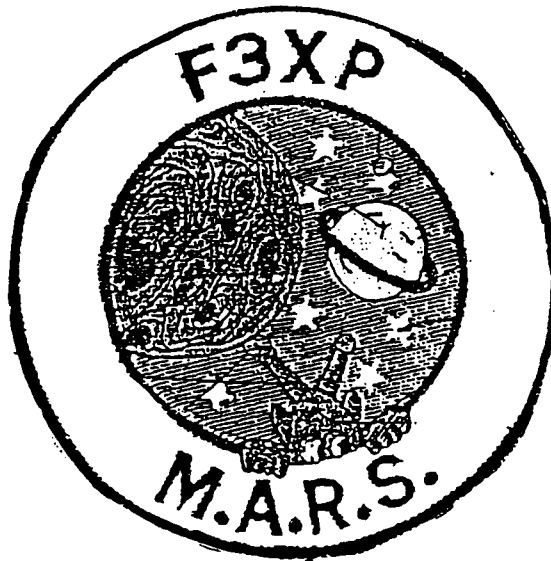

Alien Technology Division

The February 1987 issue of Gung-Ho, a popular military magazine, had a very interesting article in it regarding Stealth technology. Toward the end of the article, on page 43, it discussed projects called "UnFunded Opportunities" (UFO). The article bears quoting:

As for "UnFunded Opportunities", these are programs dealing with technology levels so advanced that one Air Force officer involved in SR-71 development said: "We are flight testing vehicles that defy description. To compare them conceptually to the SR-71 would be like comparing Leonardo da Vinci's parachute design to the space shuttle"

Other officers are similarly emphatic about the nature of these new systems: " We have things that are so far beyond the comprehension of the average aviation authority as to be really alien to our way of thinking," says one retired colonel.

Rumor has it some of these systems involve force-field technology, gravity-drive systems, and "flying saucer" designs. Rumor further has it that these designs are not necessarily of Earth human origin-- but of who might have designed them or helped us do it, there is less talk.

"Lets just put it this way," explained one retired Lockheed engineer. " We have things flying around in the Nevada desert that would make George Lucas drool."

Editor's Note and conclusion: The Air Force has had a unit at Nellis for several years; its name: Alien Technology Center. The first question is, do you think they are studying Mexicans? The center is rumored to have obtained alien equipment and, at times, personnel to help develop our new aircraft star wars weaponry, etc. Yes, I know I sound crazy, but the rumor is awfully solid! The Alien Technology Center is for real. Something remarkable has caused the Russians to suddenly want to play ball, and I personally believe this could be it. Sure, it sounds strange, but the most advanced known airplane in the world today (SR-71) was secretly flying in 1963-4. Do you really think our best, 23 years later, is the F-16?

Air Force will seek continued access restriction to secret base

By Christopher Beall
Review-Journal

It is perhaps the most secret military facility in Nevada, a place with a history of dark rumors and speculation, and a name that has even now become an object of folklore.

Lying about 85 miles northwest of Las Vegas, the base is an expanse of aircraft hangars, technical facilities and a 12,000-foot runway that rises above a dry lake bed in a desolate corner of the Nellis Air Force Range. The place has no official name, although it is unofficially referred to as Area 51.

The base's radio call sign for the Nellis air-traffic controllers who maintain the strictly restricted airspace overhead is "Dreamland." Even Nellis fighter jocks are not allowed to fly over Dreamland without difficult-to-get clearance.

The Air Force is preparing to defend a request, now dormant in

Congress, to keep almost 90,000 acres out of the public domain to protect the security of the base.

Rumors about the base have variously attributed the Stealth bomber development program or President Reagan's "Star Wars" missile defense program to it. There are also people who believe the remains of an alien spacecraft are stored at the facility.

The secrecy around the base was lifted briefly a few years ago when the Air Force illegally closed the 89,600 acres of public land on the Groom Mountain Range overlooking the base.

The Air Force said it needed to close public access to the Groom Mountain Range because if a person climbed into the mountains, he could have easy sight of the top-secret base.

There were rumors then that the base was the site of training for the failed mission to rescue Americans

from Tehran during the Iran hostage crisis in 1980.

There has also been speculation that the Groom Lake base is the center of the nation's Stealth bomber development program, with the initial tests and flight development for the supersecret, radar-defeating planes taking place over the desert range.

There is even a group of self-described UFO experts who say that Air Force memos indicate the shell of an alien aircraft that crashed in 1947 in New Mexico is kept at the facility.

However, most civilian defense watchers believe the Groom Lake facility is now the testing ground for many of the weapons that make up the Strategic Defense Initiative, known as "Star Wars."

When the first stories of the land withdrawal broke three years ago, most Nevada officials agreed that



CLOSED ROAD - A private security guard, who refused to identify himself or his firm, guards this road into the Nellis Air Force Range and the

top-secret Area 51 base. The Air Force will need to renew its withdrawal of the land around Area 51 for it to continue to post legal sentries.

Christopher Beall/Review-Journal

the federal government probably did need to take control of the land.

But they strenuously objected to the way it was done: The Air Force posted armed guards on the access roads and denied free passage to anyone without clearance, all in the absence of any approval from Congress or notification of the state.

When the closure came to light in 1984, after hunters and hikers were turned away from their traditional stomping grounds in the foothills around the Groom Mountain peaks, a Nevada political brouhaha developed.

Anti-nuclear protesters claimed that the land had been closed because it provided easy access for them to infiltrate onto the Nevada Test Site. And ranchers in the area complained that their traditional rights to graze cattle on the open public range were being usurped.

Then-Rep. Harry Reid, D-Nev., championed the cause of those hunters, hikers and ranchers as well as the Sheahan family, which operates a mine in the Groom Mountain.

Congress eventually approved the Air Force's request to withdraw the land from public access, but only after Air Force officials admitted their initial closure of the land was illegal.

That land withdrawal is now due to expire at the first of the year.

In the withdrawal bill, which set aside the 140 square miles to the west of Alamo and just outside the eastern boundary of the Nellis bombing range, the Air Force was required to prepare an environmental impact statement on the effects of the closure. The service was also required to prepare a list of proposals that would mitigate the loss of the land for the public.

That environmental report was finished last November, and it in-

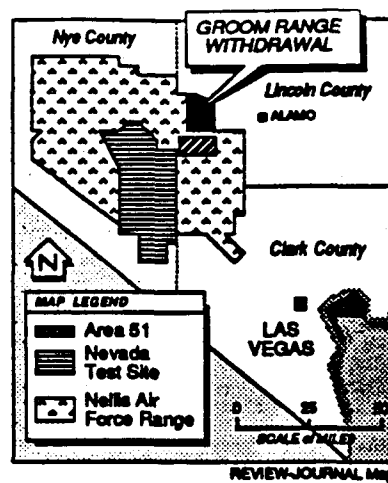

cluded a host of mitigation measures the Air Force said were not feasible and could not be recommended.

Some of the more extravagant plans that were not accepted called for the Air Force to spend as much as \$25 million to buy private land adjacent to the Red Rock Recreational Area in Clark County for public access and to spend \$11 million to improve the habitat of mule deer ranges in adjacent mountains in Lincoln County.

The recommendations the Air Force accepted include building watering guzzlers throughout Lincoln County for wild game and opening 26 square miles in the Stonewall Mountains for bighorn sheep hunting.

The Air Force has also said it would like to rebuild the road leading from Rachel into the Nevada Test Site, but it needs congressional funding for that proposal.

All these offers to mitigate the loss of the public lands will come up again for discussion as the Senate moves closer to hearing a bill to renew the withdrawal.

When the original withdrawal expires Dec. 31, the Air Force will again be caught in a position of closing access to the land illegally, unless the new bill is approved.

But Maj. Victor Andrijauskas, spokesman for Nellis, said the Air Force expects that the bill will be

passed and signed before the expiration date, and no legal problems will result.

No hearings have been held on the bill, and a spokeswoman for Sen. Reid said Reid has placed a legislative hold on the bill because of "serious concerns" about how the Air Force has handled the withdrawal.

"We are very concerned about how the Air Force has treated the Sheahans and their mine out there," Mary O'Driscoll said. "We

understand there have been a lot of problems for the Sheahan family and they are not happy about the situation."

"We also want to make sure the Air Force goes ahead with the plans for the Rachel road."

O'Driscoll said the legislative hold means no action can take place on the bill until Reid is satisfied with the Air Force's position.

Leaders with environmental groups in Nevada said during recent interviews that they are still

not satisfied with the Air Force's offers to mitigate the withdrawal, even though those leaders agree that the withdrawal is necessary for national security.

Bob Fulkerson said his lobbying group Citizen Alert does not oppose the renewal of the Groom Mountains withdrawal, but it does want more effort at mitigation from the Air Force.

"What they've proposed just isn't adequate," Fulkerson said.

HARRY REID
NEVADA

United States Senate

WASHINGTON, DC 20510

January 9, 1990

I appreciate the time you took to call me again. I am sorry you did not receive my letter responding to your inquiry concerning Area 51.

As you know, that area is highly restricted and highly classified. Government agencies do not engage in extra-terrestrial research programs, nor does the National Aeronautics and Space Administration (NASA).

With all best wishes,

Sincerely,

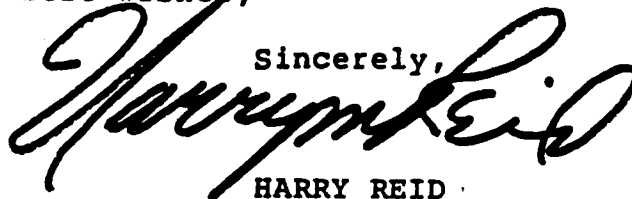

HARRY REID
United States Senator

HMR:jvc

Senator Reid: One would suppose that the people who publish the Federal Register would know, as would NASA, who engaged them to publish this ----->

3384. EXTRATERRESTRIAL EXPOSURE

Legal Authority: 42 USC 2455; 42 USC 2458; 42 USC 2473; 18 USC 799

CFR Citation: 14 CFR 1211

Legal Deadline: None

Abstract: Revision updates the existing regulation to conform to current agency practices.

Timetable:

Action	Date	FR Cite
NPRM	10/00/89	

Small Entities Affected: None

Government Levels Affected: None

Agency Contact: Stephan W. Fogleman, Office of Space Science and Applications, Code EB, National Aeronautics and Space Administration, NASA Headquarters, Washington, DC 20546, 202 453-1530

RIN: 2700-AA53



SIERRA CLUB

Toiyabe Chapter - Nevada and Eastern California

December 28, 1985

Captain Donald Zona
HQ TAC/DEEV
Langley AFB, Va. 23665

Dear Captain Zona:

The Sierra Club has participated in Congressional, Scoping, and EIS hearings on the Groom Mountain Range land withdrawal. Written comments are being provided on the EIS. Oral statements have been made at both the Scoping and EIS hearings in Las Vegas. A written proposal covering a proposed mitigation measure for the land withdrawal has previously been supplied at the Scoping hearing.

The previous statements and comments from the Sierra Club and its members have focused on the legality of the land withdrawal, the environmental impacts, and possible mitigation measures. These items will be covered again for the record in the context of whether the present EIS is adequate in analyzing the impacts of the land withdrawal on the environment and on the coverage of the mitigation measures.

Public law 98-485 (October 17, 1985) granted the Air Force temporary authority to restrict public access to 89,600 acres of BLM land east and northeast of Area 51 of the Nellis Air Force Range. As previous testimony has pointed out, this land has been deemed by the Air Force as being important for the national defense.

The decision to control access was made at the local level after consultation with local Bureau of Land Management officials and after Headquarters, Air Force conferred with the Air Force Secretariat. After the controls were implemented, briefings were conducted for the appropriate personnel within the Offices of the Secretary of the Air Force and the Secretary of Defense. Additionally members of the National Security Council were also briefed. [Hearing before the Subcommittee on Public Lands and National Parks of the Committee on Interior and Insular Affairs, House of Representatives, August 6, 1984]

Testimony before the House Subcommittee on Public Lands and National Parks on August 6, 1984 included some discussion of the need to control access to the area for national defense purposes; however, a focus of the testimony was on the legality and manner in which the Air Force was attempting to restrict access to the BLM land. Specifically, the distinguished chairman of the subcommittee questioned: "Is it true that the Air Force has already acted to restrict public use of the Groom Range area?"

The honorable John O. Rittenhouse, Deputy for Installations Management,

To explore, enjoy, and protect the natural mountain scene...

Office of the Deputy Assistant Secretary, U.S. Air Force responded:

Yes, sir, it is true. We have asserted the right to control the surface access and egress to the extent of requesting people not to go in and out. We have people posted on the roads and at certain times we do not. We ask their cooperation.

Mr. Seiberling. Under what legal authority was that done, that right asserted?

Mr. Rittenhouse. As far as I know, sir, there is none; except decisions were made at a much, much higher level than mine that that be done.

Mr. Seiberling. There is no higher level than the laws of the United States.

Mr. Rittenhouse. No, sir. I understand, and we can describe that further if you would like, sir.

Mr. Seiberling. I would like.

Mr. Rittenhouse. In closed briefing

Mr. Seiberling. What has to be why would that have to be in a closed briefing?

Mr. Rittenhouse. I can't discuss it, sir.

Mr. Seiberling. Shades of Watergate. All I am asking you is under what legal authority this was done. I am not asking you the technical reasons. That certainly is not classified.

Mr. Rittenhouse. . . . as I stated earlier, originally we had no legal authority but we asserted the right to request people to not enter that area.

Mr. Seiberling. Now?

Mr. Rittenhouse. We legally did not have the authority.

The authority to withdrawal over 5,000 acres of public land from public use is covered by the Eagle Act, and this requires Congressional approval for such a withdrawal. As the testimony above indicates, the Air Force did not have legal authority for their actions, and Congress through the passage of Public Law 98-485 authorized a two-year withdrawal of the land from public use with the provision that an EIS be developed to analyze the impacts and possible mitigation measures.

Public Law 98-485 in calling for an EIS stated:

Such statement [EIS] shall include a description of and recommendations concerning measures to mitigate the impact of such continued or renewed withdrawal on opportunities for outdoor recreation, mineral exploration and development and agriculture in Nevada. Such measures shall include possible acquisition by the Secretary of the Interior (through exchanges or otherwise) of lands in Nevada suitable for outdoor recreational uses and possible increased mineral, agricultural, or recreational use of lands in Nevada withdrawn for military purposes.

**PUBLIC HEARING
FOR RENEWAL OF
GROOM MOUNTAIN RANGE
LAND WITHDRAWAL**

NOVEMBER 19, 1985

7 P.M.

CALIENTE, NEVADA

REPORTED BY:

HOLMES & HARVER, INC.

REPORTING DIVISION

In other words, the purpose of this action is allegedly for national defense. I think any alert, educated citizen knows the approximate quantity of missiles the United States has, and therefore, this activity being considered is totally and absolutely irrelevant and unnecessary. Thank you for participating in this democratic process.

COLONEL LACY: Thank you, Mr. Vogel. Before we move into the question period, I'd like to note that we were given another written statement to be attached to the record from Ms. Becky Parr of Las Vegas, and that will be a part of the record.

At this time -- and I assume this microphone is open -- I would like to call on anyone who has questions for any of the agency representatives, or again, for that matter, for any of the speakers to please so indicate by raising their hand. I'll recognize the first ones I see, and you may approach the microphone and ask your questions; and we will then delegate those questions to the person who is familiar with your area of concern. Questions?

MS. AVIS SHEAHAN: I have a question.

COLONEL LACY: Yes, ma'am. Would you please come to the microphone and please state your name and address.

MS. AVIS SHEAHAN: My name is Avis Sheahan, and I am from the Groom Mine; and it's my understanding we are not a part of the withdrawal. We own our land, we are not a part of BLM. I don't understand how

or why we have to discuss access with you at all under those circum-
stances. It's ours, and we have a right to go there, and --

COLONEL LACY: Ma'am --

MS. AVIS SHEAHAN: -- how can you control us?

COLONEL LACY: -- do you have a question?

MS. AVIS SHEAHAN: Yes, how can you control our access unless you
own the land? And if you're not withdrawing our property, how can
you control our access?

COLONEL LACY: Can a representative of BLM answer that question?

MS. AVIS SHEAHAN: Without a gun.

COLONEL LACY: Dr. Cochran or -- or Colonel Smith?

COLONEL SMITH: I'll take the question. Colonel Bob Smith. I think
the problem is more in the purview of the Air Force than the BLM.
In fact, I think they would agree with that.

The access that is being controlled is controlled by the legal
authority that was presented under the law adopted, in which the
comments that the United States stated, that access would be con-
trolled by the Secretary of the Air Force.

MS. AVIS SHEAHAN: On the BLM land, yes, but our land is not BLM
land.

COLONEL SMITH: Well, ma'am, you're correct. But access to land is
by the --

MS. AVIS SHEAHAN: But why are you discussing access to our land in
your Environmental Statement regarding BLM land? That's my question.

COLONEL LACY: I believe the answer to that will be addressed in the final EIS. Yes, ma'am. You don't have to come to the microphone.

MS. SHEAHAN: I have a real loud voice.

COLONEL LACY: I didn't say that.

MS. SHEAHAN: I'd like to know how the military can hide behind the guise of national security when you have broken all of the rules that's supposed to ensure this country's freedom, denying our access, holding us at gunpoint when you feel necessary, not telling people you're withdrawing it for our own good. I mean, is it because we're too stupid, or what? I would really like to know.

COLONEL LACY: That's a rhetorical question that I'm afraid can't be addressed here, or in the draft, or in the final EIS.

MS. SHEAHAN: Why? You can't tell me why you've broken all the rules? And you say it's national security.

COLONEL LACY: We're not going to engage in a debate over rule-breaking. That is a rhetorical question, it's not a question seeking legitimate information, so, it won't be answered.

MS. SHEAHAN: All right.

**PUBLIC HEARING
FOR RENEWAL OF
GROOM MOUNTAIN RANGE
LAND WITHDRAWAL**

NOVEMBER 20, 1985

7 P.M.

ALAMO, NEVADA

REPORTED BY:

HOLMES & HARVER, INC.

REPORTING DIVISION

There's not anywhere near any adequate information regarding the need for this proposed program. I think that if I were a typical congressman, without some special top-secret briefing, I'd say, I don't see any reason why you need it; I don't see why a remote mountain range in central Nevada is a risk to the national security.

Concerning the affected environment that is being discussed in this thing, I think that the exact -- the areas of importance are minimized as much as possible, and I think that it gives a rather -- you don't get a very good picture of the area. I think you need more information comparing these resources to other resources that occur in a desert area.

You have a mountain range that's 9,000 feet tall or taller, that is forested, that has water, is a beautiful camping area, is a good place for livestock and recreation; it has a lot of interesting features which are not to be found in most of Lincoln County. I think there should be more comparative information as to the value of this resource.

To get back to the point I made earlier: If there are serious impacts on the environment resulting from a no-action alternative, in other words, if the public safety and the national security would be jeopardized, why did the Air Force not tell us so in 1981 when they withdrew the Nevada Test Site? They did not at that time indicate that there were any activities going on in the Test Site that caused an impact to the national security and the public safety which would result from trying to keep people out of the Groom Mountain Range, which they were already doing at that time. So, I think that's another reason why we would question the information that's presented here.

COLONEL LACY: Excuse me, your three minutes is up, but I'll give you approximately 30 seconds to conclude.

MR. BENEZET: All right. Given the remoteness of the area, and also some of the information included in this DEIS, I wonder if it isn't possible that this area might be a potential wilderness area if it weren't for the Air Force's presence next door; and given the remoteness of the area, if access were available to people on foot, I doubt if anybody would be toting in surveillance equipment to the top of a 9,000-foot mountain and causing any serious threat to the national security. So, that's a possible alternative action which is not included.

COLONEL LACY: Thank you very much, Mr. Benezet. I've concluded that the real reason you followed us here from Caliente was to get warm. It was cold out there.

MR. BENEZET: It's been surprisingly cold in Las Vegas, I think.

13 Dec 85

TO: Captain Donald Zona
Hq TAC/DEEV
Langley AFB, VA
23665-5001

Comments regarding Groom Mountain Range Draft Environmental Impact Statement (DEIS) and Mitigation #11

Early in 1984 the Air Force Illegally seized 89,000 acres of public land called the Groom Range. This act was legitmatized by H.R. 4932 and S. 2657 introduced 23 Feb 84 and 10 May 84 respectively. The Air Force used as its authority to occupy (seize) P.L. 98-485 approved 17 October 1984. All these dates are AFTER the seizure

In the blue pamphlet handed out to the public at the open meetings of 19, 20 & 22 Nov. 85 and in the DEIS, the Air Force rejects the mitigation to purchase private lands to expand Red Rock Recreation lands in Clark County as not related to withdrawal, estimated recreation loss or cost prohibitive. To begin, it is not the intent of this mitigation to expand anything. What this mitigation is trying to achieve is to avoid a visitor standing by the Visitors Center, after getting good information about the geology, flora etc. of the area, stepping outside the door and seeing a shopping center or another development. What we are looking for is a buffer zone.

If the Air Force would consider the mitigation in the context of the Santini-Burton (S-B) Bill, none of these rejections would be valid. The S-B Bill is essentially a two-step exchange. 1. The Air Force buys the Groom Range with the money placed in escrow. 2. Escrow to buy critical private Nevada lands. A good purchase could be those SUMMA Corp. lands near Red Rocks Recreation Area. This area being just outside Las Vegas, a major population center and a rapidly expanding one.

My question is why wasn't this mitigation considered in the context of the S-B Bill

Sincerely
Walter Barbush

December 30, 1985

Captain Donald Zona
HQ TAC/DEEV
Langley AFB, VA 23665-5001

Dear Captain Zona:

Thank you for this opportunity to comment on the Air Force's DEIS for renewal of the Groom Mountain Range land withdrawal. I attended the public hearing at Clark County Community College, Las Vegas, in November to express my feelings. However, due to the limited time available to speakers there, I feel the need to amplify my brief statement now in writing.

There are a number of "small" flaws in the DEIS. For example:

1. On page 1-1 the first statement is that the Air Force proposes "to renew the withdrawal of 89,600 acres, more or less..." Given the seriousness of this issue, I believe you could be somewhat more specific than "more or less."

2. Page 3-27's first paragraph states that "The State Historical Preservation Office will be consulted." Why wasn't it already consulted? If you haven't gathered as much information as possible about the proposed area, how can you fully study the potential impacts?

3. On page 4-6, the second paragraph shows faulty logic in progressing from the statement that the Groom Mountain Range mineral properties are "owned by families or individuals who may not (emphasis provided) have the financial reserves required" to the statement that "Future mineral activity...is (emphasis provided)...dependent on the lease or sale of properties to major mining companies." Logically speaking, a possibility does not result in a definite outcome.

4. On page 4-16 you state that the cost for purchase of private land near Red Rocks would be "from approximately \$4,000,000 to \$25,000,000" but you repeatedly refer orally and even in other places of the document to a cost "upwards of \$25 million." This is misrepresentation of the grossest kind.

Much more serious, however, is the entire attitude assumed by the Air Force throughout the document. As Congressman Reid stated, you seem to have treated the requests by citizens for compensation simply as an unrealistic "wish list." Your evaluation of the proposed mitigation measures is totally frivolous, and you dismiss almost all of them out of hand on extremely flimsy bases.

You fail to give any serious explanation for the reasons each of the mitigation measures is dismissed. On page 4-14 regarding potential mitigation no. 6, you state simply that "This mitigation measure is not recommended for implementation." At the briefing at the public comment meeting, you showed a chart supposedly summarizing the document. The chart stated that this measure was too expensive and that's why it was rejected. Your speaker who was conducting the hearing stated that it was rejected because it was not mitigation of a direct impact. It seems the real reason it was rejected is simply because you had decided to reject almost all mitigation measures. An EIS is supposed to provide a complete evaluation and explanation--yours certainly fails to do that, and we are left wondering why you rejected things. Your "logic" is supposed to be open for public review, and the EIS is clearly inadequate to allow that.

This issue of some mitigation measures being rejected because they are not mitigation of a direct impact was used often in your document--for example, to support rejection of Potential Mitigation No. 16, transfer of BLM land in Clark County for a Veterans Cemetery. Such an argument fails to consider the illegal nature of the Air Force's seizure of this land in the Groom Range and the fact that increasing military withdrawals of land in Nevada is greatly decreasing the public's access to "public lands." In such circumstances, the provision of additional land for public use is indeed "related to the withdrawal."

You repeatedly state in your document that certain mitigation measures are rejected because they are too costly. The final result of your DEIS is to recommend one mitigation measure at a cost of \$88,000--i.e. you want to retain control of the land you illegally seized and compensate the public at the rate of less than one dollar per acre. That certainly seems too cheap to any fairly thinking person!

Finally, you seem to have totally disregarded the impact of the seizure on the public's potential access to public land. You give figures of the usage Lincoln County residents make of the area and the potential impacts of Lincoln County growth (for example, see page 1-7 and 1-8). However, you dismiss any usage Clark County residents will make in the future. An EIS is to consider present and future impacts. It is clear that the population of Clark County will continue to grow. It is also clear that outdoor recreation is ever increasing in popularity. These two factors, especially in conjunction with each other, show that there clearly will be increased demand from Clark County in the future for recreational opportunities outside the County. Such opportunities are being curtailed by your retention of this land formerly open for public use. Yet you totally fail to consider this impact.

The only thing you seem truly concerned about in this document is "national security." Yet you completely fail to define the criteria for such needs. It is therefore impossible for a person to evaluate the various mitigation measures and the potential actions in terms of need. For example, perhaps the national security needs of the withdrawal can be met through withdrawal of a lesser area. We are all Americans and we are all concerned with national security. However, we cannot put national security up on a pedestal and say that everything else must bow before it. Again, as stated above, you must present all the relevant information in your EIS so that the environmental impact can truly be understood and evaluated. This clearly was not done, resulting in an inadequate and biased EIS that appears to have been written strictly to comply with Congress' order that you prepare an EIS--producing paperwork but not the information which was the whole point of the order. It certainly needs a lot of revision before the final EIS is issued!

Sincerely,

Cher Cushman

Radio Frequencies

Holloman AFB	324.3 MHZ UHF	Approach
	255.9 MHZ UHF	Departure

Holloman White Sands Test Net

260.8 MHZ UHF	Primary
264.9 MHZ UHF	Secondary
9.023 MHZ USB	HF Link
262.925 MHZ UHF	Sat Link
397.9	In use
353.6	In use
364.2	In use
376.1	In use
189.4	In use
251.1	In use

**Call signs: Sierra Papa, Sierra Pete,
Ringmaster, Battlestaff, Guardian Papa,
Dark Star, Dark Star Oscar**

Roswell AFB, NM	239.6 MHZ UHF	Approach
	272.7 MHZ UHF	Tower
	305.6 MHZ UHF	Primary Military Net
	397.9 MHZ UHF	Second Military Net
	259.2 MHZ UHF	In use
	305.6 MHZ UHF	In use
	348.7 MHZ UHF	In use

Nellis AFB, NV	279.7 MHZ UHF	Approach
	324.3 MHZ UHF	Tower
	275.8 MHZ UHF	Ground Control
	289.4 MHZ UHF	Clearance Delivery
	270.1 MHZ UHF	ATIS

255.8 MHZ UHF	Dreamland Base
343.0 MHZ UHF	Sally Corridor
361.3 MHZ UHF	Groom Lake Approach
297.65 MHZ UHF	Watertown strip

Edwards AFB, CA	269.9 MHZ UHF	Tower
	304.0 MHZ UHF	Command Post
	121.8 MHZ UHF	VHF Gnd Control
	318.1 MHZ UHF	Approach



HWY 375 (OFF HWY 93)
MILE MARKER
29 1/2

LOOKING SOUTH
TOWARDS GROOM LAKE.
- DIRT ROAD TO
STEVE MEDLIN'S RANCH

29 1/2
"ZOOM SHOT"
"UFO" ACTIVITY AREA.

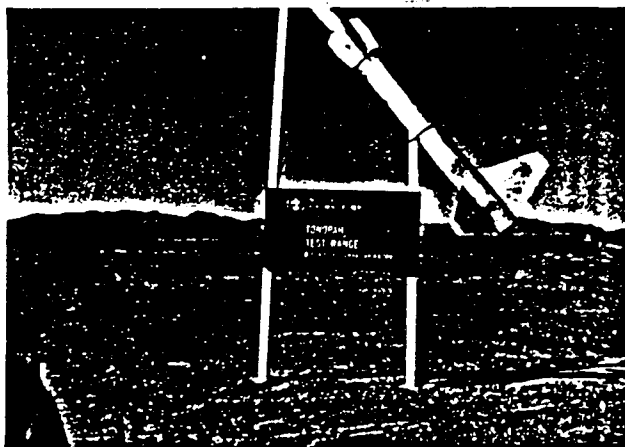
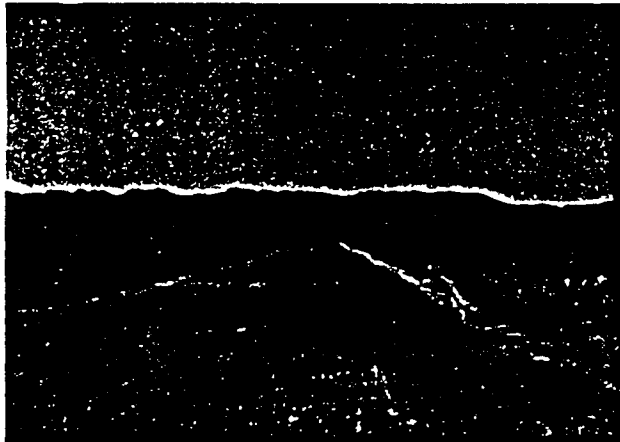

ENTRANCE SIGN
TO TONOPAH TEST
RANGE —
NOTE :
* SANDIA LABS
* RED STAR ON ROCK.

NEVADA LOCATION MAP FOR GROOM LAKE FACILITY

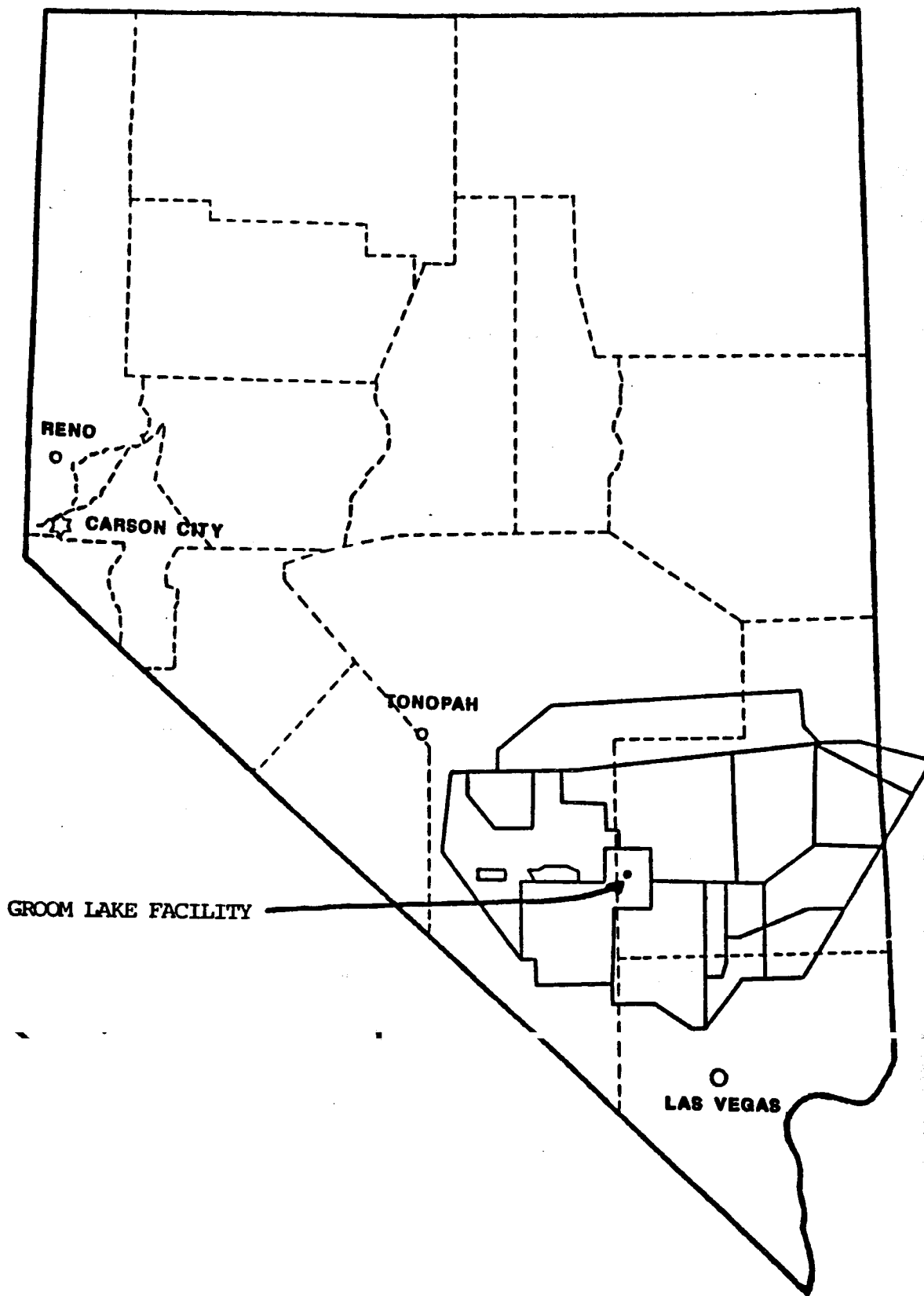

Soviet Satellite Photograph of Groom Lake



Topographic Map of Groom Lake

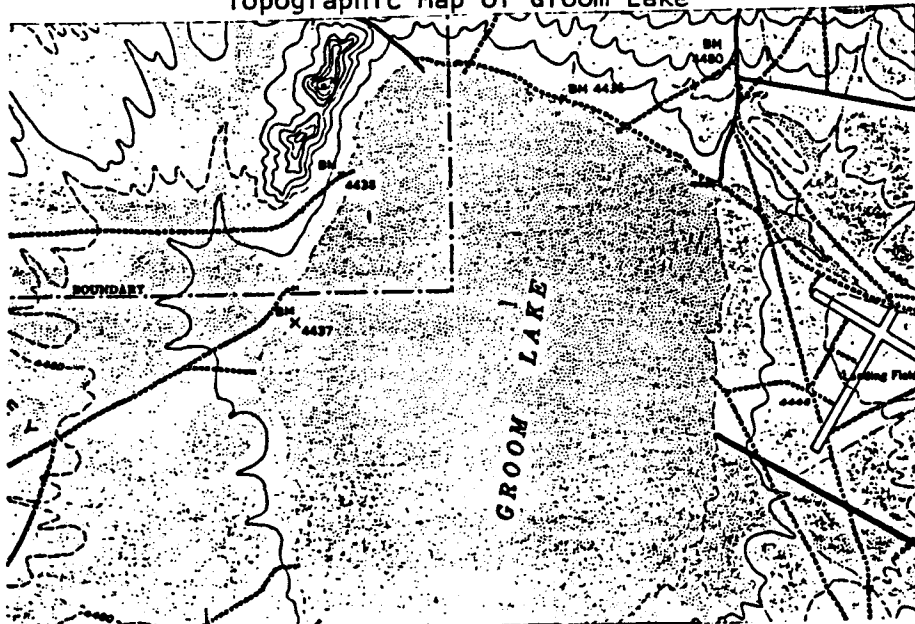

HYPOTHETICAL CONFIGURATION OF TUNNELS
AND GRAVITY ANOMALIES
DATA REPOSITORY ESTABLISHMENT AND MAINTENANCE
(D.R.E.A.M.) LAND

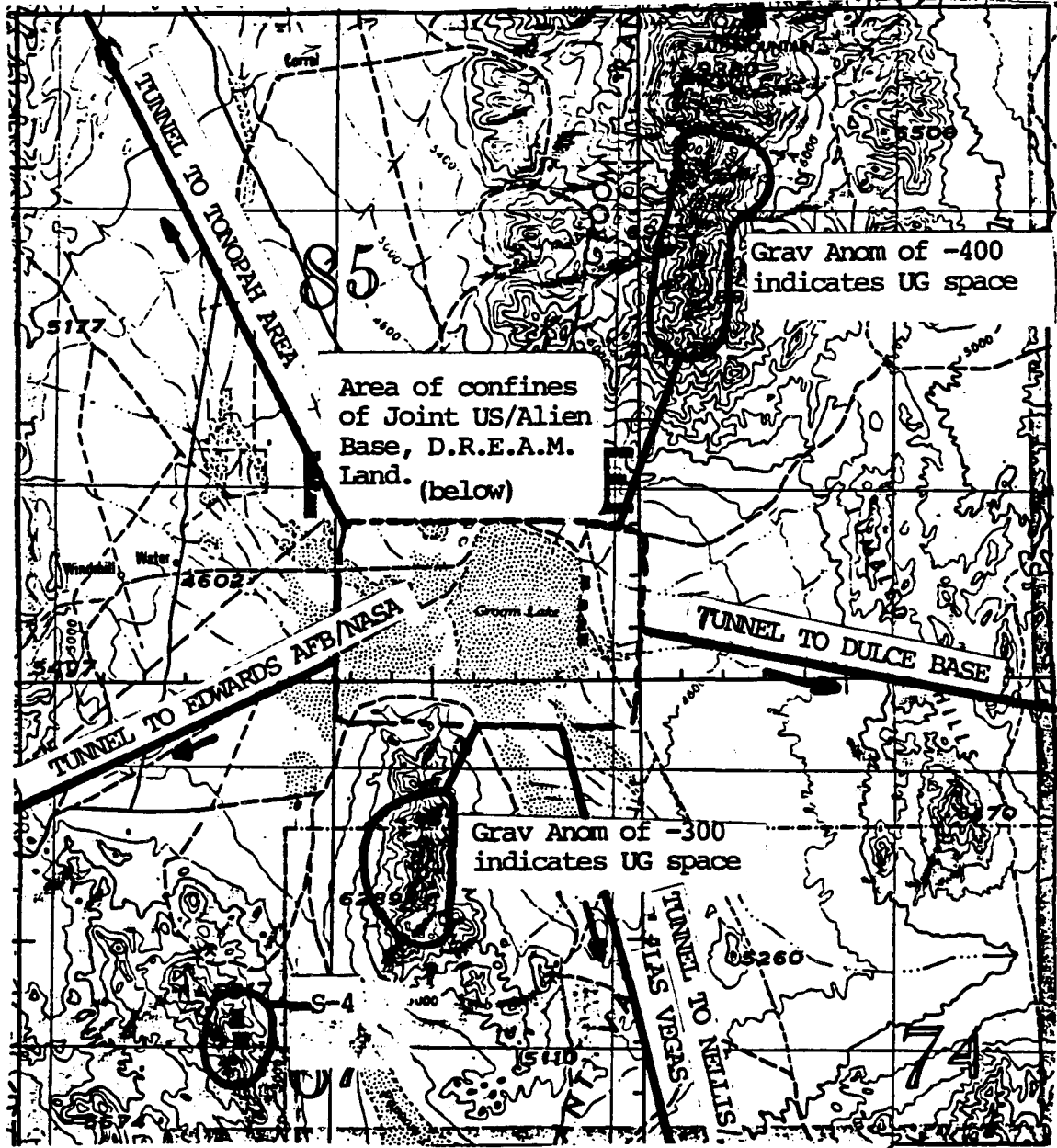

GRAVITY ANOMALY MAP OF GROOM LAKE AREA FROM US GEOLOGICAL SURVEY
NEGATIVE FIELD AREAS INDICATE UNDERGROUND HOLLOW AREAS

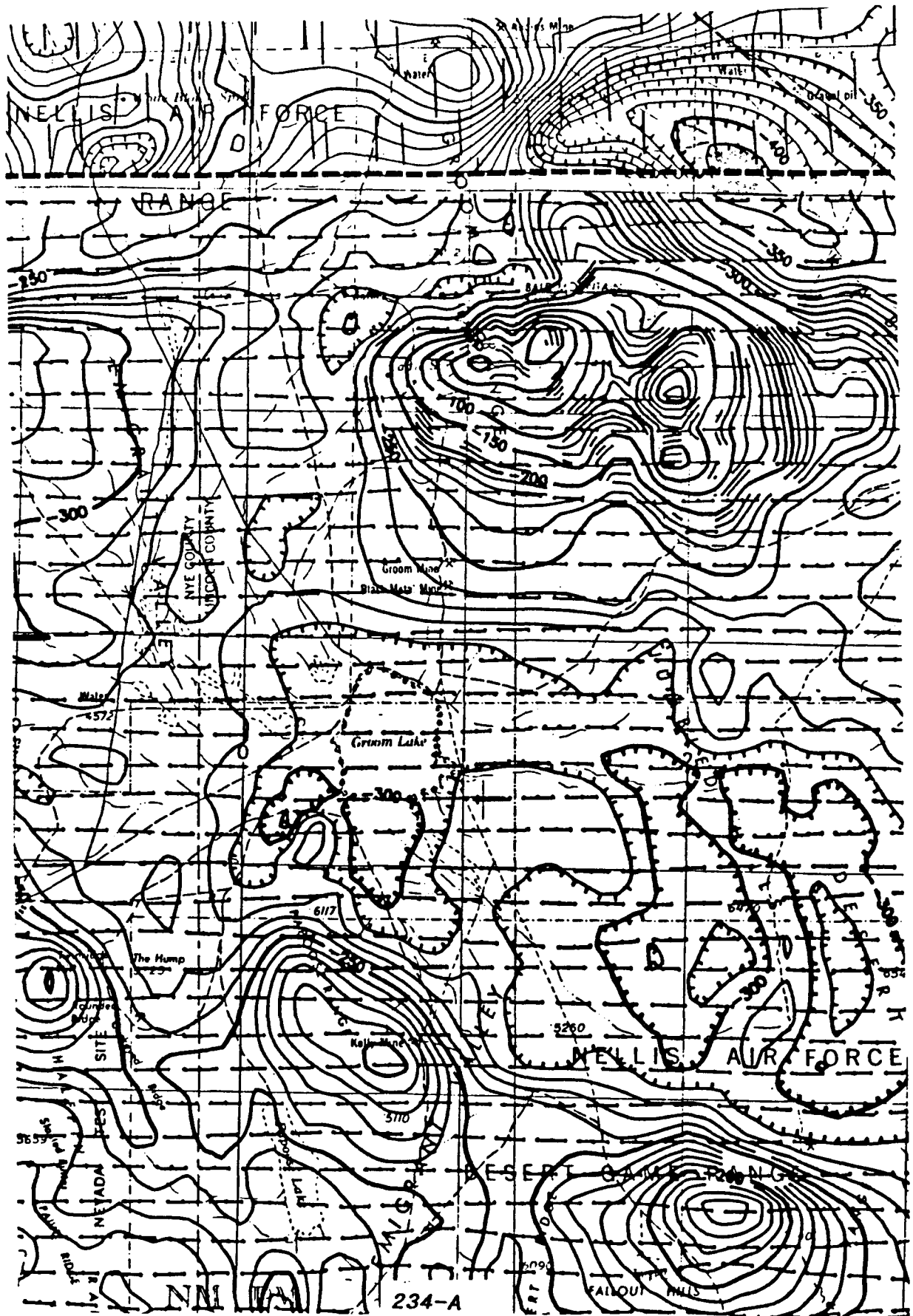

NEVADA US-ALIEN FACILITY BRIEF

After several years of painstaking research, we have unearthed the high possibility of EBE base areas in the Nevada Area. Observations from many individuals, some of whom have been threatened by various parties, have led to the following conclusions:

- * Several facilities exist within a 100-mile radius of the Las Vegas area that are EBE operated or related.
- * Underground Tunnels exist between facilities and these tunnels have been constructed by or with the assistance of the EBEs.
- * Electromagnetic confinement zones have been set up at various locations, and one of these locations encompasses the Nevada Test Range Complex.
- * Further interior electromagnetic confinement zones have been constructed within the primary zones.
- * Bureau of Land Management (BLM) equipment doubles as confinement field projectors.

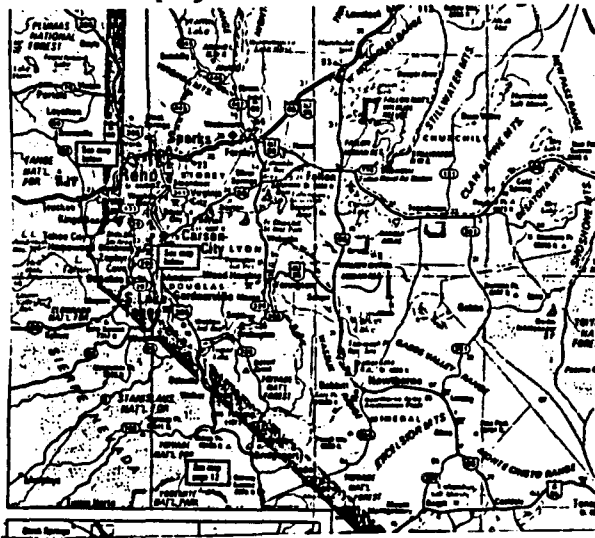

Nevada Test Site EBE Electromagnetic Confinement Zone. Approximate limits to area. Actual projector coordinates are:

35 39'
114 51'

38 21'
115 35'

37 21'
117 52'

See Below

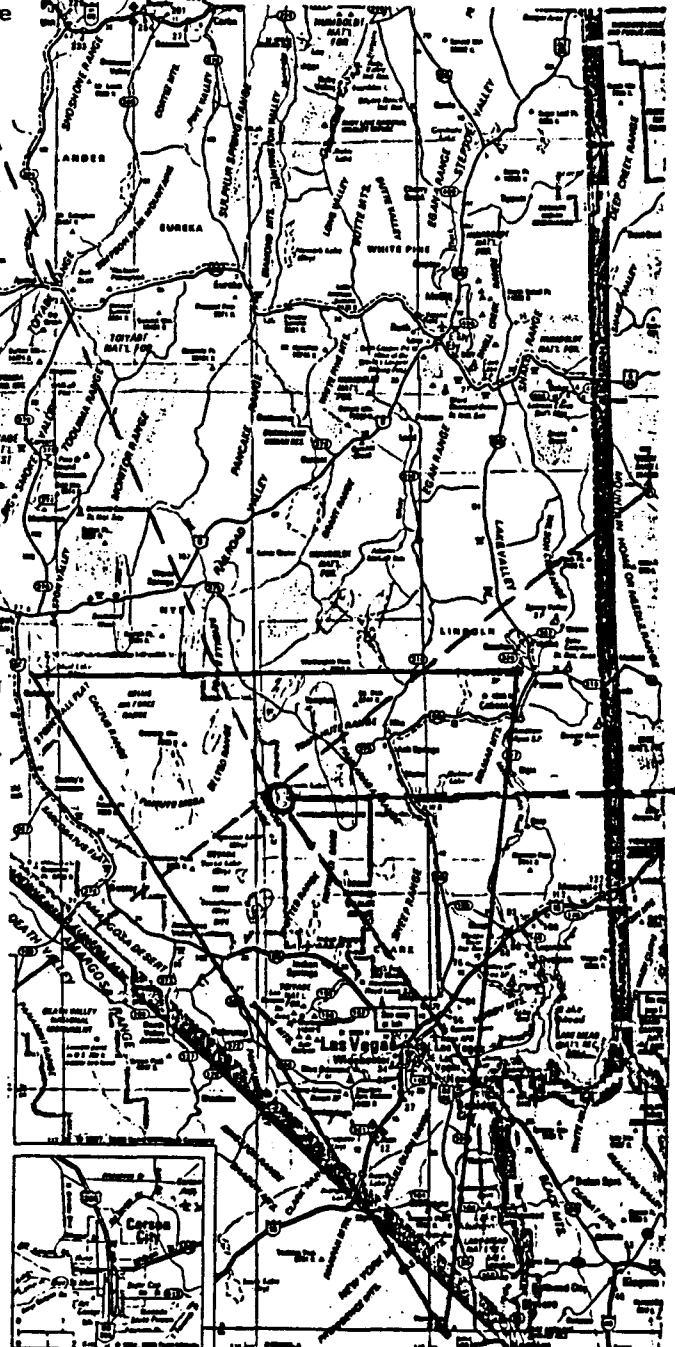

- * Underground facilities in the area have the following functions:
 - * Testing and development of Defense Space Weaponry
 - * Cloning of human replacement bodies that will be occupied by implanted consciousnesses.
 - * Breeding laboratories for abducted human females.
 - * Biological Material processing laboratories.
 - * Confinement facilities for humans.
 - * EBE-Govt Joint Facilities.
 - * Facilities for Termination of Humans.
 - * Facilities for Testing and Development of Gravitational Vehicles for USAF,NSA, and the Department of Commerce.
 - * Transference Facilities for Human abductees.
- * Vortex areas serve as entry-exit points for various aerial vehicles. Vehicles as large as 200' diameter have been seen for a long time at the Jumbo Peak vortex area. Blue Diamond vortex area is also very active, and as of June 1988, disks have been seen during daylight hours.
- * The metropolitan Las Vegas area is filled with MIB related activity and various humanoids that are observing human activities.

What follows are various illustrations of some of the areas mentioned above.

COPY

0000023000001100000050000023:50GMT
FLD.REP.SAC/OSI-CR44
0001140004800015000003700000000000
0000000440000000120000000000CRTAFOSR/OSI
0000000012:SCRAM/TEXT:55:120000000
TRANS.INITIATE:
0005:

ATTN:CD'ED. PASSAGE.DIR.MAJ12-44:85/86
CR/CR44/CR-MJ12/4412
00000012:44
CR/CR44/CR12/MJ44/MJ12
LOC:J330
ORIG.:J330/HAFB/341STSMW/C5G

FBI FLD. OFFICER/SAC:009221/CR44/12

SCRAM.COMM.PAC.FLD.OPP.

to: SAC MID/AM.LOC.
114° 48' 15" 37° 00' 00"
00000000044000000004400000

IMMEDIATE ACTION.MIN.CONTACT.INFORM IMMED.

I M P O R T A N T:

APPROACH AREA WITH EXTREME CAUTION
NO MEDIA EXPOSURE.
NO MEDIA EXPOSURE.

DISPATCH MED/REACT TEAM IMMED.

LOCAL AUTH. CO-OP. PER CR44/MJ12/PENT.5512.552.2

END/PAC.FLD.COMM.
LOCTIME:23:50GMT
COMM/TERM.

CR44

SITE OF ALIEN RECOVERY EVENT
(See Message on Previous Page)

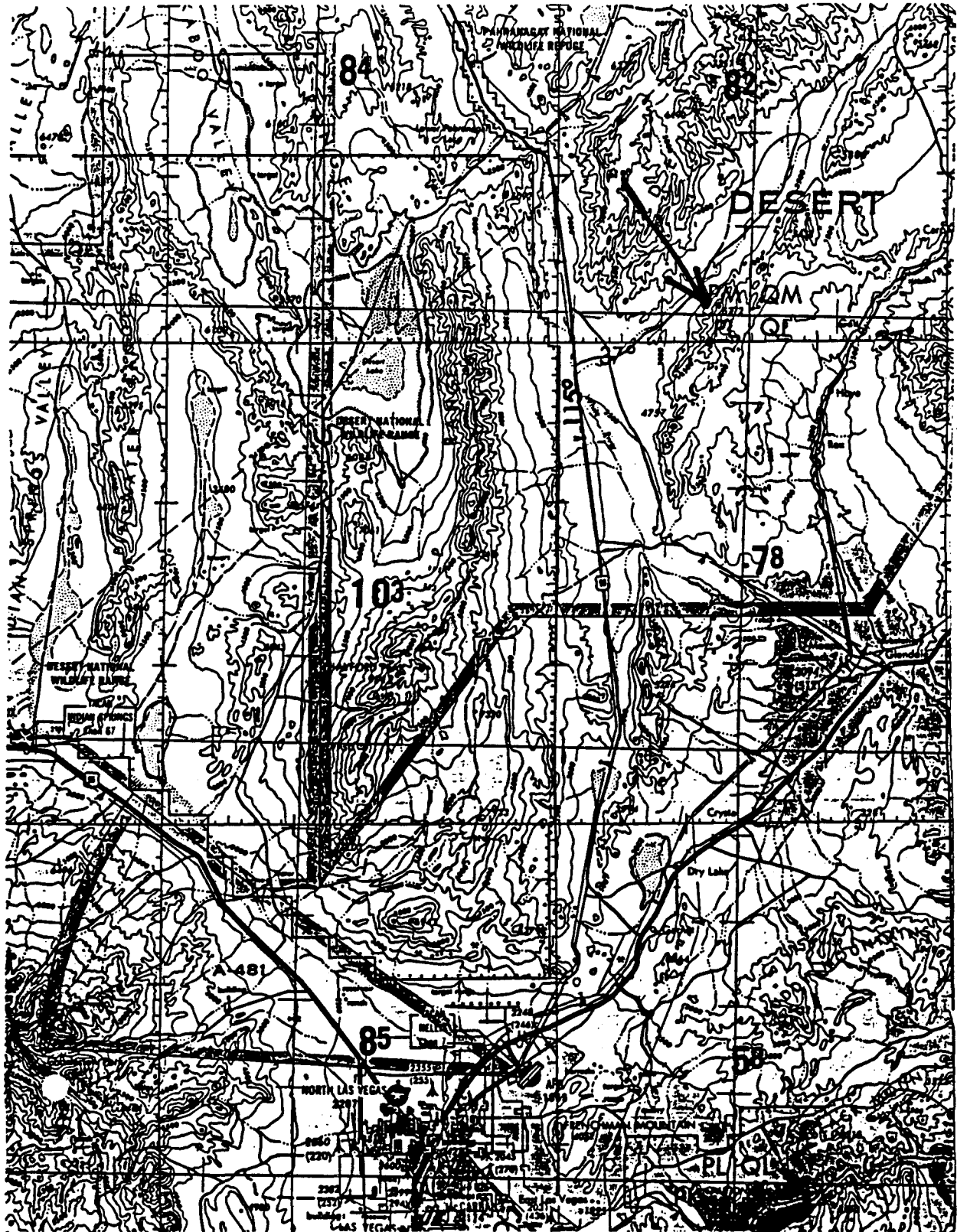

JOHN LEAR

The following statement is a 'working hypothesis' written by John Lear on December 29, 1987 and revised on January 14 and again in March. This revision is dated August 25, 1988.

John Lear is a Lockheed L-1011 captain for a major US airline and has flown over 160 different types of aircraft in over 50 different countries. He holds 17 world speed records in the Lear Jet and is the only pilot ever to hold every airman certificate issued by the Federal Aviation Administration. Mr. Lear has flown missions worldwide for the CIA and other government agencies. A former Nevada State Senator candidate, he is the son of William P. Lear, designer of the Lear Jet, the 8-track stereo and founder of Lear Siegler Corporation. Lear became interested in UFO's in the summer of 1986 after talking with United States Air Force personnel who had witnessed a UFO landing at Bentwaters AFB, near London, England, and three small aliens walking up to Wing Commander Gen. Gordon Williams.

August 25, 1988

THE UFO COVER-UP

by

John Lear

The sun does not revolve around the earth.

The United States government has been in business with little gray extra-terrestrials for about 20 years.

The first truth stated here got Giordano Bruno burned at the stake in 1600 for daring to propose that it was real. The second truth has gotten far more people killed trying to state it publically than will ever be known.

But the truth must be told. The fact that the earth revolves around the sun was successfully suppressed by the church for over 200 years. It eventually caused a major upheaval in the church, government and thought. A realignment of social and traditional values. That was in the 1800's.

Now, about 400 years after the first truth was pronounced we must again face the shocking facts. The "horrible truth" the government has been hiding from us over 40 years. Unfortunately "the horrible truth" is far more horrible than the government ever imagined.

In its effort to protect democracy our government sold us to the aliens. And here is how it happened. But before I begin I'd like to offer a word in the defense

of those who bargained us away. They had the best of intentions.

Germany may have recovered a flying saucer in 1939. General James H. Doolittle went to Sweden in 1946 to investigate reports of 'ghost rockets' (UFO's) 1000 of which had been sighted over a 7 month period.

The "horrible truth" was known by only a very few persons: they were indeed ugly little creatures, shaped liked praying mantises and who were more advanced than us by perhaps a billion years. Of the original group that were the first to learn "the horrible truth" several committed suicide, the most prominent of which was Defense secretary James V. Forrestal who jumped to his death from a 16th story hospital window. Secy. Forrestal's medical records are sealed to this day.

President Truman quickly put a lid on the secret and turned the screws so tight that the general public still thinks that flying saucers are a joke. Have I ever got a surprise for them.

In 1947 President Truman established a group of 12 top military and scientific personnel of their time. They were known as MJ-12. Although the group exists today, none of the original members are still alive. The last one to die was Gordon Gray, former Secretary of the Army, in 1984. As each member passed away, the group itself appointed a new member to fill the position. There is

some speculation that the group known as MJ-12 expanded to at least several more members.

There were several more saucer crashes in the late 1940's, one in Roswell, New Mexico, one in Aztec, New Mexico and one near Laredo, Texas, about 30 miles inside the Mexican border.

Consider if you will the position of the United States government at that time. They proudly thought of themselves as the most powerful nation on earth having recently produced the atomic bomb, an achievement so stupendous that it would take Russia 4 years to catch up and only with the help traitors to democracy. They had built a jet aircraft that had exceeded the speed of sound in flight. They had built jet bombers with intercontinental range that could carry weapons of enormous destruction. The post war era had brought economic prosperity and the future seemed bright. Now imagine what it was like for those same leaders all of whom had witnessed the panic of Orson Welles radio broadcast of "The War of the Worlds" in 1938. Thousands of Americans panicked at a realistically presented invasion of earth of beings from another planet. Imagine their horror as they actually viewed the dead bodies of these frightening looking little creatures with enormous eyes, reptilian skin and claw like fingers. Imagine their shock as they attempted to determine how these strange 'saucers' were powered and could discover no part even remotely similar to components they were familiar with: no cylinders or pistons, no vacuum tubes or turbines,

The stories are legendary on transporting crashed saucers over long distances , moving only at night, purchasing complete farms, slashing through forests, blocking major highways, sometimes driving 2 and 3 lo-boys in tandem with an extraterrestrial load a hundred feet in diameter.

On April 25, 1964, the first official communication between these aliens and the U.S. Government took place at Holloman Air Force Base in New Mexico. 3 saucers landed at a pre-arranged area and a meeting was held between the aliens and intelligence officers of the U.S. Government.

During the late 60's or early 70's MJ-12 representing the U.S. Government made a deal with these creatures called EBE's (extra-terrestrial biological entities, named by Detley Bronk, original MJ-12 member and 6th president of Johns Hopkins University). The 'deal' was that in exchange for 'technology' that they would provide to us we agreed to 'ignore' the abductions that were going on and suppress information on the cattle mutilations. The EBE's assured MJ-12 that the abductions (usually lasting about 2 hours) were merely the ongoing monitoring of developing civilizations.

In fact, the purposes for the abductions turned out to be:

- (1) Insertion of a 3mm spherical device through the nasal cavity of the abductee into the brain. The device is used for the biological monitoring, tracking and control of the abductee.

- (2) Implementation of post hypnotic suggestion to carry out a specific activity during a specific time period, the actuation of which will occur within the next 2 to 5 years.
- (3) Termination of some people so that they could function as living sources for biological material and substances.
- (4) Termination of individuals who represent a threat to the continuation of their activity.
- (5) Effect genetic engineering experiments.
- (6) Impregnation of human females and early termination of pregnancies to secure the crossbred infant.

The U.S. Government was not initially aware of the far reaching consequences of their 'deal'. They were lead to believe that the abductions were essentially benign and since they figured the abductions would probably go on anyway whether or not they agreed, they merely insisted that a current list of abductees be submitted, on a periodic basis to MJ-12 and the National Security Council. Does this sound incredible? An actual list of abductees sent to the National Security Council? Read on, because I have news for you.

The EBE's have a genetic disorder in that their digestive system is atrophied and not functional. Some speculate that they were involved in some type of accident or nuclear war, or possibly on the back side of an evolutionary genetic curve. In order to sustain themselves they use an enzyme or hormonal secretion

obtained from the tissue that they extract from humans and animals. (Note: cows and humans are genetically similar. In the event of a national disaster cow hemoglobin can be used by humans.)

The secretions obtained are then mixed with hydrogen peroxide and applied on the skin by spreading or dipping parts of their bodies in the solution. The body absorbs the solution then excretes the waste back through the skin. The cattle mutilations that were prevalent throughout the period from 1973 to 1983 and publically noted through newspaper and magazine stories and included a documentary produced by Linda Howe for the Denver CBS affiliate KMGH-TV, were for the collection of these tissues by the aliens. The mutilations included genitals taken, rectums cored out to the colon, eyes, tongue and throat all surgically removed with extreme precision. In some cases the incisions were made by cutting between the cells, a process we are not yet capable of performing in the field. In many of the mutilations there was no blood found at all in the carcass, yet there was no vascular collapse of the internal organs. This has been also noted in the human mutilations, one of the first ones of which was Sgt. Jonathon P. Louette at the White Sands Missile Test Range in 1956 who was found three days after an Air Force Major had witnessed his abduction by a 'disk shaped' object at 0300 while on a search for missile debris downrange. His genitals had been removed, rectum cored out in a surgically precise 'plug' up to the colon, eyes removed and all blood removed with again, no vascular collapse. From some of the evidence it is apparent that this surgery is accomplished in

most cases while the victim, animal or human is still alive.

The various parts of the body are taken to various underground laboratories one of which is known to be near the small New Mexico town of Dulce. This jointly occupied (CIA-alien) facility has been described as enormous with huge tiled walls that 'go on forever'. Witnesses have reported huge vats filled with an amber liquid with parts of human bodies being stirred inside.

After the initial agreement, Groom Lake, one of this nation's most secret test centers, was closed for a period of about a year sometime between 1972 and 1974, and a huge underground facility constructed for and with the help of the EBE's. The bargained for technology was set in place but could only be operated by the EBE's themselves. Needless to say, the advanced technology could not be used against the EBE's themselves in case of need.

During the period between 1979 and 1983 it became increasingly obvious to MJ-12 that things were not going as planned. It became known that many more people (in the thousands) were being abducted than were listed on the official abduction lists. In addition it became obvious that some, not all, but some of the nations missing children had been used for secretions and other parts required by the aliens.

According to some, there was an altercation between the U.S. military and the aliens at the Dulce laboratory. A special armed forces unit was called in to try and free a number of our people trapped in the facility who had become aware of

what was really going on. According to one source 66 of the soldiers were killed in the effort and our people were not freed.

By 1983, MJ-12 must have been in stark terror at the mistake they had made in dealing with the EBE's. They had subtly influenced (through Dr. Hynek, formerly with the Blue Book project, who had allegedly broken ties with the Air Force in the late 60's but who in reality continued to be their informant in his cover capacity of Director of the Center for UFO Studies) "Close Encounters of the Third Kind" and "E.T." (now admitted by some members of MJ-12 to have been a 'drastic mistake') to get the public used to "odd looking" aliens that were compassionate, benevolent and very much our "space brothers". MJ-12 had, in effect, 'sold' the EBE's to the public, and were now faced with the fact that quite the opposite was true. In addition, a plan had been formulated in 1968 to make the public aware of the existence of aliens on earth over the next 20 years to be culminated with several documentaries to be released during the 1985-1987 period of time. These documentaries would explain the history and intentions of the EBE's. The discovery of the "Grand Deception" put the entire plans, hopes and dreams of MJ-12 into utter confusion and panic.

Meeting at the "Country Club", a remote lodge with private gold course, comfortable sleeping and working quarters and its own private airstrip built by and exclusively for the members of MJ-12, it was a factional fight of what to do now.

Part of MJ-12, which had now become military top-heavy, wanted to confess the whole scheme and shambles it had become to the public, beg their forgiveness and ask for their support. The other part (and majority) of MJ-12 argued that there was no way they could do that, that the situation was untenable and there was no use in exciting the public with the 'horrible truth' and that the best plan was to continue the development of a weapon or 'plan of containment' that could be used against the EBE's under the guise of "SDI" the so-called Strategic Defense Initiative which had nothing whatever to do with a defense for inbound Russian nuclear missiles. In fact, the real definition of purpose for SDI reads "The plotting, tracking and acquisition of articles in deep space." As these words are being written, Dr. Edward Teller, 'father' of the H-bomb is personally in the nuclear test tunnels of the Nevada Test Site, driving his workers and associates in the words of one, 'like a man possessed'. And well he should be for Dr. Teller is a member of MJ-12 along with Dr. Kissinger, Admiral Bobby Inman, General Lew Allen to name a few members of MJ-12.

Before the "Grand Deception" was discovered and according to a meticulous plan of metered release of information to the public, several documentaries and video tapes were made. William Moore, a Burbank, California based UFO researcher who wrote "The Roswell Incident" a book published in 1980 that detailed the crash, recovery and subsequent cover-up of a UFO with 4 alien bodies has a video tape of 2 newsmen interviewing a military officer associated with MJ-12. This military

officer answers questions relating to the history of MJ-12 and the cover-up, the recovery of a number of flying saucers and the existence of a live alien (one of 3 living aliens captured and designated or named EBE-1, EBE-2 and EBE-3 being held in a facility designated as YY-II at Los Alamos, New Mexico. The only other facility of this type, which is electromagnetically secure, is at Edwards Air Force Base in Mojave, California). The officer names names as previously mentioned plus a few others: Harold Brown, Richard Helms, Gen. Vernon Walters, JPL's Dr. Lew Allen and Dr. Theodore von Karman to name a few of the current and past members of MJ-12.

The officer also relates the fact that the EBE's claim to have created Christ. The EBE's have a type of recording device that has recorded all of earth's history and can display it in the form of a hologram. This hologram can be filmed but because of the way holograms work does not come out very clear on movie film or video tape. The crucifixion of Christ on the Mount of Olives has allegedly been put on film to show the public. The EBE's claim to have created Christ, which, in view of the "Grand Deception" could be an effort to disrupt traditional values for undetermined reasons.

Another video tape allegedly in existence is an interview with an EBE. Since EBE's communicate telepathically an Air Force colonel serves as an interpreter. Just before the recent stock market crash several newsmen including Bill Moore had been invited to Washington, D.C. to personally film the EBE in a similar type

interview and distribute the film to the public. Apparently, because of the market crash, it was felt the timing was not propitious. In any case it certainly seems like an odd method to inform the public of extraterrestrials, but it would be in keeping with the actions of a panicked organization who at this point in time didn't know which way to turn.

Moore is also in possession of more Aquarius documents a few pages of which leaked out several years ago and detailed the supersecret NSA project which had been denied by them until just recently. In a letter to Senator John Glenn NSA's Director of Policy Julia B. Wetzel wrote, "Apparently there is or was an Air Force project by that name (Aquarius) which dealt with UFO's. Coincidentally, there is also an NSA project by that name." NSA's project Aquarius deals specifically with the 'communications with aliens' (the EBE's). Within the Aquarius program was project 'Snowbird' a project to test fly a recovered alien aircraft at Groom Lake, Nevada. This project continues today at that location. In the words of an individual who works at Groom Lake 'our people are much better at taking things apart than they are at putting them back together'. Another saw a saucer being trucked into the Nevada Test Site in March of 1988. Still another informant witnessed a saucer being buried at that location (for God knows whatever reason) during the second week of August 1988.

If the government felt they were being forced to acknowledge the existence of aliens on earth because of the overwhelming evidence such as the Hudson Valley sightings during the past 4 years, the Wytheville, Va. sightings in October and November of 1987, the Gulf Breeze, Florida sightings in which documentary evidence in the form of stereoscopic photographs and video tape were taken between November of 1987 and May of 1988, the Lake Superior sightings of 1988 and the sightings in and around Las Vegas, Nevada and the Nevada Test Site, and taking into consideration the "Grand Deception" and obviously hostile intent of the EBE's it might be expedient for MJ-12 to admit to the EBE's but conceal the information on the mutilations and abductions of humans and animals.

The enormity of the problem must be driving more than a few 'at the top' to drink. But what about the rest of us? Most of those reporting sightings are being viciously ridiculed by government sponsored 'debunkers' such as Philip Klass, former Avionics editor for Aviation Week and Space Technology, NASA scientist James Oberger and a host of others. When the truth does emerge, if it ever does, how is this shabby, dishonest treatment of totally sane, normal and patriotic citizens going to be justified?

Now you ask, "Why haven't I heard about any of this?" Who do you think you would hear it from? Dan Rather? Tom Brokaw? Sam Donaldson? Wrong. These people just read the news. They don't find it. They have ladies that call and interview witnesses and verify statements on stories coming over the wire either

AP or UPI. It's not like Dan Rather would go down to Wytheville, Virginia and dig into why there were 4000 reports of sightings in October and November of 1987. Better that Tom Brokaw or someone else should risk their credibility on this type of story. Tom Brokaw? Tom wants Sam Donaldson to risk his credibility. No one...but no one is going to risk their reputation on such outlandish ideas regardless of how many people report sightings of 900 foot objects running them off the road. In the case of the Wytheville, Va. sightings, dozens of vans with NASA lettered on the side failed to interest newsmen. And those that asked questions were informed that NASA was doing a weather survey.

Well then you ask what about our scientists...what about Carl Sagan? Isaac Asimov? Arthur C. Clarke? Wouldn't they have known? If Carl Sagan knows, then he is committing a great fraud through the solicitation of memberships in the Planetary Society, 'to search for extraterrestrial intelligence'.

Another charade into which the U.S. Government dumps millions of dollars every year is the radiotelescope in Arecibo, Puerto Rico operated by Cornell University with, guess who, Carl Sagan. Cornell University is ostensibly searching for signals from outer space, a sign maybe, that somebody is out there. It's hard to believe that relatively intelligent astronomers like Sagan could be so stupid.

What about Isaac Asimov? Surely the most prolific science fiction writer of all time would have guessed by now that there must be an enormous cover-up.

One current hypothesis is that, from the available evidence, it appears that the EBE's are trying to regenerate their own species at our expense. They have apparently suffered either some kind of nuclear holocaust or they may be on the back side of a bell-shaped evolutionary curve where in essence they are 'devolving' instead of evolving. In any case, according to several autopsies of aliens that have leaked out, the EBE's have an atrophied digestive system and other physical problems. This would account for their attempts to cross-breed with us as outlined in 'Intruders' by Budd Hopkins (a detailed study of an Indianapolis woman who, over several years produces 7 cross-breed alien children none of whom she was allowed to keep. Not that she wanted to.)

Whatever the answer these facts are indisputable. The extent and number of persons reported missing every year is a closely guarded government secret. (Since 1980 at least 20,000 children have been reported missing each year.)

Cattle mutilations (over 14,000 since 1973) are regarded officially by the government as 'a hoax'. Human abductions are officially regarded by the government as a 'hoax'. The latest polls show that 88% of all Americans believe that intelligent life on other planets is probable and that over 20 million Americans have seen what they believed to be a UFO. But the U.S. Government officially dismisses 'flying saucers' as a 'hoax'. What do you think?

The best advice I can give you is next time you see a flying saucer and are awed by its obvious display of technology and gorgeous lights of pure color:

RUN LIKE HELL!



An Interview With John Lear

25 November 1989

> Welcome back. It has been a long absence.

L: It sure has.

> Your absence has the public wondering what happened.

L: Well, I was the host for the MUFON Conference in Las Vegas. There were about twelve speakers and we accomplished a lot. There was a lot of information given out. To my absolute surprise and shock I was called into the airline that I worked for, about five days after the conference. I met with senior airline officials and they asked me "You don't really believe all this stuff, do you?" "Well, yes sir I do", I said. "Why?" they asked. I gave them about a ten minute rundown on my research in the past three years and they said, "We just can't have anybody who believes this stuff flying for our company. What if our passengers found out?". I was summarily terminated. It was a great shock to me. I had many many years of seniority as a captain with this company. I had to get out and hussle for another job. With my qualifications, I didn't have much trouble finding another one...it was a while before I got my life sorted out. During that time I haven't had time to get involved, although I have been keeping abreast of the situation.

> I take it you were refusing any and all interviews during this period..

L: Yes, I was so busy getting into the new job..

> Did you feel like you've been burned by your belief, insofar as you went public and lost your job?

L: No. I just felt sorry for these people who have not kept abreast of the events and who really and sincerely believe that nothing is going on. I really felt sorry for them because they were so ignorant.

> One thing is absolutely clear. Something is going on. I would guess that you would say " They are Here"...

L: Yes. Beyond a shadow of a doubt. Since I last talked to you I have seen one. I was taken out to a desert test center by a theoretical physicist who worked directly for the Navy, and he told me , "We're going to fly tonight. Would you like to see it?". I went out into the desert and watched it fly. It was kind of interesting, although it wasn't a shock to me because I knew they were there. I said " So what else is new?"

> That would be Robert Lazar?

L: Yes. We kept his name Confidential for the year that we knew what he was doing. He came public here about a week ago on Channel 8's two-week UFO special.

> You worked closely with Robert Lazar for a period of time. How much of that story can you tell us?

L: Most all of it. There are some aspects of it that I cannot discuss to the public. You know what I am talking about.

> Yes

> Is that area called Area 51?

L: Well, let me explain that what is known as the Test Site is an enormous area that borders between Caliente, Tonopah and Las Vegas. The very center of it called Area 51. It's a 10 mile by 10 mile square which is called by various names. It's called Groom Lake, Watertown, The Area, The Spot...all kinds of different names....the Red Square and Dreamland are two more. A lot of secret testing goes on there. The U-2, the SR-71, and Aurora have been tested there.

> What about the Aurora?

L: Well, the Aurora is the follow-on for the SR-71. It cruises at Mach 10 and has a ceiling of 285,000 feet. It is a three man aircraft that was built by General Dynamics. It is methane powered and currently operates out of Groom Lake. There are a lot of other secret programs that go on up there. The area called S-4 is where the saucers are flown. It's approximately 10 miles southwest of Groom Lake. This is where they keep the nine extra-terrestrial saucers that the government works on under a Navy project. Let me tell you. There are a lot more saucers, but they are kept in various other areas. They are working on these specific disks in order to get some of the technology out of them. The technology is so far advanced that there is very little hope of us using any of it. The other saucers are kept at Wright Patterson AFB, Kirtland AFB, Homestead AFB....there are about five other bases that they're kept at. The last one that they recovered - the one that crashed in the desert in Botswana in May 1989 was taken to Wright Patterson in June and then it was transferred to Kirtland AFB sometime this year. It is now presently at Kirtland.

- > If a reporter wanted really convincing footage of a UFO, is there a place that he could go?
- L: Yes, they could go to the road to the east of Rachel, Nevada and shoot to the south. It's at sunset that they fly, and there's no problem. The problem is that they expect to get things in 15 minutes. Most of the reporters are young and are just getting into this stuff. They show the same films on television that they have been showing for the last 20 years. They often test on Wednesday nights at Groom Lake.
- > Are you familiar with the F-117A?
- L: Yes. The F-117A is the Stealth fighter. It has been operational since 1981. The first derivatives of the Stealth have been flown since 1978. It is flown out of the Tonopah Test Range, which is in the extreme northwest corner of the Test Site. It was tested at Groom Lake, but it doesn't fly much there anymore.
- > What would you see if you went up there?
- L: You would see the same thing I saw when I was invited up there March 22nd. In the distance, it looked like a dancing light. When I looked at it through a Celestron telescope it was definitely a disk. I saw it and others also saw it.
- > They have something up there.
- L: There's no doubt about it. Bob Lazar took a lie detector test and he was on Channel 8. He told people what the propulsion was about. It uses gravity amplifiers. When he took us out there one time the security forces caught us. It was legal for us to be on BLM land, but they have these storm troopers out there who work for the government. They come out and harass you. They know they can't legally kick you out of there but they can certainly make it uncomfortable for you. They made it uncomfortable for us - certainly for Bob Lazar. They terminated his job with EG&G the next day. When he showed up to work one of the security officers put a gun in his ear. It was an unpleasant experience, but that's the way the government operates.
- > One of the things that Channel 8 pointed out is that all of a sudden Bob had no school records or records of employment. They had all been erased.
- L: Yes. He has two degrees from MIT. He attended Pierce College and Caltech. He worked at Los Alamos on the SDI project. He is a very brilliant scientist.

> If he attended all these schools, what about diplomas?

L: They exist. I've seen them. The only news media that has a full copy of all his employment records and all his degrees is the Review Journal in Las Vegas, and they called Los Alamos and recieved all that information Fedex in May 1989.

> What happens to Robert Lazar now? He's virtually a non-being.

L: He has his own business locally in which he works every day.

> One time you stated that we have the alien technology and that we have the ability to study it in some way. How does that jibe with the fact that we appear to be flying these things? We are obviously mastering some of their technology to be able to go that far.

L: Well, we can fly it but we can't build it. It's as if you took an SR-71 and dropped it into a WWI air base. There are some things that we have built with the technology that we have attained, but these are airplanes that the public has never seen and probably will never see.

> Much of the media suggests that the aliens are warm, fuzzy ETs that are benevolent. It ocured to me that since they are here and they haven't gone public, that they could just as easily be bad guys as good guys.

L: That's certainly what I believe. If they were good guys, don't you think that the government would want to release information about them after 40 years of contact? Would they tell us why they haven't cured cancer, etc? If this is going on then the government would want to take advantage and claim credit for advances in science and medicine, but this doesn't seem to be the case. It is apparent to me that this particular group of aliens that the government made arrangements with are not a good group of people. We are being visited by approximately 70 different races. The government, in 1963, was aware of 17 species according to the Grudge 13 report. Since then, there have been other species discovered. The ones that the government made the deal with in the late 1960's, the ones known as the Greys, are the oncs that are giving us a problem.

- > What are some of the main types of species that are here?
- L: The trade for technology was made with Grey skinned beings about 4 feet tall with oversized heads. They have the almond shaped eyes. They have the arms that come down below their knees. They have four fingers. Two are longer than the others and they're partially webbed. They have claws on the end. That's one type. There's another type that's about the same height with a more roundish type head and roundish eyes. These are the ones that are supposedly from Zeta Reticuli. We have ones that look like humans. There are all kinds of different ones. I have no doubt that some of those are friendly, but the ones we have the problem with is the Greys.
- > If some of these aliens are bad and wish us ill will, then you could almost understand why the government must be in a desperate search to try and understand and duplicate their technology so that we could defend ourselves. Does that make sense?
- L: That makes sense, and that's exactly what's going on. You have to understand that this is the biggest and most important secret in the history of mankind. The people that are involved in these programs have to sign a security oath and also a piece of paper saying that they agree to give up their Constitutional Rights to a fair trial if they get into the program. That means if they divulge information they can be killed or committed for the rest of their lives to a mental institution.
- > How does that bear on what Robert Lazar has done going public?
- L: Well, it's only been a week since he made his statements. We're waiting to see what happens.
- > Do you think that some guys in black suits are going to walk in and...
- L: I don't know. His friends are worried about him. That's where it stands.
- > I bought the book "Alien Harvest" by Linda Howe, and its an excellent book that I would recommend to anyone.
- L: I would too. I spent a lot of time researching with Linda Howe and drove through Colorado, Arizona and New Mexico with her on some of my research. She's a very knowledgeable lady.

> You mentioned that she had information relating the Kennedy assassination and UFOs, and I wonder if you could shed some light on that. She really didn't cover it in the book.

L: Well, to digress a moment, there were two times that the Government was going to tell the people about the existence of flying saucers and aliens. The first time was in 1972 when MJ-12 contacted Grey Advertising in Los Angeles and had them write a documentary which was called "UFOs are Real". Robert Emmanegger was the man who wrote it, and he was taken to Norton AFB and shown still photos of the original film of the landing at Holloman AFB in New Mexico which occurred on April 25, 1964. This documentary was narrated by Rod Serling. It was essentially a whole history of UFOS, and at the end of the documentary they were going to have the actual footage of the saucer landing and the aliens getting out. What happened was Watergate. The powers to be decided that the public could not handle two traumatic experiences at one time, so they cancelled the release to the public. They did, however, release the documentary. At the end they replaced the motion picture footage of the actual event with drawings. Rod Serling says, "let's consider an event that may happen in the future or already may have happened". Of course it had happened.

The second time the government was going to let the public know some of what was going on was in 1983 when they contacted Linda Howe. Linda Howe was the go-between between MJ-12 and Home Box Office (HBO). She was to have access to 68,000 feet of motion picture film of disks, landings, etc. She was also to meet one of the aliens, designated EBE-II, who was kept at Los Alamos National Laboratories in New Mexico.

I have since talked with a scientist who worked there and who verified that it was approved for her to meet the alien. For some reason, all of this did not come off and the project was cancelled. During the time that Linda Howe functioned as the go-between between MJ-12 and HBO she was told, in more or less an effort to let her know how serious this was, that the powers to be had to eliminate President Kennedy because he wanted to release the information on the disks and the aliens in 1963. Since then, we have talked to people who have heard the recording made in the Oval Office when Kennedy pounded his fist and told the representatives of MJ-12, "you guys better get your stuff together because I'm going to tell the public".

- > There are people who would suggest that this is just why he was assassinated.
- L: There were several reasons why he was assassinated. One was the Bay of Pigs fiasco, another was that he had threatened to "shatter the CIA into a thousand pieces". A third reason was because he threatened to pull our all Americans from Vietnam by 1965. The fourth was that he intended to expose the alien-disk coverup.
- > A lot of people may not understand what MJ-12 is.
- L: MJ-12 was a group of top military and scientists formed by President Truman by Executive Order on September 24, 1947, approximately two months after they recovered the first disk near Roswell, New Mexico. Their job was to report to the President on the technology and maintain the coverup. The group has been in control of every major decision in the United States since that time.
- > Why has it been so long since a major incident like Roswell has come into the public eye?
- L: It shows the extent and effort put into the coverup. They've done one hell of a job.
- > How far have we flown the craft that we have?
- L: I don't know for a fact. I assume from what I have heard that we have gone to the Moon and several of the planets. I say that because a friend of mine has seen photos taken on Mars which indicate that there are cities, with buildings, doors and windows.
- > Recently there was a reported sighting in the Soviet Union where several entities approximately nine feet tall emerged from a spacecraft. Where do these people fit into your catalogue of fuzzy people? Who in the government appoints MJ-12 successors? If Mr. Lazar is committed by the Government for telling what he knew, are the psychologists there sworn to secrecy too?
- L: I am sure the Soviet sighting is credible. I have personally never heard of entities that are nine feet tall, although that does not mean they don't exist. The last questions demonstrate some little knowledge of how the government works. MJ-12 appoints their successors. All of the original MJ-12 are dead. The last to die was Gordon Grey around 1983. We don't know all the names of the current MJ group. I can give you some names of people who are heavily involved in the coverup. One is Edward Teller, the so-called 'father of the H-bomb', who hired Robert Lazar to work at the test site. Doctor Teller is in charge of the disk program up at the Test Site.

- > He's also the father of the Star Wars program. How does that fit into all of this? Brilliant Pebble.
- L: I don't know anything about Star Wars except that it does what it was designed to do but was finished in 1984. All the money that is being appropriated for Star Wars at this moment is being diverted to other programs including the programs at S-4.
- > If that's so, it points to the desperate nature of the work going on at Area 51.
- L: That's right. In answer to the last question about Robert Lazar if he was committed, the people who would do that would not employ people who would reveal the information. One of the persons who they have committed for a short time is Paul Bennewitz. We all know that he was the father of exposing all this stuff in 1979. He ran Thunder Scientific Corporation, who made temperature monitoring equipment for the Air Force. He lives in Albuquerque, New Mexico. His house faced towards the Manzano Weapons Storage Area. He was the first one to get pictures of disks taking off and landing there at Kirtland AFB. He took these photos down to Kirtland and said something like , "hey you guys, look at what's going on!". They were so shocked that it took them about six years to get him in an asylum. He has not done much since he emerged from there.
- > If Robert Lazar has worked with this disks and he has signed a Security Agreement, as well as made the information. If they come to him in any way at all right now, won't they just lend credence to his story?
- L: That's what we would think. That's what we're hoping - that he'll be safe by making these statements. It will be interesting to see what will be happening in the next few weeks with Bob.
- > Do you know if S-4 pumps out any frequencies that we can listen to?
- L: All communications there are done on VHF and UHF. If you go up there with a frequency counter and a scanner, you can find out what frequencies they're transmitting on. The guards, up until last friday, transmitted on 138.3 but when they changed it when they found out that it was public knowledge. If you go up there and monitor UHF, you can actually hear them talking from the ground to the disks at 220 Megacycles.
- > Have you seen an alien?
- L: No Sir, I have not.
- > Have you seen a disk?
- L: Yes, I did see the one that the government flew on March 22nd, and that's the only one I've ever seen.

- > How big was it?
- L: Well, it was about three miles from where we were standing to the Groom Lake area. I'm not very good at sizes, but I would imagine that it had a diameter of from 30 to 50 feet.
- > Is Tesla's technology involved in this?
- L: I'm sure it is, but like I said, I'm just an airplane pilot and I don't know about that stuff.
- > What can you say about Forrestal?
- L: Forrestal was the Secretary of Defense. He was one of the original MJ-12 team put together by President Truman. They say he committed suicide in 1950 but that was not the case. In fact, he was thrown out the hospital window with his arms tied behind his back.
- > Who did it?
- L: Your guess is as good as mine.
- > Can humanity handle all this? Wouldn't religion and the economy be disrupted?
- L: It probably would, and that's probably why it's a secret. Everybody that I have talked to about this...when they realize that this information may be true, their first question is, "well what about God?". After the George Knapp special and the Lazar thing, I haven't heard of any suicides around Las Vegas.
- > On November 24th, NASA announced plans to have a manned mission to the moon for 30 days in the year 2001, and to establish a nuclear powered base on the moon as a stepping stone to a Mars flight. Comment?
- L: I hate to disappoint you, but most of us are not going to make it to the year 2001.
- > Why?
- L: If you listen to the tape made by Dr Strecker on AIDS, which was created by the government, seventy-five percent of the earth's population will be dead by 1996. They are going to try to keep the earth's population at 25%. Look at the tape. It will tell you how and when the AIDS virus was made. Contact the Strecker Institute in Los Angeles for more information. The government will stop the virus when the population reaches 25 percent.

- > How do you reconcile flying saucers and the idea of God?
- L: Well if UFOs are real, either God had something to do with it or He didn't. If God have something to do with it, who built the flying saucers? If God didn't have anything to do with it, who built the flying saucers? I know more about this, but it may be something the public should not know at this time.
- > Do you mean we're not ready to know it?
- L: No, I don't think so. It would be very frightening to most people, to say the least. The public has a hard time grasping the idea of flying saucers - how are they going to grasp the absolute truth. People can only absorb so much at one time.
- > I was stationed at Kirtland AFB in Albuquerque, New Mexico?
- L: What year, sir?
- > Between 1951 and 1953
- L: Those were very interesting years.
- > I had a minor administrative position, but I was stationed with a unit that was dealing with flying saucers while I was there. My position didn't allow me too much exposure, but my best friend who was stationed with me was involved. The thing I wanted to tell you was that I talked to a Tech Sergeant that was involved in the B-29 atomic program there. He told me that during the second world war he saw a flying saucer disassembled at Norton AFB, and he was subsequently transferred to Aniwetok Island in the Pacific after it was discovered that he knew about it.
- L: Norton AFB was a very important facility. It was the repository of most of the motion picture film that the government has on UFOs and there were a number of disks kept there.
- > The organization that I was with had thousands of feet of film that showed different kinds of flying objects.
- L: That's very interesting. 1952 was a very interesting year. They flew over the White House during a two week period in that year.
- > I have gotten ahold of a copy of the book called MATRIX. How much of that do you believe is true?
- L: There's a lot of very interesting information in that book. A great deal of it came right off my desk. If you could ask me about a specific document?

> How about the Krill Papers?

L: The Krill Papers were written by the same person who wrote the MATRIX, and both he and I have done a tremendous amount of research, and he just used the name Krill because he works in a very sensitive position and didn't want his name known. Those are basically his ideas.

> With the MATRIX and some of the other books I have been reading I think that its pretty scary and that some of it should be kept under wraps. I don't think that the general public is ready for what I have been reading, anyway.

L: Well, I agree with you there.

> This keeps coming back like a bad dream. There is something so dire and scary that the public can't know. Is there a time in the future when you can tell it all?

L: I don't think we have much time for people to understand what's going on. People should enjoy their life. The whole program of the extraterrestrials was to Organize and Pacify. Remember those two words. There is so much going on that there is no way to bring everyone up to speed.

> Is there more to the abductions than people report? What kind of trouble are we having with the Greys? Are they good or bad?

L: The ones that the government is dealing with are the bads guys. There are good ones here, but apparently they aren't directly a part of what's going on. If the ones were dealing with are good, why did they murder 44 scientists and 66 military members at one of the bases? I know someone who read that document; a document that discussed that particular incident, which happened in 1979.

> I presume this has been covered up.

L: Certainly. I know one of the families of one of the people that was killed - Dr Gary Henderson, who testified before Congress. He worked for General Dynamics, and in 1979 he disappeared off the face of the earth. He was involved in that division of General Dynamics which deals with UFOs. We looked for him and found out that he had been attached to a Top Secret detachment that was stationed up at the Test Site. He was one of those 44 scientists. The government has a way of going to families and giving them money to "help them over their problems".

> Isn't the Government murdering people by introducing AIDS into the general population?

L: Well, yes sir.

- > We can't do anything about this?
- L: No sir.
- > Will the earth be taken over by the aliens?
- L: I don't know. One of the problems in this research is that I wish I had all the answers. All I'm telling you is what I know to be true. I will also tell you when I am speculating. As far as the AIDS things is concerned, I know that to be true.
- > There's nothing we can do about it? We just sit back and die at their leisure?
- L: Yes. It wouldn't even remotely occur to people that people as high as the Joint Chiefs of Staff were involved in the murder of Kennedy - how are they going to understand the AIDS problem?
- > I want proof . If we're all doomed because of AIDS, there has to be way to reveal this, and once revealed, begin to do something about it. You have to take steps. You say they have a way to cure it.
- L: Yes
- > Then there has to be a way to bring pressure to bear so they will bring out the cure before Genocide occurs.
- L: It's not in the plan. The overall plan is to get rid of 75% of us. You can't go against the plan. That's what we have to put up with.
- > Is there any approach to change this?
- L: You can tell people, but they are not going to believe you. They don't even believe in flying saucers. How are they going to believe that?
- > It would seem like people with such advanced knowledge as some of these aliens would be benign in nature. Apparently, I'm wrong.
- L: Yes, sir you certainly are wrong. As far as interchange between species is concerned, do you go out and talk to cows and try and relate with them and teach them mathematics, or do you just use them for food?
- > Well, I don't go out and talk to them, and I don't use them for food - that much.
- L: What if I were to tell you that the planet Earth was just a farm.

> Ok, I can see that. Have they been doing genetic experiments with humans?

L: Well, yes. In fact, we are just one big genetic experiment. You don't seriously believe that we came from the fish in the sea and just evolved in 15 billion years to what we are now. The chances of that happening are 20 quadrillion to 1. It just couldn't happen.

> Astronomers have recently located an object in space...a pulsar.. which they believe is hundreds of billions of years old. The discovery of this pulsar throws a monkey wrench into every theory of evolution.

L: It certainly does. I can't help wonder if they're trying to get around to tell us the truth, but I doubt it, knowing what the truth is.

> How does the Secret Government stay in control and keep a lot of the wealthy people from knowing what's going on?

L: It's a complicated question. The 13 major banks, the Rockefellers and Rothchilds - they know what's happening. The Council for Foreign Relations knows. How do they keep the flying saucer thing secret? They do it with drugs and hypnosis. It's very very sophisticated. It was developed starting in 1955. They do it by first drugging the person who is brought into the program in combination with hypnosis. They structure it so that when a person works in the project, he's totally knowledgeable and conversant, but when he leaves, the memory leaves with him. The main reason that we found out what was happening to Bob Lazar was that we were probing using regressive hypnosis. He could remember going up there and coming back but he couldn't remember some of the things that went on up there. He has very clear memories that were not affected by the hypnosis and the drugs of looking inside the disk at S-4, of seeing it fly, of working with the technology. There are a lot of other things that he was privy to that didn't come out until we did the regressive hypnosis.

> We have live aliens up at Area 51?

L: Beyond the shadow of a doubt.

- > If they are not necessarily friendly, and we are trying to discern what their technology is about as we fly their craft around....have we put the thumbscrews to these guys...have we even tried to communicate with them?
- L: We can communicate with them. We've had three over the years... EBE1, EBE2 and EBE3. They were named by Doctor Detlev Bronk, who was on the original MJ-12 team. EBE stands for Extraterrestrial Biological Entity. We've learned that they recovered one more live alien from the Kalahari desert in South Africa in May 1989. I have a five-page report from the South African Air Force that someone managed to steal from that country. They sent two C-5A's to South Africa to pick up the debris, and the one live alien. Both C-5A's operate out of Wright Patterson. One has a controlled environment built inside the airplane. They can change the air to accomodate the aliens. The other C-5A is equipped to transport the disks.
- > Are you in a position to release any of the South African information?
- L: Its out there. Its been in the Nevada Aerial Research report.
- > Have you seen Barbara Honnegger's book , "October Surprise"? Do you agree with that?
- L: I not only agree with her..I sent her some of the information I has when I was flying in Cairo that supports what she's saying. It's beyond a shadow of a doubt that in October of 1980 the Reagan political group, before they were elected, cut a deal with Komeini in Iran to delay the release of the hostages for 76 days in return for the arms shipments. The reason I know that is I was part of the shipments in 1980 and 81.
- > They sabotaged the helicopters that were sent in to 'rescue' the hostages, too, didn't they?
- L: They certainly did, but that's only part of it.
- > If there was even the tiniest shred of proof, wouldn't the Democrats have used that to win the election?
- L: Well, there are certain reasons why they can't do that. Some of them were part of it. I was there , and I was part of the arms shipments, other than running the guns themselves, so I know that it happened.

- > You said that 75% of the population is scheduled to be eliminated by 1996. Is that by an AIDS virus contrived by our government?
- L: Yes. Our government created the AIDS virus. It was introduced by the World Health Organization into Africa in 1972. The public is being told that there are 20,000 cases a year when in fact there are 5,000,000, and in fact that doubles every year, so by 1996 it will have reached 75% of the world's population.
- > Was this WHO thing part of a vaccination program?
- L: Part of the final vaccination series which eradicated smallpox also introduced the AIDS virus.
- > Could you elaborate about the face picture on Mars? You said at one point that there were buildings up there?
- L: Yes. I get my information from Dr. Brandenburg, who has been involved in the research that covers that area on Mars. He was initially hired by NASA to research that area. They terminated the research for some reason and he went on with a group that did it on their own. Its called the Mars Research Project. He gave a paper at the MUFON convention in July which was very very interesting. What he says is that it is clearly evident that those are not natural formations, that indeed they were formed by some intelligent group, and in fact that the city that lies to the southwest about 10 or 15 miles is and was a city for some kind of race that lived on Mars. He has quite a bit of documentation to prove it, and on my own end, I have somebody who actually saw some pictures that the government keeps secret that clearly shows that it is, in fact, a city.
- > If the Star Wars program was finished in 1984, and they are still allocating money for it, why doesn't someone tell them?
- L: You have to understand that there are two realities here. The reality of what's really going on as far as the planet Earth is concerned, and there's the reality that you are involved in, where you believe in Congress and you believe that they run the United States, and you believe in the branches of government and that they make the laws, etc.
- > What you're saying probably explains their behavior than anything else.

- > You mentioned a couple of books one time that were important. What were they?
- L: One is called Majestic, by Whiteley Strieber. The other was the MATRIX, which is no longer for sale. I don't think there are any copies in existence other than the ones that were first published. Another book is "On the Trail of the Assassins" by Jim Garrison, about the Kennedy assassination.
- > Is it possible that the aliens only see us as a source of food? Are there tanks with body parts at Groom Lake?
- L: The tanks are not at Groom Lake. They are at other underground bases, one of which is near Dulce, New Mexico. It is possible that some of the aliens see us as a source of food, but I don't think that is the whole story.
- > Are you hesitant to talk about this aspect?
- L: Yes
- > Is it true that you are castigated by most of the so-called rank and file UFO researchers because of your statements about the negative nature of the aliens?
- L: They don't like what I have to say. The rank and file of the researchers, MUFON and the like, they like to go out and drink a cup of tea and talk about UFOs, but they really don't want to know what's going on.
- > As I understand it, there is speed more than the speed of light. Can you comment on this? A second question would be whether the aliens can target whom they wish?
- L: Yes, you can travel hundreds of thousands faster than the speed of light without breaking the basic laws of physics. Bob Lazar could explain it perfectly. It basically involves the folding of time and space. On the disk, or at least the one Bob was working on, they have gravity amplifiers. They pull one side of the universe closer, and then they turn it off and you're there. It's a difficult concept for most people to grasp. As far as aliens targeting a certain individual, we have evidence that they can and do. There is supposedly this thing where they have to have your permission to invade your privacy and most people apparently willingly give it.
- > How much do Congressmen and Senators know about this stuff?
- L: Congress knows relatively nothing.

- > How about the President?
- L: Our current President knows more than the rest because he was director of Central Intelligence in 1976. He was also involved in the Agency as early as 1960, so he has a little bit better input than Carter or Reagan. Carter couldn't fulfill his promise to make UFO information known. Reagan has mentioned "what if we were attacked by alien species from outside the planet..wouldn't it get us all together" five times in different speeches.
- > Are all the governments included in this problem ?
- L: The Soviets know a little bit. They were invited to S-4 to learn a little, as Bob Lazar has said. For some reason, they were kicked off the program. He doesn't know why. Gorbachev has said the same thing in his speeches about the threat from space.
- > What about the idea that the government is trying to disarm us?
- L: My personal opinion, if I were a cynic, would be that they are in fact trying to disarm the public, so that when they make their final move that there will be no resistance.
- > I have heard that there is film that distinctly shows a mining process going on on the other side of the moon. What do you know about that?
- L: That's for sure. I know a person in Houston who flew one of my dad's airplanes. He was shown by a NASA photographer one of the frames taken by Frank Borman on the back side of the moon on Apollo 8 of the mining equipment. The way he described it is that it was about three hundred feet long and it was shaped like a 'T'. It appeared like it was kicking up dust, like it was moving when the shot was taken.
- > Who do you think would be involved in the mining?
- L: I don't know.
- > Presumably either the government or some aliens or a consortium?
- L: Possibly.

> To be told that there is this massive threat and then to be told that we virtually can do nothing about it absolutely wears on me.

L: Well, come up with a suggestion. What would you like to do about it? Where would we start?

> I don't know.

L: In order to solve a problem, you have to understand the problem. If you can understand that our government was usurped and taken over by this small group of individuals, starting in the early 1960's....once you believe that we can get going. The problem is that most people still believe in their government...still believe that Congress makes the decisions and the President runs the country. As long as they believe that there is nothing we can do.

> Until they accept everything, they can't start down the road to recovery?

L: ~~That's right, and I don't believe there's any way you're going~~ to get the majority of the people to accept it. They're too busy watching 'Wheel of Fortune' and being Organized and Pacified.

> Why do you continue to expose yourself, despite the fact that you lost a job and open yourself up to ridicule?

L: I wish I had the answer to that question. I really do. I'm not on a crusade. It's certainly nothing I wish to continue.

> Could you elaborate on the 44 scientists that you say were killed by the aliens?

L: Yes. It was a story that came to me from two sources about two years ago. It was confirmed by someone who read a document up at the Test Site. Apparently in the late 1960's we made a deal with whoever it was that we would receive highly advanced technology in return for covering up the existence of the aliens and what they were doing. We thought that we would get advanced weaponry that we could use against our enemies, but in fact it turned out that we did get a lot of technology that was non-weapon oriented. These scientists were working at a highly classified facility, and in 1979 they collectively came upon information which indicated that something really really bad was going on. What it was, specifically, I do not know. Maybe they found out about the AIDS plan. It became necessary for the aliens to eliminate these 44 scientists. Whatever it was that happened, 66 Delta troops were sent in and ended up being killed along with the scientists. The document my friend read was dated 1981, and that's all I know.

> I've been told that 35% of the people in Africa are infected with AIDS.

L: It's more like 100%. That's where it started. Africa's gone.

> Were we in essence hoodwinked?

L: I believe that to be true. Yes.

> So, we are stumbling around up at Area 51 trying to get something useful from the saucers. Do you have any information as to whether we've actually realized anything of any use at all yet?

L: No, because it's too far advanced. It's maybe 100,000 to 500,000 years in advance of our technology. Bob Lazar talked about the fuel, which is Element 115. Our periodic table of elements only goes up to 103, and we can only produce that element for micro-seconds using enormous amounts of power. For us to even think of making Element 115 is absolutely impossible.

> What is element 115?

L: This is what fuels the basic power source. It drives an anti-matter reactor, which drives the gravity amplifiers, which supplies the propulsion. We can't even figure out how it can possibly be made, but there it is. We have 500 pounds of it.

> These aliens are using our planet. How does that relate to the universal mind?

L: You're pretty close to what Paul Davies, a brilliant British physicist said. He said: " a major assumption which goes into discussions of space colonization and interstellar communication is that biological intelligence in societies represent the supreme example of organization and complexity of matter. We have to face the fact that we may only belong to a transient stratum in a whole hierarchy of levels in organization and development." What about cows? Don't we raise them and keep them happy just to eat? Why would we think that we would be any different for a higher level?

> Because so much of what you say probably scares the hell out of people, and then when you say that you can't reveal the rest of the information, try to get us to understand why.

L: Well, all you're talking about revealing is really the ultimate of what is going on, and there's no reason to do that because most of the people don't even believe the beginnings of it.

> It is somehow tied to religion, isn't it?

L: Absolutely.

> You say it is the ultimate. Is it because you feel that the public wouldn't understand it? Because you feel it wouldn't do any good? That it would just stir up trouble?

L: It's just too incredible. If I blurted it out now and told you what I feel to be truth, it would be ridiculous. You'd say, "Oh, well that can't possibly be, because of this and that".

> In other words, you feel that the truth is so far out of sight that people would discredit everything you would say.

L: That's basically it.

> I appreciate the explanation.

> How can people protect themselves if the aliens decide to take them?

L: There's no way to protect yourself.

> Can we pray?

L: I don't think that would do very much good.

> You've said that some of these beings are evil.

L: Well, what is evil? Is it evil that we raise cows to eat?

> Is there a forum somewhere in which you could reveal the information that you cannot now reveal?

L: I doubt it. Things are happening so fast. I'm not involved in this any more.

> In other words, it's such a done deal that there's absolutely no point in revealing, pursuing it or anything else because there is nothing that can be done?

L: I would say that that is an accurate statement.

> Damn.

> Can you tell me about some of the alien races? Could we look to some of the good ones for help? If this is as bad as it seems, it seems to me that our race and the governments that lead us would think about destroying the world before they would let us be food for somebody else.

L: There are at least 70 alien races that we know of. There are millions more. Carl Sagan, when he was part of a Presidential panel, estimated that there are at least 1 million races similar to ours in the universe.

Why can't the good ones help us? We made our deal with the bad ones, and apparently there is some kind of agreement of non-interference. In other words, we control our own destiny, and we can't make a deal and then say, "oh, we made a mistake, can you help us out?". Apparently, that doesn't work.

Would the government consider blowing up the earth to keep us all from dying? All I'm going to tell you is that I'm laughing inwardly because I know something you don't and I'm not going to tell you about it.

> This must be very frustrating for you.

L: I got to the point where I knew what was happening and I thought, "what should I do? Should I try and tell people?" So I tried to tell them for a while, and it doesn't work.

> To be in that 25% that will survive, do you believe that if we don't have sex or only have safe sex that we will survive?

L: Absolutely not. It has nothing to do with sex or venereal disease.

> Some will be spared and others will not?

L: That's exactly right.

> Are you considering any personal survival plan?

L: No, all I'm doing is spending time with my family and just enjoying life.

> Are you the only one who knows the truth?

L: Well, all the people involved in the coverup know. There must be at least 100,000 people in the government. You have the secret government police force, which is the Defense Security system...there are probably 10,000 people in that group, which was originally for defense security....believe me they do a lot more.

> I have a couple things to say, and tell me if I'm wrong. The being that we know as Christ is an alien. The star that we celebrate at Christmas was a space ship. The Earth is already on a self-destruct mission with that Jupiter probe. The trip to the moon in 2001 that NASA was talking about will be for the survivors of this planet.

L: Some of those comments are correct. Some of them I won't comment on.

> I guess everyone will have to deal with what you've said and deal with it in their own way.

L: Right.

NOTES

Dear Editor,

I feel that John Lear should tell all he knows or not say anything at all. I perceive the tone of his delivery of information to be mocking and condescending. He claims to know the "ultimate secrets", yet won't share them and just invites people to feel that they are doomed and helpless. Let us be the judge of what we can or cannot believe, and process information as we see fit. I feel it is irresponsible to bait people and not follow through. What could be more shocking than what he has already revealed in his manuscript a year ago, or what Bill Cooper is releasing? Lear tells people that they'd better wake up, yet I don't perceive that his presentation is clear, organized, complete, or substantiated. I say, "put up or shut up", as many other researchers also do, I would appreciate a reply. Feel free to print my comments.

J.C., Pacifica, California

Dear J.C.,

There are two major aspects which would fit into a reply to this. The first one is that Mr. Lear has stated, in effect, that the disparity between what the public perceives as reality and what is really going on is so vast that in knowing it, they might quickly dismiss other data that they could use to begin their own investigation. People have to do things the way they do it, and many people have stated that they wished to know more about what is really going on. That's why Nevada Aerial Research and other organizations and individuals are releasing the information as it becomes apparent. There is not enough time in a typical lecture session to explain the complete depth of what is happening, and Mr. Lear is essentially saying, "take this, work together and look into these things and see what you can unearth together". The lecture that John Lear gives is a good basic point from which to begin additional research.

The second aspect of the reply is more holistic. In making a judgement, you become what you judge. How many have you served, and how well? Many people are content to sit in their armchair and pass judgement on the efforts of others. Everyone who has been involved in these scenarios has done a small part to induce an opening of awareness in the general public.

I can tell you that despite many elements around that appear negative, the progression of events is appropriate for each party involved, and eventually there will be a resolution that will be of an evolving nature. This is not to say, "don't worry, be happy" for that involves a state of relative unawareness and complacency, and is basically not appropriate for those who wish to evolve. The scenarios around us at this moment involve forces that have not achieved certain understandings that will eventually enable them to transcend dualistic squabbles. The time is not far off. The basic thing that we are trying to teach people is that their existence is permanent, whether in or out of a body, and that they have tremendous potential. Let's work on those blocks.

Update on Current Events
A Public Briefing
given by John Lear
May 14, 1990
Las Vegas

What I'm going to do today is just bring you up to date on some of the stuff that I know that's going on. Obviously, if you came here today, you know that what they call the "phenomenon" is real - it's going on. It's very frightening. I don't have to convince anybody here about what's going on, so instead of going through the usual background of all of this I'll just start off with a list of what's been happening in the last six months - the stuff that I know that's going on.

To start with, I'd like to start with the issue of missing children. If anyone was at the Bud Hopkins talk at the Spring Valley Library, you will remember that Bud has always made a point of saying:

"My field is abductions, that's all I do, I don't get into any of the other research, I'm not qualified on it, I haven't done the research and so I just stick with abductions. By the way, the Meier case was a fraud, the Adamski case was a fraud, there's no missing children and Bob Lazar is a fraud."

Bud's a nice guy but he speaks of things that he doesn't know anything about. The Adamski case was true. I know it because I talked with the CIA guy that went down to interview him. He was down there for a couple of days and they told him enough that there's no doubt that Adamski had all the experiences that he talked about.

As far as the Meier case, when I first got into what they call "UFology" I was told that the Meier case was a fraud, the pictures were faked, etc. I really believed that, and on one of the first George Knapp interviews that I did I said that the Meier case was a fraud. After about a year, I started checking around to make sure I was on firm ground. I called all the guys I knew in the field and asked them what their best evidence was that Meier was a fraud. They would say things like, "Oh, uh somebody else said that". Then you trace it further and no one seemed to know who was the one that started it. There was a lot of talk that the photos were hoaxed and that he had models in his garage....the bottom line is that there was no evidence that it was a fraud. In fact, Lazar worked on a machine identical to one of the craft in the Meier photos.

As far as Lazar is concerned, Hopkins said "don't believe what government scientists tell you". I have been involved in the Lazar case for about two years and there's no question in my mind that everything he says happened up there actually happened. There are a number of things that happened to him that that we're not telling the public, and with good reason. First of all, they wouldn't believe it, and secondly it would not really add that much more to the case. Bud was on a little shaky ground there. As far as the missing children

issue is concerned Hopkins, in order to prove his case, looked around the audience at the Spring Valley Library (about 250 people) and asked "does anybody here know of a missing child?". Of course, no one raised their hand and he said, "I rest my case". That's patently ridiculous. There are quite a number of missing children. There's an interesting book out called "A Good Night's Story". I heard about it from Bob Oechsler, head of the MUFON section in Maryland, and the story is printed like a childrens book and it's about children being abducted. Copies are going into every library and school. It has nothing to do with aliens or anything, but if child abductions is not a big problem, why the wide distribution of the book? There is a telephone number that you can call to order the book, 1-800-444-BLUE. I don't know what's behind it.

I'd like to talk a little about Dulce. The question is "is this true, does Dulce exist?" I like to have four independent confirmations about whatever I look into. The forth confirmation came in several months ago from an aerospace engineer who worked for the Air Force, mainly in designing aircraft and rockets. He was deeply involved in the Space Shuttle program. He said "yes, that in fact he had been at Dulce, that it exists". He visited the facility for something other than genetic engineering. The name that he knew it by was "Section B". So Dulce does exist. About six months ago, Gabe Valdez' brother found some of the aboveground ventilation shafts for the base on the top of Mount Archeleta. There were going to wait until the snow clears, which is just about now, before attempting to investigate further. I understand that the ducts were rectangular, horizontal, and about 30 feet wide. One of the guys that worked on the Meier video did some very sophisticated frequency analysis of the area and he said "whatever is under there puts out energy of a city the size of New York". There's just all kinds of stuff going on under there. That's the update on Dulce.

As far as the Greys are concerned, there are all types of Greys. They are definitely cybernetic organisms. They are not a "species" themselves. They work for someone else. There are several different levels of them. There are many instances that indicate that they don't function independently by themselves. They operate from higher orders.

In one particular abduction case, somebody had grabbed one and by the movements of the arms they could see that the Grey had been programmed to fend off an attack by moving its arms in a certain way. All it really had to do was turn around and back away. It points out that they are being programmed.

I would like to cover the incident where the astronauts were supposed to have said that they had an alien spaceship in visual contact. Apparently after very thorough research by Bob Oechsler and his group in Maryland, it turns out that this transmission was sent from a 12 square mile area which included CIA headquarters and the NSA facility at Fort George Meade. Apparently it was a test of some kind to see if the public would "bite". I really don't know what it was, but that's the area that it was sent from. It was a very sophisticated

transmission. It was Blaha's voice, but it was not coming from the Discovery. I thought that was interesting.

I would like to briefly talk about Bill Cooper. George Knapp did a very brutal 20 minutes about Cooper. There are a number of things that are very suspicious about Bill, but I would like to tell you that I believe that Bill Cooper did have access to information in 1973 when he was in the Navy, and that the information did include some information about some of the dealings with the aliens. It was my understanding when I first met Bill, that when he was stationed at Pearl Harbor he had the key to a classified area. He would go in there at night and read some of these briefings. That's what he told me. Later on, he started saying that he was part of an intelligence briefing team. I don't think he was; at least that's not what he told me. Also, in the beginning he limited his verification of what I was saying by saying "look, I can only support 50% of what you're saying". It later became 150%. Nothing is black or white - it's all shades of Grey. Cooper did have access to some information in 1973, but not as much as he would like you to believe he did. You can take that for what it's worth. He has done some very strange things. He's threatened me on at least four occasions. He thinks that I'm with the "agency" and involved in disinformation, so that's his deal.

The other day, a guy came up to my house who was out in the forest with Charles Halt the very first night of the Bentwaters incident that something landed. There was a rectangular object that landed, and he actually jumped on top of it. He said he could look down inside the object. He has never made any public statement at all. I never thought that I would ever get to meet him. He did in fact confirm that the incident did in fact happen.

As far as an update on AIDS is concerned, AIDS was developed by the Navy in 1972. The specific doctor that developed it was a doctor by the name of R.M. Donner. The initial AIDS research was financed by Congress. July 1, 1969 is when they had the hearings. This is a copy of the DOD appropriations report for 1970 (Ed note: See July 90 Leading Edge). It was chaired by Robert Sykes. The testimony reveals exactly what they wanted - a biological virus for which there was no known immunity. They finally got it developed in 1972 and started doing experiments. The biggest experiment was in 1977/78 when they released it in Africa, which is now 100% infected. In the United States in 1978/79 AIDS was released to the white male homosexual population through the Hepatitis B vaccine. The reason they wanted to start with the white male homosexual population was that they wanted to get it to spread very quickly, and they thought that people would not worry about it if they thought that only drug abusers or homosexuals were involved. That's what happened. The Navy goal was to infect 75% of the worlds population by April of 1991. Those are from top classified government documents. What's interesting is that by the present rate of infection, 75% of the population will not be infected by the April 91 target, so what we're looking at is other ways the government may have of spreading this disease. I am kind of happy I don't live in California, where those helicopters are flying up and down spraying for the Medfly.

Whitley Streiber. I heard the other day that he's become a recluse, that he's destroyed emotionally by the reception of Communion and his second book Majestic, even though it's an excellent book and I would recommend it to anyone who wants a good outline on what the Government did in 1947 when they recovered the saucer at Roswell. It's an excellent book. One of the interesting things about the book is the two autopsy reports in the back. They are absolutely the truth. I don't know where he got those - the original reports about the two aliens. Whitley used to call me all the time in the middle of the night and chat for two or three hours up until about a year ago.

A little more about Bob Oechsler. Oechsler has done a lot of research in the Chesapeake Bay area. There's really something big going on there. Basically, it appears the HQ of MJ-12 is back on Kent Island or somewhere back there. A lot of EMP research and engineering is going on. A lot of underground activity - all kinds of stuff. What's interesting is that about a year ago he ran into Admiral Inman, who is supposedly one of the MJ-12 members. Bob stopped him and asked to be put in touch with somebody in MJ-12. Inman took Bob's card and looked at him with kind of a half smile and said, "let me see what I can do." About 6 months later he called and set up a meeting for Oechsler to go and see General Stafford, who is head of some kind of organization at the Pentagon. Oechsler went to see him and went down some ramps under the Pentagon and into this one corridor where he was required to walk through what he thought was a metal detector, but when he walked through it he felt real dizzy and walked in Staffords office still kind of reeling from this thing. He asked Stafford, "what in the world was that?". Stafford said, "don't worry about it, I had a headache for six weeks after first going through that thing". Bob had a lot of strange things happen to him. Supposedly in September 90, there is going to be another release of government information about UFOs or aliens. Here we go again. Supposedly Oechsler's going to be a part of it. Supposedly they're going to show a saucer and a dead body. I've heard that so many times I don't believe it. Oechsler is supposedly being briefed on some of the things the government is doing. He was sent down to Ellington AFB near Houston and shown a government research laboratory that we have down there that was 40 feet long, 20 feet wide and it was a zero gravity chamber. It had a very bright light at the top and everybody was floating. Oechsler is not quite sure where this lab is. He was taken there in a black helicopter that did not look like any of the helicopters we have in inventory. It was very smooth and looked like it was molded in one piece. Oechsler said that it sounded like a helicopter until it was 25 feet off the ground and then there was dead silence. He didn't hear a thing. He estimates that it was near Pensacola where there was a large platform and a number of buildings. He was taken into the building and shown the primary SDI facility, which was a great big room, and suspended on the ceiling was a 25'x25' three dimensional video "presentation". On it was represented the southeastern portion of the United States and then there was a grid pattern that came up to what was represented as 300,000 feet. There were "vortexes" represented here and there in the gridwork. There were little dots labeled "ASC's". We don't know what that means. You could see flights of some type enter these "vortex" areas and apparently go underground,

but if one went down in a different area, it would split up into eight blips. Interesting. There were only men in there, no woman. Everybody had on black pants with a white shirt buttoned up to the collar with a tie. No one smiled. Oechsler doesn't know what the place was. He was just shown it and given no other information. He tried to get in touch with General Stafford after that, but so far no luck.

The aerospace engineer that I spoke of confirmed that Dulce existed and that we do have a base on the Moon. I have several other sources that confirm the base on the Moon. They go there regularly. I don't know what they do there, but it does exist. He also confirmed the existence of the base on Mars. It's already there.

I have come up with some information during the past month about the Challenger accident from an individual who has worked at Cape Kennedy for a number of years. Apparently, the Challenger was blown up by the Russians. It was a KGB unit that did it. They did it using 17 Libyans who had access to the protected areas. An explosive charge was put on the strut that held the SRB to the main fuel tank and it ignited, banging the SRB against the fuel tank. It was the only launch where all the Russian trawlers pulled out several hundred miles into the ocean away from the Cape. There was also a video and radio link that was held aloft by a balloon, and the night before the launch the cable was cut so they couldn't get any pictures on launch day of the SRB strut area. There were also a number of other things that happened. Apparently, the Soviet Chernobyl incident was caused by the United States in retaliation for the Challenger incident. Now I am looking into that, and I will let you know what I find out.

I went to a very interesting talk by Bill Hamilton, who's here tonight, and after the talk we went on a very interesting mission to check out the Lockheed skunk works near Los Angeles. This skunk works has done a lot of secret work. As you've read in the papers, they're moving Lockheed to Georgia to do a lot of the work down there. They are also closing down the plant at Burbank, saying that they are going to move it down to Palmdale, but we think they are moving operations to the Tehachapi Mountain area, where there already is an underground facility in the western portion of the Antelope Valley. There was a lot of activity going on there. We think that saucer craft are being produced at this underground facility using other types of technology. Bill is here today and brings the information that the silo doors at this so-called "Tehachapi Ranch" have been seen to open and a saucer shaped craft has flown out of it. I would have like to have seen that Sunday night.

The other day I was over Bob Lazar's house and we were looking through a classified book on nuclear bomb technology up until 1960, and we were discussing how many bombs have been exploded in space. Up until 1960 there were at least four. The first one was in August 1958 and was called TEAK. It was a hydrogen bomb exploded 252,000 feet over Johnston Island. What's interesting about this is that I don't think

we "had that kind of capability" in those days of launching things like that. I took out my Janes "All the Worlds Spacecraft" and went back and found out that after Sputnik was launched we had (as far as the public was concerned) quite an effort to get something up there ourselves. That was the Redstone and Vanguard rockets. It turns out that the first launch was successful but every one after that failed. We just couldn't get anything off the ground. All that stuff was just a ruse, because a year later we were launching hydrogen bombs over Johnston Island that weighed two tons. The public was told that we couldn't even get a three pound object into space. Apparently there was a classified launch facility in the Pacific.

With regard to the South African incident, it appears that it was a hoax perpetrated by James Van Gruenen, who has a history of hoaxes. We don't know what the final outcome is. Van Gruenen even offered one producer a "chance to meet an alien from the Space Council". This producer contacted me and I told him to check Van Gruenen's background.

I got a call from Linda Howe a couple days ago, and she told me that there was a discussion by VP Quayle about reorienting the SDI toward shooting down an incoming asteroid and that it was in a paper. She's supposed to send me the article. But is interesting is that we've heard this story for the last two or three years about an incoming asteroid. It's obviously under intelligent control, it's putting out radio emissions. Supposedly it's on the edge of the solar system now, heading this way. I have at least three confirmations that it does exist. The code name is supposedly Wormwood. One of the confirmations came from a friend of a guy in the CIA. They were out one night and the CIA guy was drinking heavily and was very depressed. His friend asked him what the matter was, asking "is it the thing that is coming in from space?". The agency guy dropped his glass and said, "how do you know about that?". That's one of them. If we are reorienting SDI in that way, that opens a lot of questions about what is going on.

GOVERNMENT SCIENTIST ROBERT LAZAR REVEALS AREA S-4 DATA IN 1989

November 13, 1989

Paranet Information Service (Denver, CO) — In our continuing coverage of the remarkable revelations coming out of Las Vegas, Nevada, here is the next installment to the program aired on November 13, 1989 by television station KLAS-TV and George Knapp.

NEWS ANCHOR PERSONS:

A former government scientist has alleged that the U.S. military is flying recovered UFOs at a secret base in the Nevada desert. The allegations about the secret facility near the Groom Mountains first surfaced on Eyewitness News on last Friday (November 10, 1989).

Scientist Bob Lazar says that there are at least nine of the flying saucers being tested and that they were not built on Earth. George Knapp has more on the continuation of our series on UFOs.

Lazar: "Yeah. It was obvious it came from somewhere else other than Earth."

Scientist Bob Lazar was convinced that the technology he saw being tested at a secret base in the Nevada desert is of alien origin, and for Lazar the proof is, at least, partially in the furniture. One of the nine flying disks he says he saw at the base, which was designated S-4, looks exactly like this UFO photographed in Europe (photo of UFO shown). Lazar called it the "sport model."

Lazar: "I gave everything names -- the top hat one and you know the Jello mold and the sport model operated without any hitches at all. I mean, it looked new. If I knew what a new flying saucer looked like. One of them looked like it was hit with some sort of a projectile. It had a large hole in the bottom and a large hole in the top with the metal bent out like some sort of large caliber, 4 or 6 inch, had gone through it."

Even before he saw the sport model operate, Lazar says, he suspected that the ship came from somewhere else. The realization slapped him in the face the first time he glimpsed the inside of the disk.

Lazar: "I got to look inside and it had really small chairs. I think that was the first confirmation I had. That was just a shocking thing because everytime before that I was able to label it. This is just a little advance that a group of scientists had formed and, you know, they're keeping it secret. We could have built a big disk like that, that's no problem. We could have adapted the use to make it fly but why does it have little furniture inside? Things began to click together just all too fast."

A few of the disks had been completely dismantled to find out how they worked, Lazar says, but others were fully operational. A Japanese TV network created this animated version of Lazar's story after his first interview with us aired in May (showing video). Lazar says the dramatization is similar to a test flight he witnessed.

Lazar: "The bottom of it glowed blue and began to hiss like any, like high voltage does on a round sphere. It's my

Impression that the reason that they're round and have no sharp edges is to contain the high voltage like, if you've seen a high voltage system's insulators -- things are round or else you get a corona discharge. In either case, it began to hiss as in high voltage and it lifted off the ground quietly except for that little hiss in the background, and that stopped as soon as it reached about 20 or 30 feet.

Lazar says the test of the sport model was a short one -- that it made only a few moves before setting back down. He didn't see who was actually flying the craft, but was very impressed, nonetheless.

Lazar: "Well, there's no action reaction system to it. There's no, like in a jet engine, exhaust gas being thrown out -- no propeller, no noise. It's just, for all intents and purposes, magic."

To Lazar's knowledge, the flying disks are not being used, for say, any flights to Jupiter. He said excessive caution and intense secrecy contributed to the plodding pace of the program and were a main source of his disenchantment.

Lazar: "It's just unfair, outright, not to put it in the hands of the overall scientific community. There are people much more capable of dealing with this information, and by this time would have gotten a lot further along than this small select group of people working out in the middle of the desert. They don't even have the facilities, really, to completely analyze what they're dealing with."

Gene Huff: "Well he was being quiet. If he kept me abreast of anything, he kept me abreast of the security checks -- they'd randomly drop by his house. They'd threaten his life; they'd threaten his wife's life. They had done all that so we really didn't converse, I mean, he really was adhering to the program.

Gene Huff is a Las Vegas real estate appraiser. A regular guy who just happens to have a friend in the flying saucer business. He learned about Lazar's S-4 experiences only after a long period. Lazar is anxious for people to know that he didn't just run right out and spill the secrets of the universe, and that some things are properly kept confidential.

Lazar: "I did not believe that this should be a security matter. Some of it, sure. But, just the concept that there's definite proof, we even have articles from another world, another system, you just can't tell everyone. A lot of people don't believe that, but I do."

When we reached what he felt was his bursting point, he took Huff and a few others to the edge of the Groom Mountains to see the flights for themselves. A total of five witnesses on two consecutive weeks managed to dodge security patrols long enough to see the strange glowing object lift above the mountain.

Huff(?): "It came up above the same mountain. It moved around. It did a step move -- it actually went up in the air like this (showing details with hands) and it hovered then dropped way down, then it just floated around and cruised around. It starts coming up the mountain range...."

This home video tape was recorded during one of the trips to the Groom Mountains (showing video tape. A lot of talking... object in sight... mention of brightness of the object...)

Admittedly, the tape proves very little by itself because, with the distance and darkness, there are no reference points other than the alleged flying disk, but Lazar's information about the time and location of the test flight proves correct -- not once but twice. That, according to our off-camera interviews with each of the other witnesses. Gene Huff describes his second sighting: Huff: "through the telescope we could see an elliptical-shaped light. You can only get so close even with a telescope to a secure facility. Anyway, it came up by us very rapidly. It glowed and glows brighter like a star and we almost got the feeling that it was going to explode, it glowed so brightly. We backed up behind the car, then it went down and glowed back up a little bit, and then very softly glided back over, back where the mountains... where it came up, hovered for awhile, and then that's that!... Just like you see in the movies."

Bob Lazar isn't the only person to claim "inside knowledge" of the flying disks at the test site -- he is just the only person to say so publicly. We have communicated with several people who say they know of the saucer program. A technician in a highly sensitive position told us it is "common knowledge among those with high security clearances that recovered alien disks are stored at the Nevada test site." A Las Vegas professional, who once served in the military and was stationed at the test site, said he saw a flying disk land outside the boundaries of Area 51 -- that it was quickly surrounded by security personnel and that he was taken away and debriefed for several hours. A man who once worked at Groom Lake as a technician, at our request, wrote this letter explaining how he inadvertently walked into the wrong hangar and saw what appeared to be a large metallic disk under a tarp. It was being examined by men in lab coats. And, an airman who worked at Nellis at a radar installation says he and his fellow servicemen watched over a period of five nights, unusual objects flying over the Groom Mountains. He says the radar images indicate the objects zoomed into range at speeds of 7,000 miles per hour and then would stop on a dime, and that nothing we have is capable of doing that. The airman says that when word of his sighting got out, he was ordered to turn off his radar sensors for that area and told to keep quiet about the matter because it did not happen.

None of this means that the military is actually flying alien spacecraft in the Nevada desert. It could all perhaps be explained as some other secret program. Lazar insists that's not the case.

We put the matter to the U.S. Navy, which according to Lazar is running the saucer show. Four different naval offices were contacted. All denied having any information in their files. The Naval Research Lab said it conducted a thorough search but found "zip." Naval intelligence said much the same thing, adding, it is not required to create a file where one doesn't exist. A side note: We also requested files on a UFO sighting

over Tremonton, Utah in 1962. The Navy spent more than a thousand hours studying film of that sighting -- a fact that's been noted in several publications -- but, for purposes of our request, the Navy couldn't find those files either.

Lazar: "The group that runs this project, whether it really is the Navy or they just say that, apparently these people have executive power -- they don't report to anyone."

Just over this ridge (showing a photo of Area 51), tucked inside the test tubes of a hidden government base, the secrets of the universe may be unfolding. The area is designated S-4, and according to one man who claims to have worked there, S-4 harbors scientific achievements that would astonish our deepest thinkers. It is technology that, if it exists, could change the world, but is allegedly bottled up by military minds.

Lazar: "It's not an overall government project. It's not something that Congress appropriates money for. 2 billion is for this; 16 billion for flying saucers; 8 billion for Star Wars. It doesn't go like that. I don't believe that they have any knowledge of it at all."

The technology that Bob Lazar says he saw extends far beyond flying saucers. An anti-matter reactor allows the spacecrafts to produce their own gravitational fields, he says, such a technology, if real, would answer UFO skeptics who argue that aliens could never visit Earth because the distances between worlds are too great, even at the speed of light.

Lazar: "Gravity distorts time and space. Just like if you had a water bed and put a bowling ball in the middle, it warps it down like that -- that's exactly what happens to space. Imagining that you were in a spacecraft that could exert a tremendous gravitational field by itself you could sit on any particular place and turn on the gravity generator and actually warp space and time, and fold it. By shutting that off, you'd click back and you'd be a tremendous distance from where you were but time would not have even moved because you essentially shut it off. I mean it is so far fetched, people... it's difficult for people to grasp, and as stubborn as the scientific community is, they'll never buy it, but this is, in fact, that's just what happens."

Actually, Lazar's explanation is very close to mainstream scientific thought, and can be traced directly to Einstein. The difference is scientists regard it as theory only. There is much that science still doesn't know.

Dale Etheridge (Scientist): "There are people who say that our main problem with that is we don't know what gravity is. It's this magical force that acts at a distance. We can describe how it behaves -- that's what the law of gravity is -- it's just a description of how it behaves, but it says nothing about what gravity really is."

We'll use Etheridge as our barometer of scientific thought. He says we cannot produce gravity; that there's no such thing as a working anti-matter reactor, and that we have yet to figure out a way to get around the speed of light. He also concedes, though, such things are possible.

Etheridge: "Yeah. And really we don't know what's possible as there could be other civilizations out there several hundred years or so -- a thousand years, even a million years ahead of us -- that have found a way to circumvent this. We have no way of knowing for sure."

Lazar: "Well, the thing is when you harness gravity, you harness everything. It's the missing piece in physics right now. We really know very little about gravity."

At least that's the way it used to be. Lazar says the technology to harness gravity not only exists but is being tested at S-4. And, if such technology is beyond human capabilities, it must have come from some place else. It's more than conjecture, he says, because he also saw an element that cannot be found in the periodic chart. The element, called 116, can be stored in lead casings much like this one (showing a lead circular container). Lazar says the government has 600 pounds of it, and it cannot be made on earth.

Lazar: "It would be almost impossible; well, it is impossible to synthesize an element that heavy here on earth."

Interviewer: "At least right now."
Lazar: "I don't think that you can ever synthesize it. The amount of... you essentially have to assemble it by bombarding it with protons if... atom by atom, it would take an infinite amount of power and an infinite amount of time. The substance has to come from a place where super-heavy elements could have been produced naturally."

And what sort of place is that?
Lazar: "Next to a much larger sun where there would be greater mass. Maybe a binary star system -- a super-nova -- somewhere where there is just a bigger release of energy to synthesize these things naturally. It has to be a naturally occurring element."

116 is the fuel for the anti-matter reactors, he says. By bombarding 116 anti-matter is produced. A kilo of anti-matter could produce the energy equivalent of 48 ten-megaton hydrogen bombs, and comparing the energy potential of anti-matter to, say, the Hoover Dam would be like comparing planets to grains of sand. 116 could also make one heck of a bomb.

Lazar: "We're talking about hundreds and hundreds of megaton off a small piece of it. It sounds incredible, but total conversion of matter to energy would release that amount of power. And it isn't that difficult to take... get the energy out of it. So it's not something you'd ever want to fall into anyone's hands."

The dangers associated with 116 and anti-matter may be the reason Lazar was hired to work at S-4. There was an accident, he says, back in April 1987. An accident that was passed off as an unannounced nuclear test.

Lazar: "Some people got killed. I was told flat out I was one of the people that were to replace these guys."

Is this why the government might be keeping the whole matter a secret? Because of the military potential of alien technology? Lazar says he believes the Soviet Union was once part of our research on the flying disks, but that the U.S. kicked the

Soviets out after making some sort of discovery. He also believes the program at S-4 is operated with funds allocated to Star Wars research, but says he can't prove it. Some UFO researchers suspect the government is test flying alien craft so that it can one day master the technology and claim it was made in the good old U.S.A., thus obscuring the possibility of alien visitations.

Stanton T. Friedman: "I think they have the duty to inform us. At least to the bare bones of what's going on. I don't want technological stuff put out on the table. I mean, I worked on classified projects for 16 years, and I don't think we need another weapon's delivery system. But I think the government does have the responsibility to release information that, indeed, the planet is being visited. Probably it should be done in conjunction with the Soviets."

Lazar: "I don't think that it will get to that level. They're not going to have a fleet of them and fly them around and... I don't think you need to do that. If you're looking at them from a weapons point of view, you're looking at an incredibly powerful device. You only need one to operate. You don't ever need to come public with it. You may want to learn more about it should it ever break which is... might be what they're doing. Oh, they've got a few. Yeah."

Lazar is the first to admit that his story is tough to swallow. He submitted to polygraph exams that opened up sensitive parts of his personal life, and fully expects to be ridiculed or perhaps punished for his revelations. His desire to explain what really happened at S-4 took us to Layne Keck, a licensed experienced hypnotherapist who quietly and privately tried to help Lazar remember details of the many briefing papers he says he read.

Keck: "I have no clue as to what we were getting into, and he started saying that there were pictures of what I thought was desks on the wall. Well as it turned out, it was disks that he was referring to. And, at that moment, I realized we were into something that was pretty heavy."

Keck does not exaggerate his claims for hypnosis. He regards it as a useful tool for uncovering some lost memory. He says people are quite capable of lying under hypnosis, but says the opinion of Lazar's truthfulness

Keck: "It tells me that his subconscious mind believes totally all of these things."

Lazar has long suspected that his government employers used some sort of mind control technique to prevent him from disclosing too much about S-4. While he says he has vivid conscious memories of the saucers and other technology there were other memories, that even now, remained locked, which is why he sought out Keck in the first place. Keck is convinced that someone really did mess with Lazar's head.

Keck: "Also they used primitive fear in threatening those in his environment if he did bring this information forth. Also, it appears that maybe there were some chemicals used."

Lazar: "Nah, I'm not going to change anyone's mind. That is not my intention. I'm just relaying the information forth. The job that I went through. It is a fantastic thing. It's a fantastic story. I can't take people there to show them what was going on, and uh, you know, I don't expect anyone to believe it."

What if he is right? What if aliens are here? How would this change our view of the world? Our most fundamental beliefs, which is religion? We'll know more on that tomorrow.

Update on Robert Lazar

In August of 1990, someone in the Federal system goofed and sent Robert Lazar his W-4 statement; this came after Lazar had made the discovery that the government had taken the time to try and erase his past. A partial picture of the W-4 was then broadcast on Las Vegas channel 8 by George Knapp. It showed that Robert Lazar had worked for the past year under the Department of the Navy. What the station didn't broadcast was the portion of the W-4 that showed his employee ID number - part of the number was "MAJ". Efforts at trying to set up Lazar in order to discredit him failed in August when Lazar beat the "pandering" charge levied at him for installing an electronic security system for the owners of a brothel. It was rumored that the local authorities had been making use of the illegal brothel themselves before Lazar was hired to install the security system and that because of that they were bound not to give Lazar a serious sentence for the trumped-up charge. Whether or not the local authorities had in fact used the brothel has not been established.

Correlation Between the S-4 Disks and the Meier Disks

Lazar drew a picture of the craft he dubbed the "sports model" during the course of his expose. Researchers immediately noted that the appearance of the craft was identical with one of the craft seen in the Meier photographs and films. This would explain why the government has been so insistent on confiscating Meier photos and discrediting what Meier revealed. As mentioned elsewhere in the book, it is very possible that the US or US-allied individuals have been using these disks and masquerading as someone else in order to keep their operations on a covert basis. Refer to the picture of the disk shown on page 177.

Notes

PHOTO TAKEN OVER S-4 TEST SITE

On March 28 , 1990 at the Area 51 (Groom Lake) Test Sight at 7:30p.m. for around 10 minutes a light, acting in a very erratic manner, appeared close to the S-4 area of the test range about 10 miles south of Area 51. It appeared once again at 4:30 a.m.

The light came up from behind the mountain range, approximately 8 miles away. The sky lit up like lights from a city. The S-4 test sight for some reason must have turned on their lights. We snapped a few photos, never thinking they would turn out so clearly.

Also while we were there a tan Bronco, no license plates, no tail lights, 2 men (young) in desert fatigues with baseball-type caps approached us and took our license plate number. There was no conversation and when they drove away, we noticed they had no tail lights! We were parked right off the 29½ mile marker.

Just as we thought we had seen the last of these strange fellows they came back and parked across from us and to the back of our vehicle with their motor running. We had a friend with us that tried walking up to their Bronco and just as he approached their vehicle, they jammed it in reverse and turned around and sped off down the main highway. Again, we notice they had no tail lights.

After they took down our license plate number, they turned off one headlight as if to signal someone up the dirt road. They did this twice. Here is one photo that we were lucky to have developed.

S-4 DISK

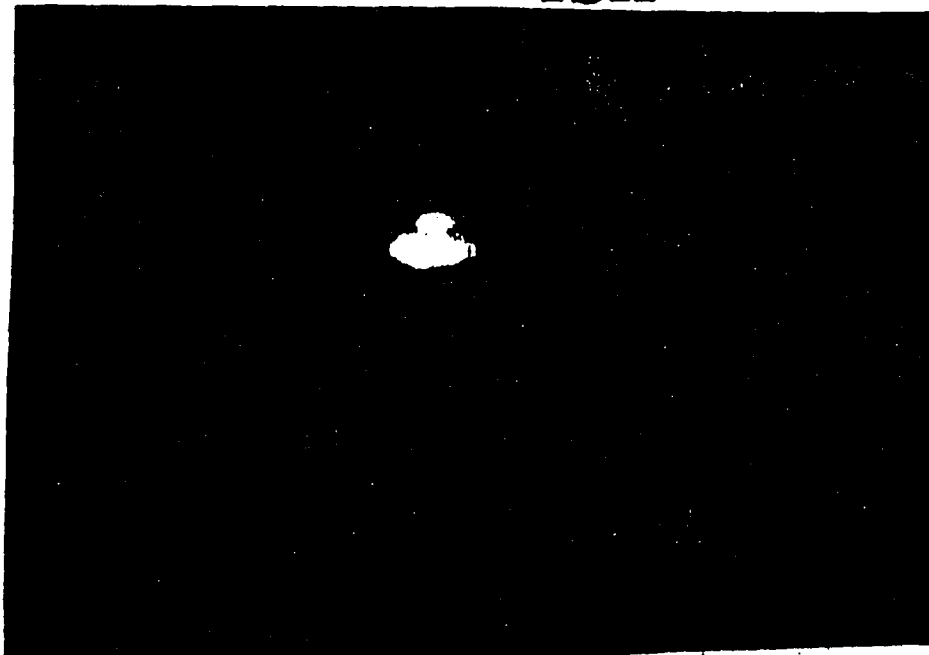

Questions and Answers from
Robert Lazar
on Radio
November 1989

C= Caller L= Lazar

C: Why are you going public with this thing?

L: Well, the thing that essentially was the straw that broke the camels back was after I left the program I kind of became concerned about "what happens now?". I made a routine request for my birth certificate, which I needed for ID purposes, and I was told that it didn't exist - that I wasn't even born at that hospital. I sat on that for about a week and then I began to inquire at previous jobs and also at schools, and that info was also gone. I kind of got the idea that soon "someone" was going to disappear, so that's when I contacted the TV station and essentially let everything out.

C: But you left the program under amicable circumstances?

L: No, but that is a long and involved story that I don't really want to get into.

C: Ok, that's fine. Are you afraid of any repercussions from the government?

L: Oh yes. I was really concerned at one time, but less so now. You still keep it in the back of your mind.

C: I imagine that if anything were to happen to you now, that it would cause such an uproar that the last thing they would do now would be to go anywhere near you.

L: Right. As someone in the media said, if they are following me now it is to make sure nothing happens to me.

C: In the program, did you witness any vehicle models that were working and operational?

L: Models?

C: The vehicles themselves.

L: I only saw one operate. I saw one at close range when I was at the area and then one at extreme distance, about 15 miles away, when I brought some friends up to look at it.

C: Using the technology which is used, the craft are very agile, aren't they?

L: Oh yes, very. In one specific mode of travel.

- C: One specific mode? In one direction at a time?
- L: No. There are two modes of travel. There is a low speed mode and a high speed mode. I don't remember what they called the modes. They had specific names for them.
- C: What was the size of the staff working on the project?
- L: Twenty-two people that I knew of in the area that I worked in. How extensive the rest of the facility was, I don't know.
- C: I gathered from one of your earlier interviews that you were frustrated by the size of the staff- you thought that it should be larger?
- L: Oh yes, much larger.
- C: More could have been learned more quickly in the program with a larger staff?
- L: Sure. I mean, twenty-two people... come on.
- C: Do you think we understand enough about alien propulsion technology to build our own vehicles? Are we even close? Do we know what's going on?
- L: Yes, we know what's going on, but the problem is substituting earthly materials. There is really no way of getting around that.
- C: Can you explain about element 115 and how it is involved in the construction of the vehicle?
- L: Everything seems to come down to 115. It's a superheavy element, and it seems that as you get into the heavier elements (and I'm sure this property extends into as yet undiscovered elements) that the atomic gravity wave inside the atoms holding things together begins to extend outside of the atomic structure itself, and it's this wave that can be tapped off in small quantity, amplified, contained and used for a useful purpose.
- C: Do you know why you're on this planet?
- L: You've got me.
- C: Do you think that they are flying these vehicles in our city areas at any time?
- L: I really don't know. I was witness to only a couple of tests. I don't know how far they go. I think they're very careful with them. I personally don't think that they are whipping them around the solar system. I don't know how proficient they are at operating them. I really don't know.

- C: Do you read any UFO literature that has come out?
- L: Nothing really. I occasionally get handed little tidbits here and there and glance at them, but I really don't get into it.
- C: You mentioned something about the Billy Meier case. You mentioned that you had seen some pictures.
- L: Yes. What caught my eye was that one of the craft looked strikingly similar to the one I called the "sport model".
- C: What did you think of that similarity? Did it puzzle you?
- L: Yes, because I had originally discounted the Meier stuff, but that craft looked amazingly like the one that I worked on. I saw another thing on that book. It showed a grassy field with three round indentations in the ground. That would coincide with the three gravity amplifiers on the bottom of the craft and the imprint that they do make, so it kind of makes me believe that it really did occur.
- C: You said once that you didn't really share the views of Bill Cooper and John Lear as far as the "big picture" was concerned. Could you tell me what you meant by that?
- L: Well, I am not exactly sure what each individual story is. I do agree with both of them in the fact that there are alien craft here. I just haven't seen any evidence myself relative to the other parts of what they say. I don't know what these gentlemen have found out on their own.
- C: Do you believe that there are benevolent creatures in the universe?
- L: Oh, sure.
- C: Do you think that the craft are being flown by alien beings or that the government is doing it?
- L: I think that the ones that we are testing - the one that I was involved with - I think it's being flown by the military. Whatever else is going on, I don't know.
- C: Do these craft appear to be shuttle craft - not the main craft?
- L: I don't know how you would differentiate between the two.
- C: People speak of them joining up with other craft and going out into the atmosphere. I was wondering if some of these models could be classified as shuttle craft.
- L: Definitely not. They are small. I'm guessing about the mid 30 to 40 foot range in diameter. There's not a whole lot of room there.

- C: Is it true that there are more engines than there are craft at site S-4?
- L: That's a good question. Hmmm. Well there are nine craft...I really don't know. There's certainly more fuel than there needs to be.
- C: In view of the fact that they have taken away your livelihood, I hope you go nationally. I think that all this should be in the hands of the scientific community where we can get some good out of it. We should take it out of the hands of these power mongers.
- L: I agree one hundred percent.
- C: When you were involved with the program, did you have an opportunity to go inside all nine spacecraft?
- L: No..just the one.
- C: When you were in the craft, did you notice any writing or anything that would indicate that the craft was from another world?
- L: No, not on controls or anything....but I did see some evidence of writing.
- C: When you saw the flight demonstration of this disk, were you the only person who was there who saw it operate?
- L: No, there were several people. I was standing next to the person who was in radio contact with the craft.
- C: How long did this demonstration last?
- L: It was a short duration. It lifted off the ground and went a foot to the right and a foot to the left and back down. It was very short.
- C: You never saw who was at the controls?
- L: No, because when I was brought out it was already out of the hangar and was on the runway at some distance. I don't know how it was brought out or who got in it. I can only guess.
- C: Is this entire installation underground?
- L: No, its not really all underground, but butted up against the side of a mountain. Its inside the mountain.
- C: Do you feel that the billions of dollars that are being spent on the space program by the administration is a waste of money, as we already have these ships in our possession?

- L: No, because look at all the technology that we did get out of the space program.
- C: Was it ever disclosed to you that these craft were on loan to us - that there was a chance on them being repossessed at any time?
- L: No. None of that was ever disclosed to me. The origin or anything about it.
- C: I heard a rumor that your car was shot at recently.
- L: I was shot at in my car.
- C: You said there is more fuel than necessary at the test site?
- L: Yes. I don't know exactly where it all is, but there is 500 pounds of it.
- C: Five hundred pounds of element 115?
- L: Yes. It takes 223 grams per craft. There is definitely an abundance of fuel there.
- C: Can you describe the underside of these ships?
- L: No, because I only saw the side view of one of the craft. The other ones were sitting on the ground. The underside is essentially flat. There might be some features under there but I don't know what they are.
- C: Are aware of any time distortion in the saucer itself while it is running?
- L: Yes. There have to be distortions.
- C: What about size distortion within the ship? I have heard people say that some of these ships have been bigger on the inside than the outside.
- L: I have heard that too, but I personally have not seen any evidence of that.
- C: What about the low and high speed modes and the control factors involved....and what the ship looks like in these modes?
- L: Ok. In the low speed mode the craft is actually very vulnerable. It sort of bobs around and it's sitting on a weak gravitational field. It's essentially sitting on three gravity waves. It can

focus the waves behind it and essentially keep falling forward. In the second mode, they increase the amplitude and the craft begins to lift. It performs a roll maneuver. It begins to turn over. As it begins to leave Earth's gravitational field, they point the bottom of the craft at the destination. This is the second mode of travel where they converge and focus the three gravity amplifiers on a point that they want to go to, then they bring them up to full power, and this is where the tremendous time-space distortion takes place. It whips them right to that point.

C: Did you actually bench test a small unit away from the craft?

L: The reactor, yes.

C: About how large is this? Can you describe it?

L: The device itself could be described as a plate about 18 inches square. There's a half-sphere on top where the gravity wave is tapped off.

C: Are there any other items or subjects that you won't talk about in regard to what is going on at Groom Lake?

L: Uh...no I don't think so.

C: Do you have future plans for more publicity?

L: There are several networks that are interested. Uh...I haven't anything officially.

C: Would you do it?

L: Yes. I would do a major network thing, sure.

C: Do these particular craft create harmful radiation in the area where they operate?

L: No.

C: How about the Cash-Landrum incident?

L: It sounds like a really poor attempt at us producing a nuclear powered craft. Really dirty and spewing nuclear material all over the place. It sounds like something we would make. It really rings of human construction.

C: Do aliens appear to be of physical makeup similar to us? Can you tell by the small seats and the design?

L: Certainly they are smaller. I read some material pertaining to what a typical Grey would be like.

C: Tell us about an anti-matter reactor used for transportation.

L: Well, it would be a tremendous electrical power source.

C: Have you been contacted by any of the Mercury workers?

L: I don't know what the situation is with those guys - whether they're for real or not. I got messages through people that said that there were two of them at S-4 being tortured. I don't know what the story is.

C: Have you had contacts with any other scientists that don't work there?

L: Yes. People from Los Alamos.

C: You received contact from them after you announced what was going on, and they wanted to know what was happening?

L: Yes. There were a couple of them that I gave information to as we were going along.

C: If you had other people to back you up, it might lend credibility to what you are saying.

L: That was the idea of getting it on the news. I would be able to shake the tree and have these other guys come forward and be able to corroborate the story, as well as having the sample of 115 under my belt. The whole plan backfired.

C: The rest of them don't have the guts to do anything.

L: I wish they did.

C: I have heard talk about a big underground base up there. Do you know about that?

L: I have heard that, but I don't have any first-hand knowledge of the underground stuff.

C: If the aliens that have the UFOS are so advanced, how would it seem that the government came into possession of these craft unless the aliens wanted them to have them.

L: Hmmm. I don't know. They look in very good condition. They don't look like they were crashed. It looks like they were given - it might be the case.

C: I heard on one of the broadcasts that a friend of yours made a gravity wave controller and you bounced golf balls off the gravity field.

L: Yes.

C: And about the candle and that the flame stood still in the gravity field...

L: Yes.

C: And the disk that you saw appear.

L: Yes...a little disk.

C: How large was the force field created by the antimatter device?

L: I would say that it came out about 20 inches from the surface of the sphere.

C: Just above the device?

L: Yes, above the sphere. Its a half-sphere sitting on a plate. The field surrounds the half-sphere. They tap the field off using a waveguide.

C: And the candle doesn't melt and the flame stands still while in the field?

L: Yes.

C: Do we know anything about the way of life of these aliens?

L: I don't know. I would like to know. You assume that they mass produce these craft, so there must be some kind of factory somewhere. There must be workers in the factory. The questions are endless.

C: Did you have a badge when you went to work. What did it look like?

L: It was a white badge. It has a light blue and a dark blue diagonal stripe through it. On the top it says MAJ12, but the clearance level is called MAJESTIC. My picture was on it.

C: Did it have the word MAJESTIC on it?

L: No, the only place I saw the word MAJESTIC was on my supervisor's badge. His badge looked slightly different. I don't know if it was an older design or not.

C: What was the breakdown of your duties versus what your co-workers were doing?

L: I have no knowledge of what the other people were doing.

C: You weren't working alone.

L: No, I was working with one other person who was breaking me into the program.

C: Did you ever see a spectrogram of 115? What did it indicate?

L: Basically that it was an unknown element. We did density and weight calculations, which are pretty basic. It was too heavy for its physical size.

C: Are there portholes in the craft?

L: Yes, there are square ones at the top.

C: Is S-4 also called Papoose Dry Lake Bed?

L: Yes. You can see the dry lake while looking out of the hangar doors.

C: What year were you working up there?

L: Last year

C: Can you list your credentials?

L: I have two masters degrees. One is in physics and the other is in electronics. I wrote my thesis on Magnetohydrodynamics. I worked at Los Alamos for a few years as a technician and physicist in the proton section, dealing with the accelerator there. I was hired at S-4 as a senior staff physicist to work on gravitational propulsion systems.

C: What schools did you go to?

L: I'd rather not say, the reason being that I am working with them under contract.

C: Why did you leave the Groom Lake project?

L: I don't want to go into that either.

C: Have there been any attempts made on your life?

L: Yes. It was six or eight months ago. I was shot at going down the freeway.

C: Are there any weapons on the gravity craft?

L: Not that I know of. Of course, the gravity generators themselves can be focused, and I imagine that could be used as a weapon.

C: How many alien people do they hold?

L: I don't know. How many people can you fit into a car? I imagine you could pack them in there.

C: This element 115 is extraterrestrial material?

L: Yes.

C: How do you suppose that they acquired 500 pounds of it?

L: I would imagine it came on one of the craft.

C: How close can people get to Groom Lake?

L: I think the closest you could get is about 10 miles.

C: A lot of patrols?

L: Yes

C: You said that we are no where near to the point where we can develop an antimatter reactor?

L: No. The first thing that we will come up with (and there has been talk of this) is an anti-matter weapon. That's the easiest thing to produce.

C: Are the nine disks at S-4 all different in appearance?

L: Yes.

C: From different star systems?

L: Most likely.

C: You said that the one that you worked on was from Reticulum?

L: Yes, that's what I read about it.

C: Do they have similar propulsion systems?

L: I was told that the reactors in all of them were similar. It is possible that the other ones have different systems.

C: As far as religion goes, where do the aliens fit in? Perhaps colonization?

L: I don't want to go into that. It will upset everybody.

C: What is the top speed of this craft?

L: Its hard to tell. This craft distorts time. They are really

not traveling in a linear mode. They are bending and distorting space and snapping back with it. The distance they can travel is phenomenal. Speed has little bearing.

C: Tell us more about the propulsion system.

L: The antimatter reactor provides the power for the craft and the basic low amplitude gravitational wave, which is piped into the gravity amplifiers at the bottom of the craft, where it is amplified into an extremely powerful wave and that is what the craft is flown on.

C: Do you know anyone who has flown on the craft to other galaxies?

L: No. I don't know if they have been used for that.

C: I wonder if there is any tie in with an Alternative 3 type escape plan...is there anyplace that you know of where this information can be found?

L: I imagine if any of that is true, it would be found in the midst of areas S-4 or 51. How to contact them and get them to talk is a feat not yet attained.

C: Are we going to see you at symposiums in the future?

L: No, I don't think so.

C: How long do you think it took them to make their journey here?

L: An extremely short time. I don't even think you're looking at days.

C: What is involved?

L: Well, they are traveling almost between time because of the way they distort time and space. They are traveling vast distances without the element of time being involved.

C: Do you think these aliens could be robots of some kind?

L: I suppose it's possible.

C: When Lane Keck talked on the air about you...did you request that?

L: No. George Knapp requested that.

C: Did you feel comfortable when you went into hypnosis?

L: Yes.

C: Is there any limit that these things can travel?

L: Well, I am sure they could travel to another galaxy.

C: Can you explain the gravity travel again?

L: The craft have three gravity amplifiers on the bottom. Assuming they are in space, they will focus the three gravity amplifiers on the point that they want to go to and pull it to them. They then shut it off and they're there.

NOTES

TWENTY-NINE PALMS UNDERGROUND BASE

It is commonly thought that Project Bluebook ended when the Air Force said it did in 1969. We acquired some evidence that it didn't during a 1988 investigation into a rather extraordinary case here in Nevada. The case will be related to you, but I will change the names in order to hold the confidentiality involved.

Sergeant Robert Williams was stationed in Honolulu during the period 1971 to 1973. He was a photographer who worked for the Aerospace Audio Visual Service (AAVS), which is headquartered out of Norton AFB, California. Williams is an extraordinary person. Of rather small build, he might be considered to be the least likely candidate for the experiences that he had while in the Air Force.

Williams says that while stationed in Hawaii in 1971, he was approached by *PROJECT BLUEBOOK* to work with them as a photographer, and did so until 1973. It is known that Project Bluebook was a multi-tier operation, and that reports of vital interaction with alien species never made it to the project, much less the public. This is the first corroboration that Project Bluebook existed until at least late 1973, at least in a form that was not visible to the public.

On *July 10, 1973*, Williams was approached by several high ranking individuals and given TDY orders and a Top Secret clearance and told to report to Norton AFB, California. Ron Smith, another AAVS photographer, was also given a clearance and orders to Norton.

Williams and Smith arrive at Norton AFB the same day, July 10th, and end up being herded into a briefing room and told that they were going to do some special work that involved photographing both aliens and an alien spacecraft. Both were then put into a large limosine that had blacked-out windows. The driver also remarked to them that they were about to photograph a spacecraft and some aliens, and attached a blindfold to both of them.

After a 45 minute drive, they arrived at their destination. At the destination, they felt the car descend and then the doors opened and their blindfolds were removed. Williams looked at his watch and noted how much time had passed since they left Norton.

Both Williams and Smith were briefed and led to a laboratory, where they saw three aliens laid out on tables. One of the aliens was still alive. The other two aliens were in the process of being autopsied. The aliens were wearing blue uniforms. There were six scientists in the lab and *two marine guards*.

Sergeants Williams and Smith then were told to photograph the aliens and the autopsies. The tissue of the alien bodies was black and the fluid/blood was green, which leads some to suspect a nourishment process that utilizes light. Williams says he was disgusted with photographing the autopsies and told Smith to photograph the dead aliens and he would photograph the live one. During the time when Williams was photographing the live alien, it died. It was looking at Williams when it died, and Williams felt a sensation like "something passing through him".

The scientists and the marines had blank expressions on their faces, like "they weren't all there". This indicates probable

inculcative programming or mind-control that is used in behavior modification of the humans at the base.

At this point, Williams and Smith were taken to an underground hangar of immense proportions, and there they were led to a disk that was slung in a huge net from the girders above. The appearance of the disk was as if the surface was metal under blue glass. Williams' assignment was to photograph the craft inside and out. The outside photography was to be done at varying distances in increments of one foot around the entire circumference of the disk. Later, when the photos were developed, it was noticed that the photos of the craft did not portray what was seen with the naked eye. The perspectives were different.

Williams was allowed to enter the disk. He discovered that the inside of what appeared on the outside to be a 35' diameter disk was gigantic, almost half a football field. Williams reasoned that there was a dimensional shift as one passed through the door to the ship. He noticed extremely unusual effects when looking out the door of the ship from the inside.

There were two scientists inside the ship when Williams entered. He asked them if they knew how it worked, and they replied in the affirmative, looking sort of bored, as if they had done this many times before.

After photographing the ship, the two men were loaded aboard another car with the windows blacked out, blindfolded, and driven the 45 minutes back to Norton AFB. From there, they both returned to Honolulu. The men noticed that no one would speak to them, even their wives. Smith, a very conscientious airman, disappeared AWOL and was never heard from again by Williams. Williams now works somewhere in Nevada.

That is the basic case as we investigated it, but our investigations went farther than this. It seems that research shows that a disk crashed and was recovered on the 10th of July, 1973. This was the same day that Williams and Smith were flown from Hawaii to Norton to conduct their photography. Could these aliens and the disk be the very one that crashed in Northwestern Arizona?

That's a good question. The story is not over. After interviewing Williams, we discussed regression attempts that might have been made after their experience. Yes, Williams had had one done, and it came out during the regression that he and Smith were not in the car all the time during their trip to Norton. At one point during the trip, both men had left the car and had been put aboard a disk. He remembered seeing the ground move away. The point at which the disk left the Earth was later established as Blue Diamond, Nevada. There was a female human aboard the ship. We'll get back to that, but first let me tell you a little more about Williams.

Since the age of 3, Williams has experienced what must be presumed to be out of body experiences where he visits Earth's future in what is apparently 2050 AD. Williams says that when he is there it is just as real as being here. People live in buildings that house over 600 family units. White buildings. THE BUILDINGS ARE BIGGER ON THE INSIDE THAN ON THE OUTSIDE. Ever since the age of 3, he has known this girl there named Karin. Over the last 20 years or so, they have become

quite close. They have physical experience together, such as eating, making love, etc. They have a perfectly happy relationship. Karin was the same girl that was one the ship the day Williams and Smith were taken to Norton to do their photographic work.

I might add that it seemed to Williams that he became more mentally acute after the experience at 29 Palms. Nine months later his wife gave birth to a girl who later proved to be a child prodigy. She is more than 15 years old now and going to college. Williams feels that some physical changes occurred when the alien looked at him as he slipped out of his body and died. What Williams felt was so strong it made him drop his camera.

Investigations of the 29 Palms underground base during April 1989 tracked down some data about the geology of the spot. During the time when the area was under the sea, an earthquake caused a large hole in the ground, causing a lot of water to create a funnel-like structure in the ground. Evidently, disks go in and out of there all the time, and the Army has tried to send cameras down there, only to have the cables cut. One group of men that attempted to go down on ropes were exposed to a blue gas and had to be pulled out again. Perhaps we'll hear more on this very soon.

Notes

TWENTY NINE PALMS FACILITY

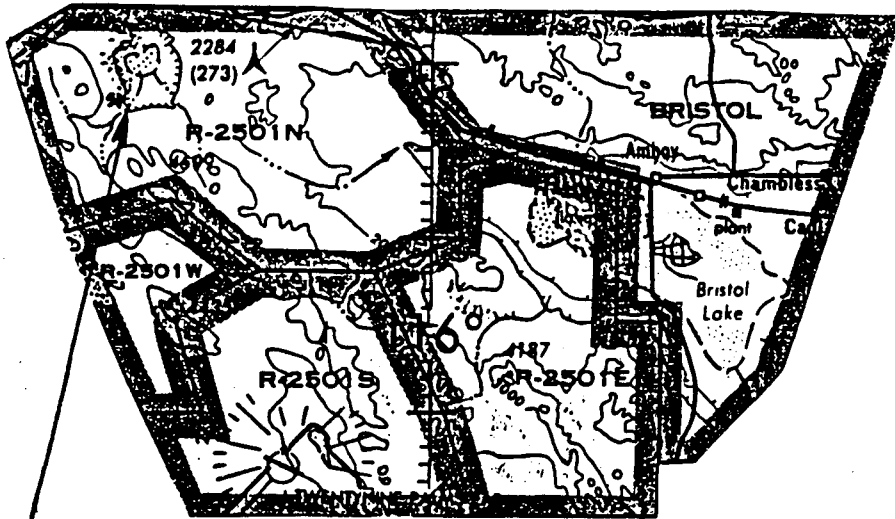

United States Alien Research/ Diagnostic Facility

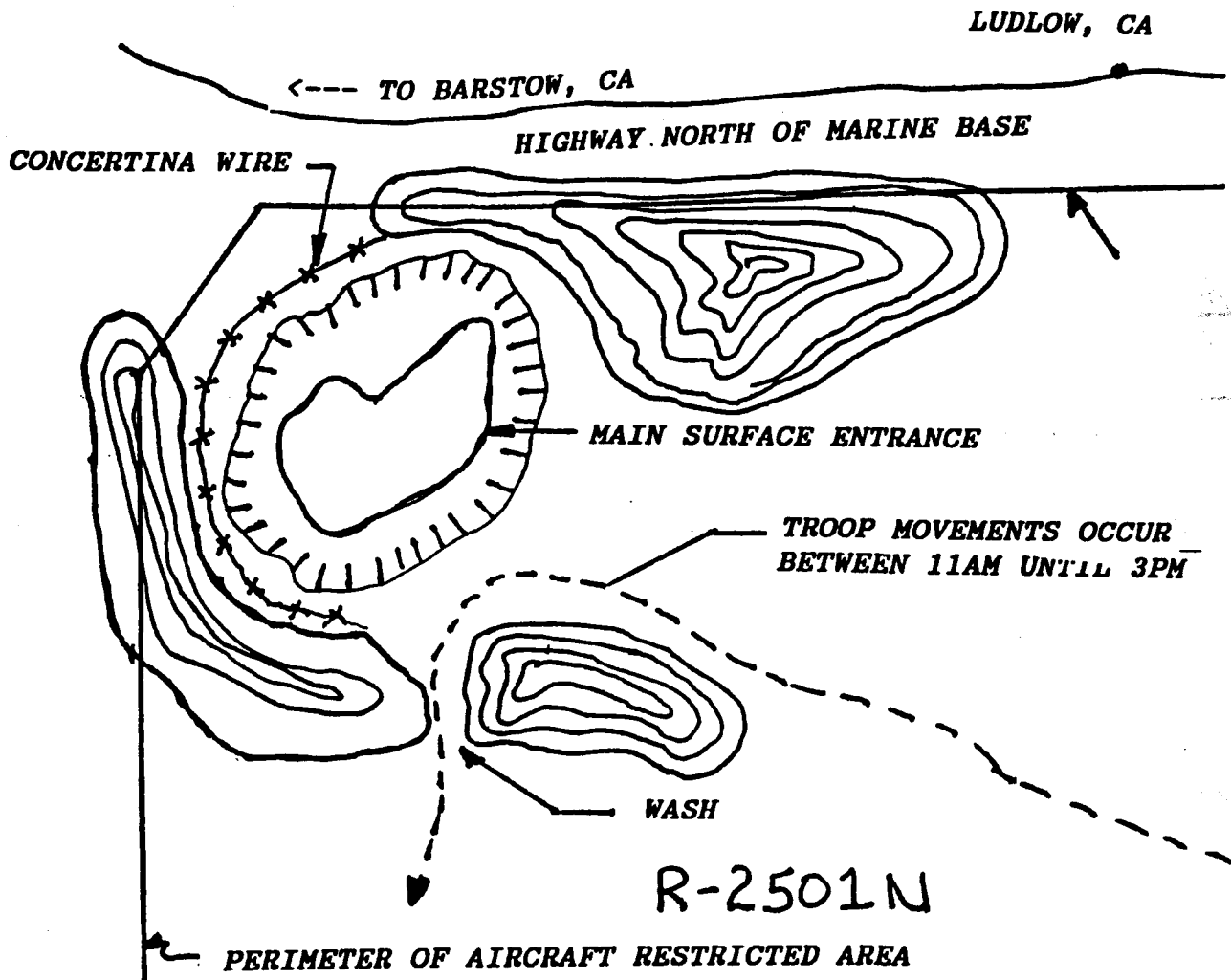

PINE GAP UNDERGROUND SPACE CENTER

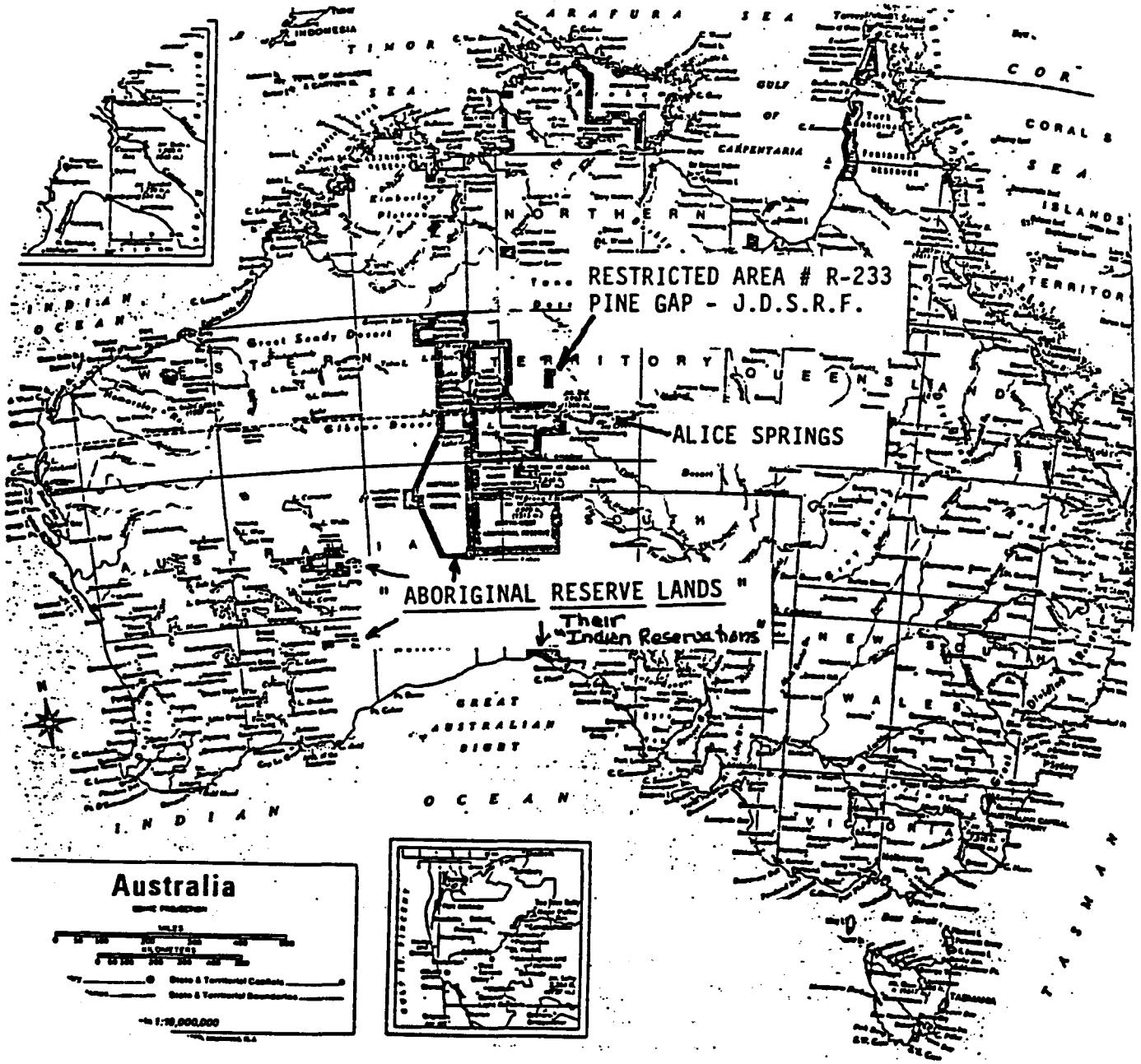

WAR OF THE CAVERNS

BY TOM LUCAS

If the importance of the caverns beneath Siloam Springs and Eureka Springs is a bone of contention between the picturesque little towns, Hot Springs, Arkansas, would be the next logical choice for investigation. During the 1930 Prohibition days, it was frequently reported in a Chicago newspaper that Chicago gangsters traveled often to Hot Springs to go to the horse races and soak in the hot baths. It seems reasonable, based on what we think we know now, that during lulls in recreational activities in Hot Springs, leaders of the various gangs made discrete trips to the caverns beneath the city to brag about their latest exploits and to bring offerings of gold.

To get a rough idea of what a cavern map of the U.S. would look like, simply pull out a road map of any state and identify all of the dense population centers, be they cities or hamlets. Where there is a city on the surface of earth, there is a city in the caverns below that city... "as above, so below." The co-relation breaks down as the size of the population centers dwindle.

If there is another city beneath Chicago, why were these Chicago hoodlums marketing illegal alcohol traveling to Hot Springs to visit particular caverns there? In the early 1930's, the caverns of Hot Springs must have been the U.S. capital, or at least a regional area, for the marketers of illegal alcohol.

Cavern communities close to the surface are probably not completely self-supporting and require huge injections of funds to keep them going. These facilities lack the super-technologies of those caverns much deeper in the earth, and require much gold for trading with people within cities deeper in Earth's crust. An ounce of gold in the underworld has much greater buying power than on the surface because the deeper super-productive cities need all the gold they can get and are willing to make generous trades for gold. This relieves the near-surface caverns of the burden of secreting goods and services from the surface world which would be a real security headache.

Cities beneath cities, and some hamlets, require injections of wealth from the surface that doesn't leave paper trails to their caverns. Each cavern has to develop and specialize in some particular money-making scam, or any number of string embezzlements to bring in a constant stream of traceless cash and gold.

One cavern, for example, specializes in addictive drug sales, another bank embezzlement and fraud, another stock market riggings, government money transfer schemes, along with other more esoteric and less known ways of generating profit that must eventually be converted to cash and gold that cannot be traced. The expression underground cash economy is probably a semi-cryptic phrase that refers directly to installations beneath cities notorious for dealing only in cash and gold.

When America was young, developing underground caverns beneath American cities having a flavor of anarchy similar to communities developing on the surface, did not at the time have formal relations with each other...not even "wild west" sub-surface communities in the American West... "as above, so below."

Over a period of time, cavern communities within regional areas geographically near each other found they had to get along with each other in a non-competitive manner, to encourage synergetic relationships which tended to raise the standard of living of each of the involved cavern communities. Each cavern specialized in an area of crime-monopoly expertise that wasn't in competition with neighboring caverns. If a regional area demonstrated it could keep surface dwellers above in line - e.g., keep them thinking the right thoughts, stifling all real creativity, via the under-ground's crack people-management teams and organizations on the surface in the form of police departments, public schools, controlling secret societies, quack medical fraternities, polished propogandists and moralists, a sufficiently initiated clergy, etcetera - then this regional area is allowed to incorporate into a semi-autonomous fiefdom that would eventually reflect on the surface as "a county" in the U.S... "As above, so below."

These underground fiefdoms in the form of counties then combine to form states; states combine to form the nation... Today, 33 degree Masonry and the higher degree (33+) is getting ready for the final conflict between Rightwing Caverns (RWC) and Leftwing Caverns (LWC). This conflict will not be so much a battle between countries on the surface as it will a war

of the caverns. Surface 33+ is clandestinely developing relatively unknown caverns beneath smaller communities which 33+ confidently feels will not be identified and destroyed once the conflict begins. Surface 32 degree and below are to be left on the surface to die with the rest of the profane. The deal is, knowing a real holocaust is coming, 33+ is planning to abandon the old underground installations and flee to the new when the time arrives. It appears that both left and rightwing factions will be responsible for the sacrifice of huge segments of Earth's above and below ground populations.

At the same time underground 33+ develops remote survival caverns - an activity generally unknown to underground inhabitants, including 32-, they are also developing caverns without support communities which, above, could pinpoint their survival caverns for target purposes... Without support communities to obscure their activities, surface M's are deprived of this advantage.

When one moves to a cavern without a support community above, it is similar to a surface dweller moving from the city to the countryside. Unless there is access to needed goods and services available at alien facilities much deeper in the earth, each time the remote cavern dweller needs something from the store he has to travel to a cavern with a support community above to get what is wanted.

While in the Navy, I was told that only five men, who were sworn to secrecy, decided the targets for America's bombs; also that these five men were the only ones who knew where the bombs were going! This means targeting information inside the ICBM's are sealed and not even technicians loading the programs know what is on them. Bombing instructions for nuclear bomber pilots are sealed. This means submarine captains do not know where their ICBM's are headed. All the captain does is tell the missile its location and the missile decides where to go. Apparently an almost unlimited number of possible target guidance programs are generated and placed in a library made available to these five men. To be installed in missiles appropriate for specific targets, all is sealed and safely locked away.

I'm sure the method by which all this is done is complex and thought out in a way understood by none other than the five select men. I doubt the system has changed since my Navy days of years ago. The activities of these men and the targets selected are never audited. The person who told me this said there is no way of ascertaining if these five men are even on our side! Though the faces of the men may change over the years, the system of security remains the same. These five men must all be M's, which means there is such room for mischief.

300 U.S. citizens were made ready for the 1917 Russian Revolution. Taught the Russian language and leftwing socialist ideology, they were shipped off to Russia to form the first politburo. Plainly, this means that socialist Russia is a tool and puppet state of the United States. Any recent reforms in Russia will not change the fact that she is still taking orders from the U.S. Although the front men may change, leftwing socialists are very adept at making reforms that increase their power.

All of which indicates that it is unlikely that the bulk of America's atomic arsenal is aimed at Russia, as claimed and, for the most part, it is unlikely that Russia's atomic arsenal is aimed at the United States. The only missiles targeted for the U.S. would be aimed at the underground installations of the most lethal of rightwing adversaries...After all, the effectiveness of our underground nuclear bomb-testing program is just that...a test showing just how efficiently each bomb design destroys underground caverns!

As for our nuclear submarine fleet plying the waters off Russia day and night, ready to attack at a moments notice, there is no proof of that. Our subs could be anywhere, and perhaps are. Submarine movements are top secret.

Summarizing, it appears that both Russian and American nuclear arsenals stand ready to fire in concert. But at what? The answer is all caverns which, occupied by the enemy of World War II, are awaiting the time to deliver their nuclear missiles from sanctuaries beneath the Antarctic, and from cavern strongholds beneath South, Central and, perhaps, North America.

This explains why the U.S. and Russia have such a large surplus of atomic bombs. Caverns tend to be nuclear bomb proof, except for direct hits which means that at least one bomb is needed per cavern, and perhaps several just in case the first one fails to make it. All these bombs going off will have a negative environmental impact on all life on the surface; but the 33+ plan to be safe and snug in their holes.

Both sides could fire all their arsenals at once; but this is unlikely to happen. World War III will be protracted and both sides will agree to a standard set of rules for the war.

As the war progresses and the world's standard of living drops, squabbles over remaining resources will become frequent, and pointed. States will fight states, counties will fight counties, towns will fight towns, all of which will reflect the political biases and inclinations of controlling caverns beneath.

Did you know that only group organisms such as ant hills and termite colonies - and masonic controlled man - indulge in mass warfare? Nothing else in nature does.

All group organisms, such as bee hives, use sex odors (via the queen bee) to induce conformity in the hive or colony. Masonry is most similar to the termite colony in that both chew away at the foundations of civilization and neither can stand the light of day.

Masonry may not use sex odors to induce conformity and absorption into the group organism but it does use mesmerizing, hypnotic rays that may have a sexual content to it. Selfless devotion to service, faceless anonymity, slavish devotion to a noble ideal...for the good of the whole, work without compensation, profitless causes, these are the value-philosophical ideals of an ant in an ant hill, a termite in a termite colony...and a mason in the masonic organism.

Interesting is how cleverly encyclopedias talk about springs but never caverns, and that De Sota was more curious about caverns than springs. The tunnels I recently learned of that lead off from basement rooms in the old Knights of Pythias Temple in Springfield, Missouri, which is in the heart of the Ozarks, gives pause for a lot of wonder and conjecture. Until recently, I thought only a few surface dwellers knew and had access to the Underworld, but it now appears to be common knowledge among those of a specific segment of the population... It's just that those who talk don't live long.

On the Current State of Surveillance Technology and Technical Developments Outside of Public Knowledge

Navy Technology

It is well known by avid researchers that the US Navy has been involved with contact with advanced technology since the early 1930's.

The experiments in oblate spheroid magnetic fields in the Philadelphia shipyard in the 1940's was a good indication of how far experimentation was proceeding, even in those early years.

Last year, it was revealed that some of the disks which flew in California in 1968 belonged to the US Navy. These disks flew around the China Lake area and had three spherical field projectors on the bottom.

Even in 1989, when Robert Lazar brought forth his employment at the Nevada Test Site, Site S-4, it was revealed that the Navy was the primary source of paychecks. It was also learned that EG&G and other companies were involved in disk technology, back-engineering, and other developments far beyond what is commonly seen by the public.

Air Force Technology

It is pretty clear now that there is a long lag between development, production and testing of advanced aircraft and their potential public appearance. The SR-71 was first developed in the early 1960's but didn't "appear" publically until many years later. The B-2 bomber is rumored to have some alien technology incorporated into its workings. A year or two ago, an engineer from Lockheed hinted at developments when he said that "they have things on the Nevada Test Site that would make George Lucas drool". All advanced air vehicles are manufactured in coordination with General Electric, Boeing, Lockheed, McDonald Douglas, Northrup and other corporate military industrial complexes in underground "skunk works", such as those in the Tehachapi mountains in California and other less publicized sites.

Some Advanced Technical Developments

After several years of research and the cooperation of many individuals, some ex-NSA security and CIA, it has become apparent that most people have a big shock in store for them:

- (1) A former Navy man recently admitted that he was part of a test in the 1960's that involved the holographic projection of another man, in motion, into a chair beside him. The test was whether he could tell the difference. He couldn't.
- (2) It is apparent that part of the government has technology that makes it possible for them to perform surveillance with disk shaped gravity powered craft, three to six feet in diameter, that are remotely piloted vehicles (RPV's). These craft have been built using alien technology. They have the capability to cloak themselves into invisibility while doing surveillance activity.
 - (a) The method of surveillance involves projection of a high frequency radiation that will penetrate walls ceilings and the earth and reflection of that energy back to devices that involve phase conjugate optics (to correct for atmospheric distortion). The energy reflected is then passed through a system described as an optical heterodyne which channels the energy into a visual imagery system. In other words, they have the ability to see through walls and take a look at you any time they want.
- (3) During the 1950's, a series of experiments sponsored by the Central Intelligence Agency and the NSA, called the "talking rock experiments", eventually progressed to where now they can retrieve not only audio signals from the "past", but also visual images. In other words, they can now video-tape you in your home doing something specific - they can tape you now - two weeks later they can still video tape the same conversation. There is a lot of evidence that the government has been involved in experiments with time shifted magnetic fields. The Philadelphia experiments were only the beginning.

(4) Several years ago, a fellow researcher was acquainted with a former Air Force warrant officer (who later committed suicide) who used to fly a YF-12 aircraft in the Pacific. At one point he encountered a teardrop-shaped craft during a flight. Later in his career, he became involved in highly classified technical work. Before he became despondent enough to commit suicide, he revealed the following:

- (a) In 1969, there were 60 B58 Hustler aircraft kept in an underground base that had an underground runway which ended in an opening to the surface. Each of these 60 aircraft carried a cobalt bomb strapped to the bottom of it.
- (b) In 1971, there were tests being conducted of a Gamma-ray laser (GASER) that would track and shoot down meteorites.
- (c) Also in the early 1970's, this same Air Force officer was stationed at a secret base in Wyoming. The base security was so high that entry to areas was by both photo and voice print analysis. An experiment was done there that probably counts as one of the most totally irresponsible acts performed by the US government.

Experiments were being done again on time-shifted magnetic fields. Remember that they have been working with this and elements of alien technology for decades. The experiment involved the actual detonation of a nuclear device inside a time-shifted magnetic field to see if any of the energy escaped the field. None did. In other words, these people deliberately sent the entire force of a nuclear explosion into time. No one knows where it went.

One can imagine the potential damage that was created on the other side. It is possible that this act attracted other alien species wishing to understand who would do such a thing, and this act might have been responsible for the premeditated disruption of other beings.

THE STORY OF GARY STOLLMAN

On August 19, 1987, Gary Stollman walked into KNBC Channel 4 television studio. His father, Max Stollman, was a reporter for the station. The following day, the newspapers reported the following:

BUREBANK, Calif (UPI) - A man who talked his way into a television studio pulled out what appeared to be a handgun during a live newscast Wednesday and forced consumer reporter David Horowitz to read a rambling "nonsensical" statement about space creatures and the CIA....

Actually, Horowitz never read the statement over the air, for the station went to a commercial and blacked out the statement. When it was over and Gary handed over his unloaded BB gun, he was taken into custody. We obtained the statement from NBC 24 hours later. It refers to many things which ring true when bumped against other facts that are appearing in regard to EBEs and the intelligence community. Here, for your information, is the text of Gary's statement:

"The man who has appeared on KNBC for the last 3 years is not my biological father. He is a clone, a double created by the Central Intelligence Agency and alien forces. It is only a small part of a greater plot, to over throw the United States Government, and possibly the human race itself. The CIA has replaced and tried to destroy my family, and those of my friends.

Although I have known about this since 1981, I have not taken any action about it for fear of the lives of my family. I have been forced into CIA-run mental hospitals, such as Cedars-Sinai Thaliens, where I am shown being interviewed by many different doctors, although I spoke to nobody there for two weeks. At UCLA-NPI, I attempted to have myself released by a court several times, but was asked by a Dr. Martin Zsuba to keep removing my requests for a writ-hearing. I have been unable to obtain records from several other hospitals, including Ben Taub Hospital in Cincinnati, where all the phones were turned off for 48 hours after I arrived.

I do not know where my real family or others are being held, but I believe it is somewhere in California. The records for Ben Taub Hospital, I have been informed, no longer exist, or have been misplaced.



"I heard an interview a few weeks ago, on radio station KPFK, in which a former CIA official told a college audience in San Diego how the CIA has towed barges filled with diseases across New York harbor, placed lightbulbs in the subways to create vertigo, and cameras to observe the reactions, and may have created the AIDS virus to wipe out the gay population.

He also spoke of secret teams that were created after World War II. I say that the CIA assassinated John F. Kennedy and the 22 material witnesses that day, who all died within 2 years of each other, a mathematical impossibility. What they are capable of, I know only too well. I demand the public release of all secret Air Force files concerning UFOs, which were kept secret even from Senator Barry Goldwater. On my way back from Expo 86 last year, I heard a broadcast in Oregon that (said that) he once asked to see the files, and was told, "Hell, no!". I demand the release of information concerning the objects contained in Hangar 18 at Wright -Patterson Air Force Base, now obscurely referred to as the Environmental Control Building, the most highly guarded building in the world. Why has the knowledge of such advanced beings and equipment been kept so secret that even the United States Congress does not know?

I would have been satisfied to let my situation stand if it were only I and my family who were at stake here. However, I spoke to a girl at Florida Junior College two summers ago, who related the story to me of how 7 of her friends had also been replaced. She said that she had written absense excuses for them when they weren't sick, then they disappeared for a week, only to come back with different personalities. Unless we act swiftly, there may not be very much hope for any of us. These people, or whatever they are, are taking over the phone services right now. The CIA is either doing this themselves, or are helping them.

I was warned in 1981 by someone with connections to the CIA to stay off computers, that they didn't trust people on computers. Then I began receiving disturbing calls from my parents, which led me to believe that something terrible was going on. I was forced into a mental hospital in Tallahassee, where I learned that my brother in law had been driven insane in the same manner that someone was trying to do to me. I eventually was released, but then my mom came down to visit me and I knew it was an imposter. I know that the secret service is involved in this as well, so who knows just how far this has gone in 5 years.

" I know of a counselor named Pat, who worked at the Optimist Boys School near Pasadena, who was involved in recruiting members for some secret group of people. Apparently, they adopted orphans and gave them fake ID's and birth certificates. Since we already know of a secret group led by the President's own staff, someone had better find out what is going on and fast. I only know that there are beings around us now with the power to teleport instantaneously and do the same to others, who can read and control minds, and transform matter into other forms or create it at will.

I ask for a Congressional Investigation and Federal protection for my family, and those involved.

There is no way I can harm anyone with an empty BB gun. "

Well, there you have it. Quite a statement. Buried within the statement, however, are references to things that we've heard before, aren't there? An attempt was made to contact Gary Stollman's lawyer, but after the lawyer perceived that we thought that some of what Gary said could be true, he disappeared himself. The last known location of his lawyer was in Los Angeles.

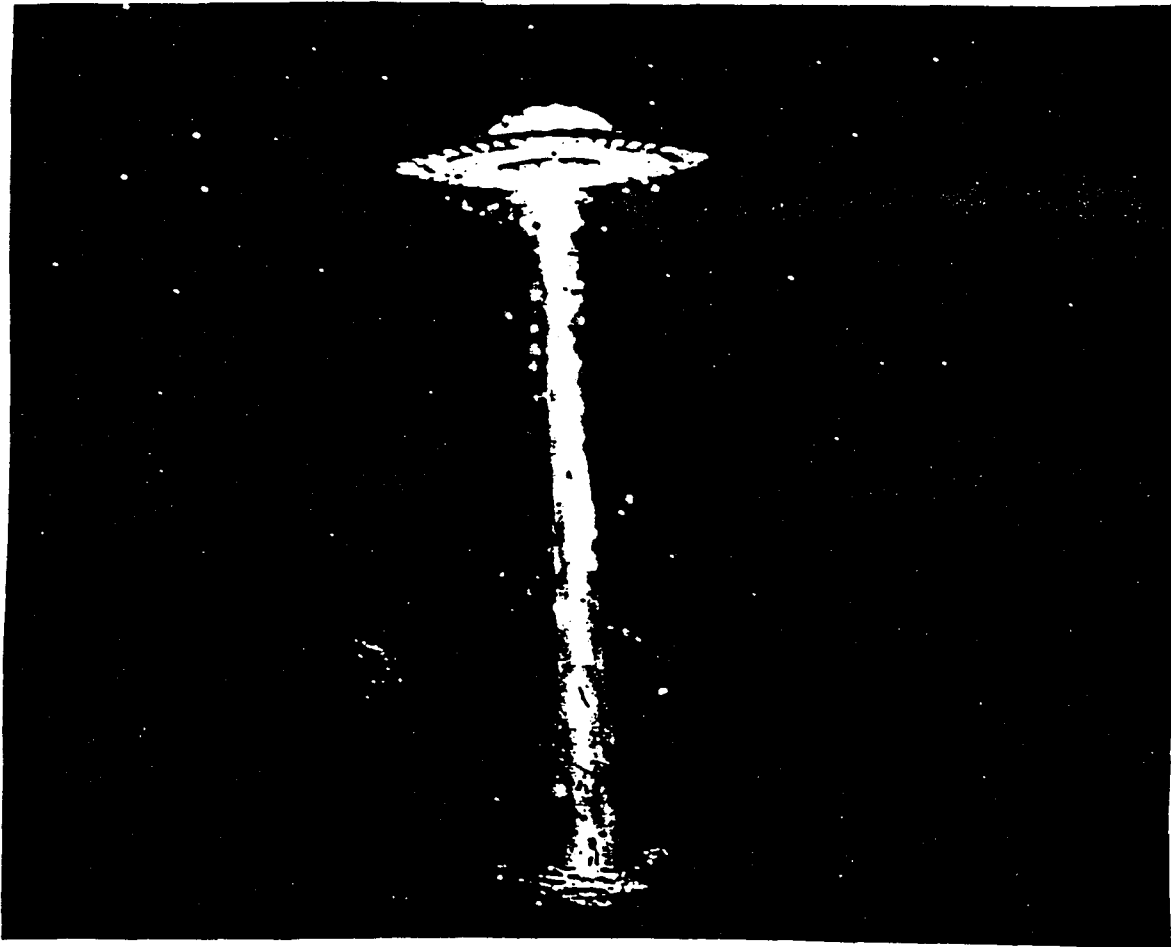

MIND CONTROL EFFORTS IN THE UNITED STATES AND THE CRYPTOCRACY OF CONTROL

Acquisition of mind control and thought beam technology from non-human sources is the final act in a long series of events that started many years ago. The purpose of mind control, as far as the United States Government is concerned, is to devise operational techniques to disturb the memory, to discredit people through aberrant behavior, to alter sex patterns, to elicit information, and to create emotional dependence. The goal of mind control is to program individuals to carry out any mission of espionage or assassination even against their will...even against such fundamental laws of nature as self-preservation...and to control the absolute behavior and thought patterns of individuals.

In this era of psychopolitics, the guise of National Security is used as an excuse for illegal activities, a cover for unsanctioned deeds, and as an instrument of manipulation of public opinion and individual citizens. Mind Control plays a vital part in this whole scenario. The primary target of National Security has been the people of the United States, since a secret government cannot exist in a climate of free speech, open criticism and public exposure.

The Myth of National Security

The great root of war is the vulnerability of the public to manipulation on national security issues. People do not perceive where their true interests lie and hence are easily swayed by emotional appeals to support policies that cost them their money, their sons, and their own lives. Because they have been willing to accept uncritically the myth of national interest-i.e., the definition advanced by the national security managers - they exercise almost no control over the commitments the managers make in their name. Constitutional protections that existed were effective until they were circumvented by the technological revolution and the National Security Act of 1947.

Drug Related Projects

Most of the drug related mind control projects were done under the direction of the CIA and under the operating authority of the United States Navy. At Bethesda Naval Hospital, under the direction of Dr. Gaefsky, the drug project that began in 1947 continued until 1972. CIA reports defined the projects at Bethesda as ones which sought to isolate and synthesize pure drugs for use in effecting psychological entry and control of the individual. One remembers when James Forrestal jumped backwards out of a 16th story window at Bethesda shortly after he became overly interested in the handling of UFO and alien related matters within internal circles. Project Bluebird (funny how things having to do with UFOs/aliens start with "blue") was the initial designation for drug related projects.

As electronics began to develop, other kinds of mind control projects began to take shape, especially under the new project name, Project Artichoke.

The Age-old cry of the Oppressor: "A Matter of Internal Security"

RHIC-EDOM File

The RHIC-EDOM file was a 350-page document prepared by the CIA immediately after the murder of JFK. The report described a way of turning men into electronically controlled robots that were programmed to kill on demand. In the RHIC phase, the individual was put into a trance and given suggestions that were activated in one or more levels by key words or tones. In the EDOM phase, which was an acronym for Electronic Dissolution of Memory, the memory of the individual was affected to either eliminate or alter the memory of events that the individual was involved in. By electronically jamming the brain, the existing acetylcholine creates static which blocks both sights and sound. This method can be used to either block/erase the memory, or to slow it down so that events seem to happen after they actually have occurred.

Biological Radio Effects

The use of Very Low Frequency Sound or Ultrasonics has been well documented. VLF sound and Ultrasonics can affect both the electrical behavior within the brain and the actual brain tissue.

In the current phase of international VLF warfare, pulses of 7-12 Hz are bounced off the 8 Hz ionospheric envelope around the earth. Within these pulses are entrained bizarre and aberrant patterns that produce equivalent behavior in humans. In both California and Washington state there are extensive problems with the results of this type of activity.

In 1961, the University of Illinois did experiments on ultrasonic research that eventually got into the hands of the military industrial complex.

Other Ultrasonics Research

The experiments done in 1961 by Drs. W.Fry and R. Meyers used focused ultrasonics to make brain lesions of a controlled size. Their research demonstrated the advantage of ultrasonics over psychosurgical techniques which implanted electrodes in the brain.

In 1963, Dr. Peter Lindstrom at the University of Pittsburgh used a single unfocused sonic beam to destroy fiber tracts in the brain without damaging the nerve cells next to them. This pre-frontal sonic treatment replaced lobotomy.

Early Projects

As detailed in the documents section having to do with mind control, early experiments were termed Project MKULTRA, which had to do with the research and development of mind control. Project MKDELTA began the operational phase, during which techniques of mind control were applied to individuals. This process is still occurring today, only it is even more sophisticated and damaging.

Some of the High Points in Development of Mind Control

A research and development team at the Space and Biology laboratory of the University of California at the Los Angeles Brain Research Institute found a way to stimulate the brain by creating an electrical field completely outside the head. Dr. W. Ross Adey stimulated the brain with electric pulse levels which were far below those thought to be effectual in the old implanting technique. Ten years before, Dr. Delgado described a society kept under control by electronic brain manipulation. By the late 1960's, remote control of the brain was well on its way to being realized.

In 1975, a primitive "mind-reading machine" was tested at the Stanford Research Institute. The machine monitored silent thoughts. The machine was the creation of psychologist Lawrence Pinneo and computer experts Daniel Wolf and David Hall. Their originally stated goal was to put a computer programmer into direct contact with a computer. The concept promised benefits for the physically handicapped, but as with everything new the military applications came quickly into view.

In 1976, a young scientist at the Rockefeller University named Dr. Adam Reed made another conceptual proposal. He said that "by 1996 it will be feasible to encode and transmit brain waves from a small device implanted inside the skull. This development promised transmission of data from computers directly into the brain, which parallels the processes (according to channeled sources) that some of the alien groups use in their inculcation (forced learning) process that they impose on androids or humanoids that they use as workers. This process was eventually worked out and made the way clear for the development of RHIC-EDOM (Radio Hypnotic Intra-Cerebral Control - Electronic Dissolution of Memory) and allied applications.

Intelligence forces have already developed remote controlled men who have no memory of their programming, but will perform a pre-assigned task when exposed to an audio or visual cue. These men, who are essentially cyborgs (altered and controlled humans), are far less expensive than robots. They are also expendable. There is now sufficient evidence to indicate that the assassinations of John and Robert Kennedy, as well as Martin L. King, were carried out by individuals who were programmed with RHIC-EDOM techniques by intelligence forces.

The court system, in all but a few cases, has retained the position that criminal behavior cannot be induced under hypnotic methods. If the intelligence forces in the United States and elsewhere stand outside the law that applies to the rest of us, then it doesn't take a lot of imagination to see where events will lead if we are not vigilant.

To review the labyrinth of events: Out of the natural fear of technology grew an unnatural reliance on security. Secrecy led to covert control and produced a well-organized institution of "national security" that would function as an umbrella for all activities outside the law. Institutionalized secrecy directed covert research and produced Operation Mind Control, the ultimate technology of secrecy and control — next to what is being thrust on the human species by alien forces impinging on our planet. One can easily see how thought-beam technology and implantation of biological monitoring and control devices fits nicely into the plan.

A FORMER pilot closely linked to the CIA charges the agency tried to force him to do its bidding — by stealing his brain.

It was all part of a diabolical plot by the powerful government agency to take over the world, charges James Petit, 39.

The adventurer and soldier of fortune says that he has lived a chilling real-life version of the movie *The Manchurian Candidate* — in which a man is turned into a mindless robot who instantly obeys all orders and kills on command.

Chinese

But while the Red Chinese in the 1962 film used brainwashing and torture to create their puppet, Petit claims the CIA made a robot out of him by inserting receivers in his brain.

Petit is currently serving a jail sentence in Miami on an arson charge — which he says was set up by a CIA agent who posed as his girlfriend after he threatened to blow the whistle on the top-secret operation.

An admitted drug pilot and arms smuggler, Petit had trouble getting anyone to believe his incredible story — until court-ordered X-rays of his skull revealed a strange, bottle-shaped object.

Implants

"The quartz implants are like little radio receivers," declared Petit, a Texan.

"I think the CIA was going to use me in a program to assassinate someone."

Confirmed his lawyer, Roy Gelber:

"There are definitely foreign objects behind his left ear near the neck which radiologists conclude have no physical reason for being there."

Petit's bizarre story began in April, 1982. It was then that Petit — known as "burn 'em" by federal

drug agents because of the many planes he crashed during his brief career as a drug pilot — went down in the Columbian jungle with a companion.

The aircraft ran out of gas, crashed, and exploded in a pasture. Petit claims it was sabotage.

"I was burned over 65% of my body," he says. "We hiked through the jungle to a small town, where we were patched up."

Amazingly, even though they were in the middle of nowhere, his girlfriend — who Petit later accused of being a CIA plant — suddenly turned up.

Disfigured

"When I left her in Miami she had no money, no passport, yet here she was," Petit recalled.

He was horribly disfigured, with his nose charred away and the fingers of his right hand burned off at the knuckles. His sweet-heart, he says, arranged for him to be taken to the burn center at the U.S. Army Institute of Surgical

Research in San Antonio, Texas.

Hospital spokesman Ray Dery confirmed that Petit was treated there until July 2, 1982.

Petit insists that it was while he was a patient there that doctors placed the implants in his neck, face, arms, and ears — and he saw them do it.

Three times during the surgery, "I left my body and watched the operation," he declared.

Doctor

"I have the power of astral projection. I can leave my body.

"I saw this doctor working on my ear — with a drill in his hand, like you would drill a tooth with."

When he asked another doctor why he was putting wires in his arm with a long needle, "he got red and blurted out it was only antibiotics," Petit said.

"But they were wire implants.

"After my release from the hospital, I was having such extreme pain it was unbelievable. It was directly due to the CIA transmitters."

Petit claims the whole

● I think the CIA was going to use me to assassinate someone ●

episode was part of a bizarre CIA program called Operation Crystal Ball designed to take over the world's judicial and political systems through mind control by the year 2000.

Petit says he found top secret documents carrying details of the program in a

dumpster in Key West, Florida, about 20 years ago.

And, he charges, he's by far the only man surgically tampered with by the CIA.

"It would be a good idea to check Sirhan Sirhan, the man who shot Robert Kennedy, to see if he has implants," says Petit.

"James Earl Ray (who killed Martin Luther King) and John Hinckley (who shot President Reagan) should be checked too."

Confirmed

Kathy Hamilton, Petit's former attorney, has been quoted as saying he definitely worked for the CIA.

"That has been confirmed," she said in an interview.

And attorney Alexander Martone, representing a co-defendant in a federal drug case, added: "I have direct confirmation that Jim Petit has flown for the CIA."



X-RAY shows bottle-shaped object behind his left ear.



NATIONAL EXAMINER 4-30-85

Former drug pilot says Operation Crystal Ball is plot to take over the world

By JIM LEGGETT

Military Uses of the Electromagnetic Spectrum

The whole command, control and communications ability of the military complex is based on usage of the electromagnetic range of frequencies ranging from extremely low frequencies (ELF, which includes frequencies near or at those already occupied by human brain waves) to super high frequency microwaves. The doctrine of electromagnetic (EM) frequency use by the military began (at least as far as the public was concerned) with the use of radar and EM communications. During the period of the Vietnam war, exotic equipment for communications and sensing became apparent. Vietnam is considered by many as the first EM war, as satellite relay systems were used with ground equipment.

The only apparent restriction ever publicly placed on use of the EM spectrum was the "safe exposure standard" as applied to microwave frequencies in the 1950's. The research into what "safe" levels meant always referred to thermal effects on living organisms, never the direct EM effects. In fact, research done on direct EM effects was covert and never discussed. In the 1970's it became apparent that the Soviets were doing extensive research on EM effects with living organisms. While the "safe standard" was limited to microwaves, the concept of "discuss thermal effects only" was generally extended to all EM frequencies. Any research done on direct EM effects on humans was suppressed, and researchers who made efforts to publish results of such research were often discredited.

Since the military complex perceived that it had to be defended against non-thermal bioeffects, evidence for non-thermal effects was deemed a "threat to national security". This led to the direct policy of denial of non-thermal effects from any EM source. In order to accomplish this policy objective, specific actions were taken by the military:

- a. Control over the scientific establishment through selective fund allocation to discourage projects addressing non-thermal biological damage.
- b. Formal mobilization of the scientific establishments of the United States to publish voluminous reports discrediting any research in these areas, as well as extensive disinformation campaigns. This included "expert" testimony as well as public discrediting of scientists who raised these issues.

After some time, the weight of evidence and the problem of suppression of knowledge forced the government to admit to some "limited" non-thermal effects, with various "ongoing studies" being initiated in order to obscure actual facts as far as the

public was concerned. One of the reasons for the obfuscation of these effects was the perception that there was a long lead time necessary for development of EM weaponry. At present, deployment and use of exotic EM systems continues without any regard to the effect on the health and welfare of human beings. Access to alien technology, specifically advances in EM mind control and implant technology, have only compounded the problem. Electromagnetic pulse (EMP) weaponry research has also contributed to the development of weaponry that does not need a nuclear explosion to generate EMP. This research has contributed to the development of high-power pulsed microwave weapons which range in frequency from 1200 MHZ to 35 GHZ with power ranges exceeding 1000 MW. It is known that microwave frequencies in the range of 1 to 5 GHZ will penetrate all organs of the body and put the function of the body at extreme risk, with marked effects on the central nervous system.

Testing programs along this line began in earnest in 1986 and focussed on four main areas:

- a. Immediate debilitation of the human organism.
- b. Stimulation through auditory effects.
- c. Effects directed at interference with activity.
- d. Effects directed at behavioral control.

High-powered microwaves achieve or exceed the results noted by Delgado in his original research on mind control. ELF weapons have the capability to interfere with every aspect of the human organism. With this technology, the military has the power to essentially control the minds of the population. It is an established fact that the military believes that its survival is worth the lives and health of large segments of the American population.

As mentioned in Matrix I, microwaves have the added ability of being able to erase memory functions in the human.

Some Components of Mind Control

Robert Lifton discerned eight criteria involved in mind control activities. The basic principle is one of 'ideological totalitarianism', which is the end state achieved through what has been described above as story immersion process of 'brainwashing'.

The criteria include:

1. **Milieu control:** towards total control of the target subjects environment, setting and 'world' of possible perception and experience. The 'milieu control' is essentially the environmental level descriptive for 'story immersion'.

2. **Mystical manipulation:** also known as 'planned spontaneity', when rigged: this is the process of making certain experiences occur for the target subject, which experiences cannot be explained in any logical 'linear' terms of the environment the subject originates from, that is, lead to conclusions of something happening that is beyond the 'normal', worldly, and common sense. These are events that are intended to be readily explainable by the subject except in general "this is beyond my understanding", and yet are explainable in terms of the new target beliefs being indoctrinated.

3. **Demand for purity:** in the sense of purity as defined as those behaviors, those personal states of 'being' and 'doing' that are considered in 'alignment', acceptable, and appropriate within the context of the target beliefs and 'sacred' milieu. 'purity' is used as a dualistic metaphor to imply that anything in the target subject that is not in complete agreement with the target belief and 'sacred' milieu, is impure, of no worth, a liability, and cause for 'rejection'.

To be impure is to be unworthy or polluted or unsuitable or lacking, and therefore anything that is evoked in the target subject that originates from their original beliefs which in any way oppose or diverge from the target belief. 'Purity' is often used by implication to provide a catch all for any beliefs or feelings or activity on the part of the target subject that are not within the target belief. Hence, the target subject's non-aligned experiences are subordinated into a ready made 'slot' of the 'impure'.

4. **Cult of confession:** this serves several purposes: a) to provide a means for the target subject to 'release valve' or 'purge' those non-aligned experiences and behaviors which are in conflict with the target belief system, b) to provide a means for information collection about target subjects, in essence, an intelligence gathering activity, which can help to identify problem subjects and threats, and c) to provide a target belief 'wrapper' or 'interface' or 'probational reinstatement' process that occurs immediately before and especially after the expression of 'impurities' by the target subject.

5. **Sacred science:** the use of frames of reference that are respected by the target subject and common to their sense of 'consensus reality' from which they originate. It is images of 'god' that can fit into a high technology worshipping society. The use of science frames to reinforce mystical frames is often an effective means to gain subsumption of the target subject's most powerful source of counterbelief, that is, the consensus reality pillars of objectivity need to be covertly subordinated to the mystical target beliefs, and so what better way than to develop a means to ostensibly have those pillars provide validation and support for the mystical? Of course, those portions of the science frames that are most supportive of the target beliefs are deemed 'sacred', and those which remain which are conflicting are deemed 'profane'. Thus pseudo-science develops.

6. **Loading of the language:** this is embodied in several ways, a) literalization of language, where certain words, key phrases, slogans, prayers, 'mantras', texts, statements, words that mean 'god', sacred words, etc. are deemed sacred and are to be reserved for use only in the contexts desired by the indoctrinators, and b) where certain new language (lingo) and phrases develop which embody special meaning that is only accessible to the accepted belief participants, that is, codewords, secret meanings, passwords, 'in'-words, and words that convey meaning that the indoctrinators can either find no existing word(s) to convey, or where the indoctrinators need to have a word or phrase that will not be 'polluted' with other 'common' meanings.

(From Top Secret/ Apotheosis (c) 1989 Nexus Seven.

7. *Doctrine over person*: this is a prioritization of the target belief system itself over the 'considerations', 'rights', 'values', 'feelings', and person's physical, emotional, mental, and intuitive life. This allows the belief system to survive any disruption. It provides that the value and importance and worth of the belief system doctrine is greater than the importance of any individual human or all humans. This subordinates human rights to only be of value or worth when they function within the confines and frame of the target belief.

Since everything that is outside of the target belief doctrine is impure and worthless anyway, if a person is comprised of or polluted with that impurity, then such person and their associated 'life' (physical, mental, or emotional) obviously has less value than the belief. Even in circumstances where the person is fully aligned and adherent to the beliefs, their value as a person is less than the value of the belief system itself.

8. *Dispensing of existence*: this means that the right to exist, the value and worth of existence can only be granted by the belief system or the 'source' of the belief system. It is often the 'initiation' that gives the target subject any value at all, and since to be of no value (impure or evil) is to be virtually 'nonexistent', the right of existence can only be granted by the belief system or 'source' of the belief system.

In the examination of these preceding components of mind control, besides these components being evident in cults, religious groups, and secret societies, we can find corresponding elements in both government intelligence work by agents themselves ('GOV', a non-mystical endeavor), intelligence operations that capture agents ('CAP'), as well as 'UFO' abduction and contactee experiences:

Milieu control:
 GOV: surveillance; agency environment
 CAP: controlled environment, no outside contact
 UFO: total environment control; spaceships

Mystical manip:
 GOV: country as 'god'; for the 'president'
 CAP: use of drugs, deceptions, 'as ifs'
 UFO: visions, lights, implants, 'miracles'

Demand for pure:
 GOV: patriotism, no bad habits, uncompromised
 CAP: coming over, being one of us, on the team
 UFO: submission, undeniable experience,

Cult of confess:
 GOV: debriefing, reporting, subordination
 CAP: debriefing, submission, even torture
 UFO: involuntary, telepathic, helpless

Sacred science:
 GOV: tools of the trade; compartmentalization
 CAP: tools of the trade; opportunity promises
 UFO: magical technology; 'better' science

Loading of lang:
 GOV: codes, phrases, lingo, identifiers
 CAP: indoctrinating allegiance, beliefs, rights
 UFO: subliminal; alien 'world' terms

Doctrine over:
 GOV: national security over individual life
 CAP: come clean or be thrown back to 'sharks'
 UFO: purpose/action of aliens inimical to people

Dispensing exist:
 GOV: once agency always agency, else treasonous
 CAP: if you tell, you live and get to exist
 UFO: release from abducted control, return

SOCIAL REVERSAL OF MIND CONTROL

A Channeled Solution to World and Societal Stagnation

The entity known as Bashar came up with some interesting observations in regard to societal stagnation:

Question: With all the conflict in the world, what do our world leaders lack in order to bring peace to the Earth?

Answer: Trust in the self-empowerment of every individual.

The idea is simply lack of trust - each and every individual is capable of great understanding. You have created your government leaders to be what they are. You are your government. So in a sense what is lacking is also the willingness on the part of the individuals in your society to take back the responsibility for the things in life that they fear -- to take back their power, and for you to actively generate the circumstances in your life that you prefer to experience in your life. You can then share the idea with the individuals in your government -- the awareness and the knowledge that they do not have to "go it alone."

In this way, they do not have to "run", "dominate", and "control" everything. You can in that way allow them to gain their self-empowerment even as you gain your own.

Editor Comment: What has to happen here is that the Illuminati and the military industrial complex will have to release control of the society, which is not likely to happen unless there is some large factor which would affect the whole planet simultaneously. To allow this kind of change to happen as a "matter of course" would take a long, long time. There is no immediate expectation that the negative individuals in control would suddenly "see the light". What Bashar says is valid, but it would take some sort of "overwhelming factor" to bring about a definitive change of that magnitude. In addition, we have the problem of negative non-human beings that are contributing to the problem. These beings have no interest in the development of human civilization, and wish to keep the "status quo" at any cost.

An Interview with a CIA Employee

The interview will be reviewed by including excerpts. In some cases, I will present it in question and answer format for clarity.

Q: A career officer doesn't need to be debriefed by mind control, does he?

A: You want to bet? ... this debriefing is done in such a way, in many cases, to cause actual memory damage.

Q: What about how the government works?

A: Don't kid yourself. This country is controlled by the Pentagon. All major decisions are made by the military. The CIA's just the whipping boy. NSA are the ones who have the hit teams. Look into their records - you won't find a thing. Look into their budget - you can't. The CIA is just a figurehead, but as far as intelligence goes, the NSA's far superior to them - far in advance in the 'black arts'. The CIA gets blamed for what the NSA does. NSA is far more vicious and far more accomplished in its operations. The American people are kept in ignorance about this - they should be, too.

Q: What you're saying is that the military is more dangerous to our democracy than the CIA or other intelligence groups?

A: The CIA gathers the information, but the military heads the show.

Q: What you are suggesting, I guess, is that there is an invisible coup d'etat which has occurred in the United States?

A: OK. There is a group of about eighteen or twenty people running this country. They have not been elected. The elected people are only figureheads for these guys who have a lot more power than even the President of the United States.

Q: You mean the President is powerless?

A: Not exactly powerless. He has the power to make decisions on what is presented to him. The intelligence agencies tell him only what they want to tell him. Think of the Pentagon papers. It's public knowledge that the CIA has falsified documents and done a host of other things. You have to wonder at American stupidity. What people don't know is that the global corporations have their own version of the CIA. Where they don't interface with the CIA, they have their own organizations - all CIA-trained. They also have double agents inside the CIA who are loyal to those corporations.

Q: What do you know about the use of pain-drug hypnosis?

A: They use several different things. I've seen guys coming back with blanks only in certain places of their memory. They use hypnosis and hypnotic drugs. They also use electronic manipulation of the brain. When they use hypnosis, they'll be using at the same time a set of earphones which repeat 'You do not know this or that' over and over. They turn on the sonics at the same time, and the electrical patterns which give you memory are scrambled. You can't hear the ultrasonics and you can't feel it, unless they leave it on and then it boils your gray matter.

Editor's Note: CIA documents released in 1976 revealed that ultrasonics research was undertaken for a period of more than 20 years. The documents said that the research had stopped.

Q: I thought that research had stopped on ultrasonics?

A: Yeah, the research has stopped. They've gone operational. It ain't research any more. They know how to do it. Our Constitution doesn't permit us to do much that is legal.

Q: Do the police use mind control?

A: At the highest levels, yes. The FBI uses it, and they give a lot of help to local police. Let me tell you something: the cheapest commodity in the world is human beings.

Q: What about conspiracies?

A: All you hear about are left-wing conspiracies to overthrow our government. You never hear about right-wing conspiracies. Well, some of these right-wing groups are far more dangerous than the left wing groups. The right wing is usually retired military. If the right wing took over right now there would be a military dictatorship. We've got one right now, but it ain't overt, it's subtle.

Q: You mean those 20 men you were talking about?

A: Yeah... if the people of this country actually knew that, they would say 'no' the next time they were asked to go to Vietnam. We need the people behind us to fight a war, and if they knew the true facts, who's running things, there wouldn't be the following we'd need to defend the country. That fact alone keeps the sham of politics and 'free elections' going. The American people, like most people, have to feel that they have some right in what they do, that they're the 'good guys'. This is the reason we have never lost a war and have never won a peace. You've got to maintain the sham of freedom, no matter what. It wouldn't make any difference what party is in charge or whether it was the elected government or what is called the cryptocracy that was running it; from an operational sense, the government would operate as it presently is.

Many thanks to the Author, who
gave his kind permission to
present his material to you.

MASS MURDERERS IN WHITE COATS

PSYCHIATRIC GENOCIDE IN NAZI GERMANY AND THE UNITED STATES

BY

LENNY LAPON

PSYCHIATRIC GENOCIDE RESEARCH INSTITUTE

FROM HARVARD TO BUCHENWALD:

A CHRONOLOGY OF PSYCHIATRY AND EUGENICS

The attitudes and practices of psychiatrists in Nazi Germany that enabled them to slaughter 300,000 of their "patients" were similar to those of psychiatrists and psychologists of the same period in the United States. In both countries these attitudes had common roots. And most importantly, these same attitudes, theories and practices are still prevalent today in our own country (and throughout most of the world). That they have not yet resulted in as large a psychiatric holocaust here as in Nazi Germany should be considered only as a warning and should not prevent us from stopping the spread of this psychiatric malignancy (if you'll forgive the medical metaphor).

Two recent books that give a thorough description of the development and continued presence of many of these views and theories are:

1. The Legacy of Malthus: The Social Costs of the New Scientific Racism by Allan Chase,(1) and
2. From Genesis to Genocide: The Meaning of Human Nature and the Power of Behavior Control by Stephan L. Chorover.(2)

Many of the pseudoscientific, psychiatric and social theories that advocate the locking up (i.e., "institutionalization"), sterilization and killing (i.e., "euthanasia") of people considered by some to be "not worthy of living" fall under the heading of eugenics. My 1966 copy of Webster's Seventh New Collegiate Dictionary defines eugenics as "a science that deals with the improvement (as by control of human mating) of hereditary qualities of a race or breed."(3) The idea that one race

or group of people is superior to another is, of course, a racist, political and pseudoscientific, not scientific, idea. Unfortunately, many people considered to be scientists and "social scientists" advocate this type of racism and discrimination. "Sociobiology" is a related pseudoscience that claims to give biological reasons (e.g., heredity, chemical imbalances in the blood and brain, etc.) for social and political actions and conditions. Eugenicians and sociobiologists have been blaming the victims of poverty, unemployment, racism and other discriminations for their condition for over a hundred years now.

There are many psychiatrists and psychologists who do not believe that "mental illness" and "mental retardation" are inherited or biologically or chemically caused. They look instead at the "patient's" environment, though usually not much beyond the family. Yet they still treat the pain and suffering* of people who are so labeled with many, if not all, of the same torturous methods as the "genetically-oriented" doctors. They call us by the same degrading and dehumanizing labels--"schizophrenic", "psychotic", "mentally defective"--and they forcibly commit people to psychiatric institutions, give them/us drugs, electroshock and even psychosurgery. They use as well the techniques of behavior modification, an attempt to force changes in behavior and attitudes by controlling the person's environment, a most inhumane and totally undemocratic concept à la B.F. Skinner. And they use isolation cells and shackles which they euphemistically call "quiet rooms" and "restraints".

The following is a chronology that demonstrates some of the similarities in the origins and parallel development of eugenic and psychiatric ideas and practices in the United States and Germany. In the case of Germany, most of the included events occurred before or during the Nazi period. In the case of the U.S., events up to the present are included. The list has a few entries for other countries and could have included other examples. Further information can be obtained from the sources cited in the references and especially from the works of Chase and Chorover just mentioned.

* I do not mean to imply that all people labeled "mentally ill" are experiencing severe emotional pain. Many are, but many also get labeled "psychotic", "manic", etc. for being "too happy" or for not wanting to conform to certain values imposed on them by society (i.e., not behaving "appropriately").

1851.

...a respected white physician, Dr. Samuel A. Cartwright, created a mental illness peculiar to Black people. The effort of the slave to gain his freedom by running away from the plantation, he said, was a symptom of a serious mental disease called DRAPETOMANIA. Dr. Cartwright maintained that this hideous condition could be cured by recapturing the 'patient', rubbing him down with oil and beating him into submission.(4)

1869. The English psychologist Francis Galton, cousin of Charles Darwin, published Hereditary Genius. Cornell University anthropology professor Davydd Greenwood described this work as "an impassioned brief for hereditary aristocracy that became the first major document of the modern eugenics movement."(5) Chorover wrote of this book:

Galton's inquiry into 'hereditary genius' led him to view 'the incompetent, the illing, and the desponding' as a threat to the well-being of society because of their habit of producing large numbers of impoverished, sick, and miserable children. The upper classes, he argued, should be encouraged to have more children, whereas the lower classes should be induced, if possible, or compelled, if necessary, to have fewer.(6)

Galton's racist view of Blacks was made clear when he wrote, "The average intellectual standard of the negro is some two grades below our own."(7)

1875. U.S. Immigration law excluded "coolies, convicts, and prostitutes" as "undesirable" aliens.(8)

1882. "Lunatics and Idiots" were added to those excluded under U.S. Immigration law.(9)

1883. Galton introduced the term "eugenics" to describe his ideas and proposed practices of racial superiority and sterilization.

1884. Galton stated "The Jews are specialized for a parasitical (Galton's emphasis) existence upon other nations..."(10)

1890's. The superintendent of a Kansas home for the "feeble-minded" castrated 50 children before public revulsion forced him to stop.(11)

1895. German eugenicist Dr. Alfred Ploetz published The Excellence of Our Race and the Protection of the Weak, in which he "attempted to show...that a misdirected humanitarianism was threatening the quality of the race by fostering the protection of its weaker members."(12)

1897. In his presidential address before the American Association for the Study of Feeble-mindedness, Dr. M.W. Barr strongly advocated sterilization.(13)

1898. A eugenic sterilization bill was unsuccessfully introduced into the Michigan Legislature. It provided for the castration of all inmates of the Michigan Home for the Feeble-minded and Epileptic.(14)

1900-1903. Wilhelm Schallmayer won an essay contest sponsored by Alfred Krupp, the head of Germany's largest armaments company, for answering the question, "What does the theory of evolution teach us in regard to the internal political development and legislation of states?" Schallmayer put forward a eugenics program that included premarital screening by doctors for "undesirable" inheritable traits in his prize-winning book, Inheritance and Selection in the Life-History of Nationalities: A Sociopolitical Study Based upon the Newer Biology [sociobiology].(15)

1903. "Epileptics and insane persons" were added to those "undesirable" aliens excluded under U.S. Immigration law.(16)

1904. The Carnegie Institution of Washington, a corporate foundation endowed by Andrew Carnegie, the steel tycoon, established a biological experiment station at Cold Spring Harbor, New York. Eugenicist Charles Benedict Davenport was its first director.(17) In both the U.S. and Germany the eugenics movement was in large part supported by corporate funds.

Alfred Ploetz founded the Archiv für Rassen und Gesellschaftsbiologie (Archive for Racial and Social Biology), the chief journal of the German eugenics or race hygiene movement.(18)

1907. Indiana passed the world's first compulsory sterilization law for all "confirmed criminals, idiots, rapists and imbeciles" who were confined in state institutions. By 1980 thirty states and the colony of Puerto Rico passed similar laws.(19)

"Imbeciles and feeble-minded persons" were added to those "undesirable" aliens excluded under U.S. Immigration law.(20)

1912. The First International Congress of Eugenics was held at the University of London. The president of the Congress was Major Leonard Darwin, son of Charles Darwin. One of the English vice-presidents was First Lord of the Admiralty Winston Churchill, later Prime Minister. German vice-presidents included M. von Gruber, professor of hygiene at Munich and Dr. Alfred Ploetz, president of the International Society for Race Hygiene. American vice-presidents included Charles W. Elliot, president emeritus of Harvard University and Alexander Graham Bell.(21)

Psychologist Henry Goddard published The Kallikak Family: A Study in the Heredity of Feeble-Mindedness.(22) In this year Goddard also administered IQ tests to immigrants at Ellis Island, finding that 83 percent of the Jews, 80 percent of the Hungarians, 79 percent of the Italians and 87 percent of the Russians who wanted to enter the United States were "feeble-minded."(23)

1914. The First National Congress on Race Betterment was held in Battle Creek, Michigan. A "segregation and sterilization program" was proposed to reduce the number of "defective and antisocial" people in the population from 10 percent to 5.77 percent by 1955 by sterilizing 5.76 million Americans.(24)

By 1914 eugenics was taught in the U.S. at Harvard, Columbia, Cornell, Brown, Wisconsin, Northwestern, Clark and other universities. In Germany, in this year, the Reichstag (the German parliament) considered a eugenic sterilization law.(25)

1916. Madison Grant published The Passing of the Great Race, or the Racial Basis of European History in

New York, in which he stated, "Mistaken regard for what are believed to be divine laws and a sentimental belief in the sanctity of human life tend to prevent both the elimination of defective infants and the sterilization of such adults as are themselves of no value to a community. The laws of nature require the obliteration of the unfit and human life is valuable only when it is of use to the community or race."(26)

Lewis M. Terman, professor of psychology at Stanford University published the Stanford-Binet IQ test in the United States.(27) Chorover credited Terman with "injecting race into the IQ debate." Terman claimed that "mental deficiency is very common among Spanish-Indian and Mexican families...and also among negroes." He also warned that "if we would preserve our state for a class of people worthy to possess it, we must prevent, as far as possible, the propagation of mental degenerates."(28)

1920. Alfred Hoche, professor of psychiatry and director of the psychiatric clinic in Freiburg, and Karl Binding, a German judge published The Release of the Destruction of Life Devoid of Value in Leipzig. This work advocated the killing of people labeled "mentally ill" and "mentally defective", and used the euphemism "euthanasia". Some quotes from this book are:

...all the institutions for mentally sick persons...the tremendous care that these creatures receive; creatures of no value at all...(29)

...Incurable idiots...have no will for life or for death. They give no definite consent to the euthanasia.... Their life is completely useless, but they don't consider it unbearable.(30)

...for the idiots...the continuation of life for society as well as for the person himself has no value.(31)

Dr. John E. Lind, a psychiatrist at St. Elizabeth's Hospital in Washington, published his racist view of "the psychology of the African" in the Psychoanalytic Review:

The precocity of the children, the early onset of puberty, the failure to grasp subjective ideas, the strong sexual and herd instincts with the few inhibitions, the simple dream life, the easy reversion to savagery when deprived of the restraining influence of the whites (as in Haiti and Liberia), the tendency to seek expression in such rhythmic means as music and dancing, the low resistance to such toxins as syphilis and alcohol, the sway of superstition, all these and many other things betray the savage heart beneath the civilized exterior. Because he wears a Palm Beach suit instead of a string of cowries [brightly colored shells], carries a gold-headed cane instead of a spear, uses the telephone instead of beating the drum from hill to hill, and for the jungle path has substituted the pay-as-you-enter streetcar, his psychology is no less that of the African.(32)

1921. The Second International Congress of Eugenics was held in New York. The sponsoring committee included Secretary of Commerce Herbert Hoover and the presidents of Clark University, Smith College and the Carnegie Institution of Washington.(33)

1922. H.H. Laughlin, the Expert Eugenics Agent of the United States House of Representatives Committee on Immigration and Naturalization published the Model Eugenic Sterilization Law.(34) This model formed a basis for many state sterilization laws and for Nazi Germany's 1933 law. Laughlin listed the categories of people who were to be subjected to mandatory sterilization:

The socially inadequate classes, regardless of etiology or prognosis...are the following: (1) Feeble-minded; (2) Insane (including the psychopathic); (3) Criminalistic (including the delinquent and wayward); (4) Epileptic; (5) Inebriate (including drug-habitues); (6) Diseased (including the tuberculous, the syphilitic, the leprous, and others with chronic, infectious, and legally segregable diseases); (7) Blind (including those with seriously impaired vision); (8) Deformed (including the crippled); and (10) Dependent (including orphans, ne'er-do-wells [sic], the homeless, tramps and paupers).(35)

1925. Adolf Hitler published *Mein Kampf* to the glee of the eugenicists. Hitler's book included the following statements:

It is a half-measure to let incurably sick people steadily contaminate the remaining healthy ones.... The demand that defective people be prevented from propagating equally defective offspring is a demand of the clearest reason and if systematically executed represents the most humane act of mankind. It will spare millions of unfortunates undeserved sufferings, and consequently will lead to a rising improvement of health as a whole.(36)

The stronger must dominate and not blend with the weaker, thus sacrificing his own greatness. Only the born weakling can view this as cruel, but he after all is only a weak and limited man.(37)

It was and it is Jews who bring the Negroes into the Rhineland, always with the same secret thought and clear aim of ruining the hated white race by the necessarily resulting bastardization, throwing it down from its cultural and political height.(38)

The folkish state must make up for what everyone else today has neglected in this field. It must set race in the center of all life. It must take care to keep it pure.... It must see to it that only the healthy beget children; that there is only one disgrace: despite one's own sickness and deficiencies, to bring children into the world.... It must put the most modern medical means in the service of this knowledge. It must declare unfit for propagation all who are in any way visibly sick or who have inherited a disease...and put this into actual practice.

Those who are physically and mentally unhealthy and unworthy must not perpetuate their suffering in the body of their children. (Hitler's emphasis).(39)

1927. Oliver Wendell Holmes wrote the United States Supreme Court's decision in *Buck v. Bell*. Buck was Carrie Buck, an 18-year old woman committed to the State Colony for Epileptics and Feeble-Minded in Virginia, where Bell was the superintendent. Carrie's mother was also an inmate at the same institution. Carrie had recently given birth to a child and the state of Virginia wanted to have her sterilized against her will. Associate Justice Holmes wrote,

The judgment finds the facts that have been recited and that Carrie Buck 'is the probably potential parent of socially inadequate offspring, likewise afflicted, and she may be sexually sterilized without detriment to her general health and that her welfare and that of society will be promoted by her sterilization,' and thereupon makes the order...we have seen more than once that the public welfare may call upon the best citizens for their lives. It would be strange if it could not call upon those who already sap the strength of the State for those lesser sacrifices, often not felt to be such by those concerned, in order to prevent our being swamped with incompetence. It is better for all the world, if instead of waiting to execute degenerate offspring for crime, or let them starve for their imbecility, society can prevent those who are manifestly unfit from breeding their kind. The principle that sustains compulsory vaccination is broad enough to cover cutting the Fallopian tubes.... Three generations of imbeciles are enough.(40)

1927-1933. During this period Austrian psychiatrist Manfred Sakel developed insulin shock (ICT-"Insulin Coma Treatment") in Berlin and Vienna. This is a procedure whereby the "patient" is injected with enough insulin to induce a coma.(41) Leonard Roy Frank wrote, "Although the rate of death from ICT is usually reported by psychiatrists as being from 0.5 to 2 percent, one extensive 1941 study of state hospitals revealed a 4.9 percent death rate.(42)

That ICT was used extensively in Nazi Germany is indicated by the statement of psychiatrist Helmut Ehrhardt, "Already by 1937 there was, I think, no neuropsychiatric university clinic in Germany in which ICT was not used."(43)

* Ehrhardt is a German psychiatrist who is also a member of the American Psychiatric Association. He was trained in Nazi Germany at the University of Breslau where he received a Ph.D. in psychology in 1939 and an M.D. in 1941.(44)

1930. Ernst Rüdin, professor of psychiatry at Munich and Director of the Department of Heredity at the Kaiser Wilhelm Institute visited the United States and was praised by leaders of the Carnegie Foundation. Rüdin, later architect of Nazi Germany's sterilization law was financially supported in his work by a large grant from the Rockefeller Foundation.(45)

1932. The Third International Congress of Eugenics was held in New York. Dr. Theodore Russell Robie of the Essex County Mental Hygiene Clinic in New Jersey presented "Selective Sterilization for Race Culture" in which he called for the sterilization of at least the 14,000,000 Americans who had received low intelligence test scores since World War I. In this third year of the Great Depression, Robie said,

...there are those who believe that our population has already attained a greater number than is necessary for the efficient functioning of the race as a whole. Certainly our present picture of millions of unemployed would point to the belief that this suggestion is a reasonable one. It would undoubtedly be found, if such research was possible, that a major portion of this vast army of unemployed are social inadequates, and in many cases mental defectives, who might have been spared the misery they are now facing if they had never been born. It would certainly be understandable how many of them would prefer not to have been born, if they could have known what was in store for them on this earth where the struggle for existence, and the urge toward the survival of the fittest makes it necessary for all those who would survive to possess a native [genetic] endowment of at least average intelligence.(46)

1933. Adolf Hitler and the National Socialist (Nazi) Party came to power in Germany.

An article by Dr. M.H. Goering, a cousin of Marshal Hermann Goering, appeared in Germany's Journal of Psychotherapy, instructing psychotherapists to make "a serious scientific study of Adolf Hitler's fundamental work mein Kampf, and to recognize it as a basic work." Carl Jung, the world-famous psychiatrist, was the editor of this journal.(47)

Madison Grant published Conquest of a Continent, a "racial history of the United States" and had copies sent to Mussolini, Nazi Professor Dr. Eugen Fischer at the Kaiser Wilhelm Institute for the Study of Anthropology, Human Heredity and Eugenics in Berlin, Dr. Alfred Rosenberg (Hitler's chief scientific adviser), and to Nazi race hygienist Professor Dr. Fritz Lenz at the University of Munich.(48)

Hitler put into law the Nazi Act for Averting Descendants Afflicted with Hereditary Diseases. This sterilization law was directly based on H.H. Laughlin's Model Eugenical Sterilization Law of 1922. Compare the categories of victims under Laughlin's model (check 1922 in this chronology) with the following criteria for sterilization used by the Nazi Eugenic Courts that were set up in 1933:

...(1) Congenital Mental Deficiency; (2) Schizophrenia, or split personality; (3) Manic-Depressive Insanity; (4) Inherited Epilepsy; (5) Inherited Chorea; (6) Inherited Blindness; (7) Inherited Deafness; (8) Any grave physical defect that has been inherited; (9) Chronic alcoholism, when this has been scientifically determined to be symptomatic of psychological abnormality...(49)

Between 1933 and 1939, 375,000 forced sterilizations were performed under this act. According to Wallace R. Duell, a German correspondent for the Chicago Daily News, the official rationales were as follows:

Congenital feeble-mindedness	203,250
Schizophrenia	73,125
Epilepsy	57,750
Acute alcoholism	28,500
Manic-depressive insanity	6,000
Hereditary deafness	2,625
Severe hereditary physical deformity	1,875
Hereditary blindness	1,125
St. Vitus' dance	750

Total 375,000(50)

According to the Central Association of Sterilized Persons organized in Germany in 1945, the total number of people sterilized under Hitler's Third Reich (1933-1945) was two million.(51)

H.H. Laughlin received an honorary degree from Germany's Heidelberg University, a major Nazi research center on "race purification" for his contributions to eugenics.(52)

1938. Psychiatry professor Ernst Rüdin wrote that it was thanks to Hitler that "the dream we have cherished for more than thirty years of seeing racial hygiene converted into action has become reality."(53)

1935. Egas Moniz performed the first lobotomy in Portugal. Four years later he was shot and partially paralyzed by a victim of one of his lobotomies, and in 1955 he was beaten to death by another of his "patients" who obviously didn't welcome his "help".(54)

The Nazis instituted the Law for the Protection of the Genetic Health of the German People, which required couples to have a medical examination before marriage. It forbade marriage if one person was considered genetically defective. It also did not allow marriage between Jews and Aryans and was later extended to include Gypsies, Slavs and other people deemed inferior.(55)

Dr. Alexis Carrel, a French-American Nobel Prize winner published Man, the Unknown in which he advocated killing the "mentally ill and criminals" in "euthanasia" institutions. In his last chapter, "The Remaking of Man" Carrel wrote,

There remains the unsolved problem of the immense number of defectives and criminals. They are an enormous burden for the part of the population that has remained normal.... Why do we preserve these useless and harmful beings?.... Why should society not dispose of the criminals and the insane in a more economical manner?.... In Germany, the Government has taken energetic measures against the multiplication of inferior types, the insane and criminals.... Perhaps prisons should be abolished. They could be replaced by smaller and less expensive institutions. The conditioning of petty criminals with the whip, or some more scientific procedure, followed by a short stay in hospital, would probably suffice to insure order. Those who have murdered, robbed while armed.... kidnapped children, despoiled the poor of their savings, misled the public in important matters, should be humanely and economically disposed of in small euthanasia institutions supplied with proper gases. A similar treatment could be advantageously applied to the insane, guilty of criminal acts. Modern society should not hesitate to organize itself with reference to the normal individual.(56)

1936. Walter Freeman and James W. Watts introduced lobotomy into the United States.(57)

1937. Professor Earnest A. Hooten, a Harvard University anthropologist and president of the American Association of Physical Anthropologists was described in the New York Times as one of the leading authorities on human evolution and was quoted as follows:

...probably compulsory sterilization alone would serve in the case of the insane and the mentally deficient, but it is very difficult to enforce such a measure in a democracy, unless it has been preceded by an educational campaign which has reached all of the teachable and socially minded individuals of the electorate.... I think that a biological purge is the essential prerequisite for a social and spiritual salvation.(58)

A few days later Hooten urged the U.S. to "encourage a sit-down reproductive strike of the busy breeders among the morons, criminals and social ineffectuals of our population."(59)

The German edition of Madison Grant's Conquest of a Continent was published in Berlin with a special forward by Professor Dr. Eugen Fischer of the Kaiser Wilhelm Institute. Fischer wrote, "No one has as much reason to note the work of the this man [Grant] with the keenest of attention as does a German of today—in a time when the racial idea has become one of the chief foundations of the National Socialist State's population policies."(60)

1938. Ugo Cerletti became the first to use electroshock (ECT—"electroconvulsive treatment") on a human being. It was done in fascist Italy. Cerletti got the idea from watching hogs get shocked into unconsciousness before they were killed at a slaughterhouse. The first victim was a 39-year old engineer who had been arrested at a railroad station for "wandering about without a ticket on trains ready for departure." After the first shock of 80 volts, which failed to produce a convulsion, and before the second one of 110 volts, which did, the "patient" cried out, "Not another one! It's deadly!" Present at this first administration of electroshock was Lothar B. Kallnowsky who today is a member of the American Psychiatric Association and has been one of the most avid proponents and users of this torture in the United States.(61) Kallnowsky has authored several books and hundreds of articles on electroshock.

Franz J. Kallman, a well-known German-born and educated U.S. psychiatrist who worked in Nazi Germany until 1936 wrote in Eugenical News that "compulsory sterilization of all hospitalized schizophrenics would not prevent more than from 1 percent to 3 percent of schizophrenic individuals" from being born. According to researcher Peter Breggin, Kallman therefore called for "legal power" to sterilize "tainted children and siblings of schizophrenics" and to prevent marriages involving "schizoid eccentrics and borderline cases."(62)

1939. Psychiatrists in Nazi Germany began murdering "mental patients" at Brandenburg, one of the six killing institutions used for the "Euthanasia" Program. At least 300,000 people labeled "mentally ill" and "mentally defective" were slaughtered by gassing, starvation and the injection of lethal drugs by the end of World War II in 1945. (I have described this mass murder in detail in Chapter 2.)

1941. Viktor Brack, one of the heads of the "Euthanasia" Program sent a "Report on Experiments in X-Ray Castration" to Himmler, in which he stated, "a two-tube installation could thus sterilize 150-200 persons a day, twenty installations some 3000-4000 persons a day."(63)

The Nazi program for the killing of psychiatric inmates and others was extended to Dachau and the other concentration camps under the code name of 14f13.

1942. U.S. psychiatrist Foster Kennedy wrote an article in the July issue of the chief journal of the American Psychiatric Association advocating the killing of "retarded" children, the "utterly unfit", to relieve them of "the agony of living" and to spare their parents expense and anguish. Kennedy said, "So the place for euthanasia, I believe, is for the completely hopeless defective, nature's mistake, something we hustle out of sight, which should never have been seen at all."(64)

1945. Lancet, the major British medical journal, published "Sterilization of the Insane in the USA." According to this article, which was based on information in the Journal of the American Medical Association, over 42,000 people were sterilized in the U.S. during the three-year period of 1941-1943. California led all states with over 10,000 and the breakdown was:

"insane"	20,600
"feeble-minded"	20,453
others	1,563
plus "an unknown number carried out privately in other hospitals."(65)	

1946. The Doctors' Trial began at Nuremberg. Just a few of the multitude of Nazi doctors involved in the "Euthanasia" Program and the infamous experiments on inmates of concentration camps were brought to trial.

Dr. Pfannmueller, psychiatrist and director of a state institution in Nazi Germany where many children were starved to death in the name of "euthanasia", testified at Nuremberg,

...euthanasia and the work of the National Board had, in my view, nothing to do with National Socialism. They were just as legal as the regulations for prevention of transmission of hereditary disease and infection in marriage. These laws were passed during the National Socialist regime. But the ideas from which they arose are centuries old.(66)

1947. While a defendant in the Doctors' Trial for his role as a leader of the "Euthanasia" Program and for other war crimes, Karl Brandt realized that many of the Nazi ideas concerning "life not worthy of living", sterilization and the like had been based on ideas and writings from the United States. He reminded his U.S. prosecutors of this fact by introducing several of those works as evidence in his defense. One was the book, The Passing of the Great Race by Madison Grant (See 1916 of this chronology). Grant was chairman of the New York Zoological Society and curator of the American Natural History Museum. Brandt excerpted the following from a 1923 German translation of this book,

...A strict selection by exterminating the insane or incapable—in other words, the scum of society—would solve the whole problem, in one century, and would enable us to get rid of the

undesirable elements who people our prisons, hospitals and lunatic asylums. The individual may be supported, brought up, and protected by the community during his life time, but the state must see to it by sterilization, that he is the last individual of his line of descent, otherwise future generations too, will be burdened with the curse of an ever increasing number of victims of misguided sentimentality.(67)

Brandt also used as evidence a copy of Man, the Unknown(68) by Alexis Carrel (See 1935 of this chronology) and a book by Dr. Erich Ristow, a German lawyer, entitled Law Concerning Hereditary Health(69) which pointed out Indiana's forced sterilization law of 1907 and an unsuccessful attempt to pass a similar law in 1898 by the state of Michigan. Another defense exhibit, Human Selection and Eugenics by Dr. Fritz Lenz and Dr. Bauer contained this historical fact:

The credit for introducing vasectomy of the male for the prevention of inferior progeny belongs to the American physician Sharp. During the years of 1899 to 1907, Sharp sterilized on his own responsibility, 176 mentally deficient persons in a prison in the State of Indiana.(70)

Psychiatrist Edwin Katzen-ellenbogen, former member of the faculty at Harvard Medical School was convicted of war crimes he had committed as a doctor at Buchenwald Concentration Camp. During his trial in Dachau, Germany by the U.S. Army, he testified that he had "...drafted for the governor the law for sterilization of epileptics, criminals and incurably insane for the state of New Jersey, following the state of Indiana which first introduced the law in 1910."(71)

1948. Walter Freeman, who performed more than 3500 lobotomies, demonstrated his icepick technique at the University of Virginia in Charlottesville. Patricia Derian, then a student nurse, described the procedure which was done in front of lights and cameras in an amphitheater full of doctors from throughout the state:

As each patient was brought in, Dr. Freeman would shout at him that he was going to do something that would make him feel a lot better. The patients had been given electroshock just before they were brought in; that's probably why he yelled at them. The shock was the only medication they received, he gave nothing for the pain, no anesthesia, no muscle relaxant.

After the patient was placed on the table, Dr. Freeman would clap his hands and his two assistants would hold up an enormous piece of green felt the color of a pool table. That was the photographic backdrop. Dr. Freeman would direct the placement of lights so that each operation could be photographed, and he checked carefully to be sure that the cameraman was ready, that he had a good angle showing Dr. Freeman with his instrument, that there was no shadow to spoil the picture. His main interest during the entire series of lobotomies seemed to be on getting good photographic angles. He had each operation photographed with the icepick in place.

When all was ready, he would plunge it in. I suppose that was part of his surgical technique, if there is a technique for such surgery. You probably have to plunge it in to break through the back of the eye socket. He lifted up the eyelid and slid the ice-pick-like instrument over the eyeball. Then he would stab it in suddenly, check to be sure the pictures were being made, and move the pick from side to side to cut the brain.(72)

Freeman called lobotomy "mercy killing of the psyche."(73) According to Schefflin and Opton in their book The Mind Manipulators, 100,000 people received psychosurgical operations in one ten-year period, 1946-1955, half of them in the U.S. (74)

* Katzen-ellenbogen was mistaken about the year Indiana passed its first sterilization law. It was in 1907, not 1910. Perhaps he drafted the New Jersey law in 1910.

1949. Egas Moniz, the first lobotomist, received the Nobel Prize for Medicine in recognition of his "discovery".(75) (See 1935 in this chronology).

Beginning in this year (if not earlier) and, despite

CIA assertions to the contrary, continuing to the present, psychiatrists and psychologists in the U.S. have played a key role in vast mind control projects of the CIA and other government intelligence agencies. The projects' code names included BLUEBIRD, ARTICHOKE, MK ULTRA AND MK DELTA. The details of these projects are beyond the scope of this book. Briefly, however, they included the use of drugs such as LSD, BZ (a drug similar to LSD but 10 times more powerful).(76) and many psychiatric drugs, electroshock, psychosurgery, electronic brain implants, hypnosis, brainwashing and other experimental techniques to control people's minds. One of their goals was to program assassins to kill against their will and then to forget they had been instructed to do so.(77) Another was to behaviorally condition subjects to be used for various other clandestine intelligence operations, while a third was for general purposes of control of the American people.

Many "mental patients" and other prisoners were used as guinea pigs--often unwitting ones--for these experiments. One CIA memo read,

...It was essential to find an area where large numbers of bodies would be used for research and experimentation. Dr. (deleted) stated that in connection with the testing of drugs, he was quite certain a number of psychiatrists all over the United States would be willing to test new drugs, especially drugs that affect the mind.(78)

According to Madness Network News,

Between 1953-1967, the CIA paid Ewen Cameron over \$18,000 to test LSD, Thorazine, and sensory deprivation on mental patients. Dr. Carl Pfeiffer was paid \$25,000 a year by the CIA to drug prisoners with LSD. Dr. Harris Isbell drugged prisoners with LSD for 11 years under CIA auspices. Dr. Louis Jolyon West of UCLA, Dr. Sidney Maltz, Dr. James B. Cattell, Dr. Amadeo Marrassi, Dr. Paul Hoch, and many other psychiatrists were also on the CIA payroll.(79)

Psychosurgeon Robert Heath of Tulane University in 1955 did research for the U.S. Army involving the use of LSD on psychiatric inmates in whom he had implanted depth-electrodes.(80) With CIA funds Dr. Isbell of the U.S. Public Health Service Hospital in Lexington, Kentucky, experimented on mostly Black inmates (who were drug addicts) with LSD, mescaline, psilocybin, marijuana,

scopolamine and dozens of other drugs. Isbell paid off his subjects in narcotics.(81) The U.S. Army Chemical Corps, in the period from 1952 to 1957, gave Dr. Paul Hoch and the New York State Psychiatric Institute nearly \$200,000 for research on the effects of mind control drugs on humans.(82) Hoch later headed up New York State's Department of Mental Hygiene.

(In the interest of cohesion and readability I have included this entire period under 1949, the first year of these mind control programs).

1950. Walter Freeman and James W. Watts published Psychosurgery in the Treatment of Mental Disorders and Intractable Pain, in which they described one Black victim as follows:

We vividly recall a nigger of gigantic proportions who for years was confined to a strong room at St. Elizabeth's Hospital. When it came time to transfer her to the Medical Surgical Building for operation (lobotomy) five attendants were required to restrain her while the nurse gave her the hypodermic. The operation was successful in that there were no further outbreaks, but for many months after the operation this patient's reputation was such that she was allowed few privileges, and even three years after operation, when she could well have been taken care of at home, her husband refused to try it. He was still scared of the 72 inches and 300 lbs. of ferocious humanity. Yet from the day after operation (and we demonstrated this repeatedly to the timorous ward personnel) we could playfully grab Oretta by the throat, twist her arm,

tickle her in the ribs and slap her behind without eliciting anything more than a wide grin or a hoarse chuckle. This patient has been earning her living in Denver for the past two years.(83)

1954. Smith, Kline and French, one of the United States' larger drug companies put the first of the "major tranquilizers", Thorazine (chlorpromazine), on the market. Peter Schrag, in his book Mind Control, estimated that ...by 1975 American physicians were writing 240 million pharmacy prescriptions annually for psychotropic medication for people who were not (emphasis added) hospitalized--roughly one

for every man, woman and child in the country--enough pills all told to sustain a \$1.5 billion industry and to keep every American fully medicated for a month.(84)

In 1977 the National Institute of Drug Abuse estimated that 4,794,000 prescriptions had been written for Thorazine alone in the fiscal year ending April 1977--for a total of 270,951,000 pills.(85)

1955. Dr. Saul Krugman conducted an experiment at Willowbrook State Hospital in New York, in which children, most of them labeled "retarded" were deliberately infected with active hepatitis virus as part of a study of the disease.(86)

1960s. Henry E. Garrett, Chairman of the psychology department at Columbia University and a former president of the American Psychological Association published a series of pamphlets to justify race segregation in the United States. In one such pamphlet, Breeding Down, he wrote,

You can no more mix the two races and maintain the standards of White Civilization than you can add 80 (the average IQ of Negroes) and 100 (the average IQ of Whites), divide by two and get 100. What you would get would be a race of 90's, and it is that 10 percent differential that spells the difference between a spire and a mud hut; 10 per cent--or less--is the margin of civilization's 'profit'; it is the difference between a cultured society and savagery. Therefore, it follows, if miscegenation would be bad for White people, it would be bad for Negroes as well. For, if leadership is destroyed, all is destroyed.(87)

Chorover reported that 500,000 copies of Garrett's pamphlets on the "evils" of interracial marriage were distributed free to American teachers by opponents of integrated education.

1967. Three psychosurgeons, Vernon H. Mark, Frank R. Ervin and William H. Sweet had a letter published in the Journal of the American Medical Association under the heading "Role of Brain Disease in Riots and Urban Violence." In part, the letter read:

That poverty, unemployment, sium housing, and inadequate education underlie the nation's urban riots is well known, but the obviousness

of these causes may have blinded us to the more subtle role of other possible factors, including brain dysfunction in the rioters who engaged in arson, sniping, and physical assault.

It is important to realize that only a small number of the millions of sium dwellers have taken part in the riots, and that only a sub-fraction of these rioters have indulged in arson, sniping, and assault. Yet, if sium conditions alone determined and initiated riots, why are the vast majority of sium dwellers able to resist the temptations of unrestrained violence? Is there something peculiar about the violent sium dweller that differentiates him from his peaceful neighbor?

There is evidence from several sources...that brain dysfunction related to a focal lesion plays a significant role in the violent and assaultive behavior of thoroughly studied patients. Individuals with electroencephalographic abnormalities in the temporal region have been found to have a much greater frequency of behavioral abnormalities (such as poor impulse control, assaultiveness, and psychosis) than is present in people with

a normal brain wave pattern.(88)

The National Institute of Mental Health (NIMH) awarded \$500,000 to these three modern-day lobotomists to further investigate the use of psychosurgery on "violence-prone individuals".(89)

1969. Arthur R. Jensen, psychology professor at the University of California in Berkeley, received national attention when the Harvard Educational Review published his article "How Much Can We Boost IQ and Scholastic Achievement?" In it Jensen argued against compensatory education and for the hereditability of intelligence. His work included such gems as:

'In the actual race of life, which is not to get ahead, but to get ahead of somebody, the chief determining factor is heredity.' So said Edward L. Thorndike in 1905. Since then, the preponderance of evidence has proved him right...(90)

...It is reported by the National Institute of Neurological Diseases and Blindness, for example, that when all causes of mental retar-

dation that can be reasonably explained in terms of known complications of pregnancy and delivery, brain damage or major gene and chromosomal defects are accounted for, there still remains 75 to 80 percent of the cases who show no such specific causes...(91)

From this and other similar reports Jensen attributed the "mental retardation" to heredity rather than to a culturally and racially biased labeling process (i.e., IQ tests) or to social, economic and racial discrimination--to name a few of the political factors involved in not receiving high scores on IQ tests. (What is inherited is money, class privilege, and white skin privilege.) In fact, Jensen wrote, "There is an increasing realization among students of the psychology of the disadvantaged that the discrepancy in their average performance cannot be completely or directly attributed to discrimination or inequalities in education."(92)

...On the average, Negroes test about 1 standard deviation (15 IQ points) below the average of the white population in IQ.(93)

For many years the criterion for mental retardation was an IQ below 70. In recent years the National Association for Mental Retardation has raised the criterion to an IQ of 85, since an increasing proportion of persons of more than 1 standard deviation below the average in IQ are unable to get along occupationally in today's world...(94)

This latter statement should not be taken lightly. Jensen is talking about increasing the number of people in the U.S. labeled "mentally retarded" from 5 1/2 million to over 37 million, since 2 1/2 percent of the approximately 220,000,000 people in this country score 2 or more standard deviations below the "average IQ" and 17 percent of the population score 1 standard deviation or more below this so-called average rate.

1970. Psychologist James V. McConnell wrote in Psychology Today,

...The day has come when we can combine sensory deprivation with drugs, hypnosis and astute manipulation of reward and punishment to gain almost absolute control over an individual's behavior. It should be possible then to achieve a very rapid and highly effective type of positive brainwashing that would allow us to make dramatic changes in a person's

behavior and personality.... We should reshape society so that we all would be trained from birth to want to do what society wants us to do. We have the techniques now to do it.

...We'd send him [the criminal] to a rehabilitation center where he would undergo positive brainwashing.... We'd probably have to restructure his entire personality....

...No one owns his own personality.... You had no say about what kind of personality you acquired, and there's no reason to believe you should have the right to refuse to acquire a new personality if your old one is anti-social.(95)

1971. The editors of the Philadelphia Inquirer conducted a telephone poll on the question "Should the U.S. Encourage Sterilization among Low IQ Groups?" 69.2 percent of those polled voted in favor of forced sterilization.(96)

Professor Richard Herrnstein of Harvard stated in the Atlantic Monthly,

...the tendency to be unemployed may run in the genes of a family about as certainly as bad teeth.... As the wealth and complexity of human society grow, there will be precipitated out of the mass of humanity a low capacity (intellectual and otherwise) residue that may be unable to master the common occupations, cannot compete for success and achievement, and are most likely to be born to parents who have similarly failed.... The troubles...have already caught the attention of alert social scientists...(who have described) the increasingly chronic lower class in America's central cities.(97)

1972. Arthur Jensen's Genetics and Education was published. In it he wrote, "...the rate of occurrence of mental retardation with IQs below 70 plus all the social, educational, and occupational handicap that this implies, is six to eight times higher in our Negro population than in the rest of the population..."(98)

Nobel prize-winning Professor William Shockley proposed a voluntary* sterilization program in an address before the American Psychological Association. His plan would have the government pay \$1000 for each IQ point below 100 to welfare recipients willing to be sterilized.(99)

1972-1973. Dr. Louis Jolyon West, director of the Neuropsychiatric Institute at the University of California at Los Angeles (U.C.L.A.), proposed to utilize an abandoned Nike missile base for the Center for the Study and Reduction of Violence (CSRV). In a confidential letter to Dr. J.M. Stubblebine, Director of Health in the California Office of Health Planning, West wrote that "Comparative studies could be carried out there, in an isolated but convenient location, of experimental or model programs for the alteration of undesirable behavior."(100) In a secret proposal dated September 1, 1972 West revealed another goal of the Center:

...Now by implanting tiny electrodes deep within the brain...[it] is even possible to record bioelectrical changes in the brain of freely moving subjects, through the use of remote monitoring techniques. They are not yet feasible for large scale screening that might permit detection of a violent episode. A major task of the Center should be to devise such a test...(101)

The Center's subjects were to include "hyperkinetic" children and those with "chromosomal abnormalities":

...a long range study should be instituted to identify children who have this type of genetic abnormality, and to compare their development with that of children who have normal chromosomes.... Such research has great implications, especially with the growing development of means of practical intervention to overcome hereditary defects.(102)

1973. In response to pressure from the gay liberation movement, the American Psychiatric Association eliminated "homosexuality" as a diagnostic category of "mental dis-

* Would it really be a "voluntary" program, when poor people with below-poverty-level incomes are forced by economic necessity to submit to sterilization? The same argument has been made in regard to the all-volunteer army really being one maintained by a "poverty draft."

orders". Judi Chamberlin, an ex-inmate activist, has pointed out that the APA immediately created "a new diagnosis of 'sexual orientation disturbance'...which referred to homosexuals 'who are either disturbed by, in conflict with, or wish to change their sexual orientation.' No comparable diagnostic category was created for heterosexuals who may want to change their sexual orientation."(103)

(Thousands of gays were persecuted and exterminated by the Nazis in the concentration camps.)

Dr. Russell Sacket, author of Florida's "Death With Dignity" bill, said, "Florida has 1,500 mentally retarded and mentally ill patients, 90 percent of whom should be allowed to die."(104)

Cyril Kolocotronis, an inmate at Western State Hospital in Ft. Steilacoom, Washington described the electroshock he had received:

A jolt of power jars you into the darkness of temporary death. It's a darkness you can't see or perceive. It's the equivalent of death, except you wake up again. You wake up upstairs in your cell and they feed you breakfast. It destroys some of the cells in your brain and erases your treasured memory. The war-criminal doctor gives you not one of these, but 15, and one guy got 100!.... And every doctor applying electricity to the flesh knows it harms. His sins are seen by the Skies and by himself. He's worse than an Auschwitz fanatic.

AND NO MATTER WHAT HE TELLS YOU AND WHAT PROPAGANDA HE SPREADS, HE WON'T TAKE SHOCK TREATMENTS HIMSELF OR GIVE THEM TO ANY MEMBERS OF HIS FAMILY.(105)

Peter Breggin reported in an article about psychosurgery.

Minorities will, of course, be the first to suffer. It is no surprise that poor people, the elderly and women were the primary victims of the first wave of lobotomy in the state hospitals. It is no surprise, either, that ghetto rioters were the first concern of the Boston psychosurgeons, that black prisoners and children are among the first victims as psychosurgeons move into prisons and children's institutions, and that women and older people again dominate the statistics in the new wave of psychiatric surgery.(106)

1974. Judge Gerhard A. Gesell stated in a U.S. District Court opinion.

Although Congress has been insistent that all family planning programs function on a purely voluntary basis, there is uncontroverted evidence in the record that minors and other incompetents have been sterilized with federal funds and that an indefinite number of poor people have been improperly coerced into accepting a sterilization operation under the threat that various federally supported welfare benefits would be withdrawn unless they submitted to irreversible sterilization. Patients receiving Medicaid assistance at childbirth are evidently the most frequent targets of this pressure, as the experience of plaintiffs Waters and Walker illustrate. Mrs. Waters was actually refused medical assistance by her attending physician unless she submitted to a tubal ligation after the birth.(107)

Gesell further declared that "Over the last few years, an estimated 100,000 to 150,000 low-income persons have been sterilized annually under federally funded programs."(108) These low-income Americans have, of course, included disproportionate numbers of women, Blacks, Hispanics and people labeled "mentally retarded" and "mentally ill".

1975. Edward O. Wilson's Sociobiology: The New Synthesis was published. Wilson defined sociobiology as "the systemic study of the biological basis of all social behavior."(109) He immediately assumed that the reader would accept the highly questionable claim that social actions have a biological basis rather than a social, political and economic basis, and he went on to declare the

following:

Moderately high heritability has been documented in introversion-extroversion measures, personal tempo, psychomotor and sports activities, neuroticism, dominance, depression, and the tendency toward certain forms of mental illness such as schizophrenia....(110)

The building block of nearly all human

societies is the nuclear family.... The populace of an American industrial city, no less than a band of hunter-gatherers in the Australian desert, is organized around this unit. In both cases the family moves between regional communities, maintaining complex ties with primary kin by means of visits (or telephone calls and letters) and the exchange of gifts. During the day the women and children remain in the residential area while the men forage for game or its symbolic equivalent in the form of barter and money....(111)

Scientists and humanists should consider together the possibility that the time has come for ethics to be removed temporarily from the hands of the philosophers and biologized... (112)

The second contribution of evolutionary sociobiology will be to monitor the genetic basis of social behavior...(113)

1976. Luisa Teish wrote an article in Madness Network News, entitled "That Nigger's Crazy!" warning,

Beware! The labeling hasn't stopped; from 'hostile', 'aggressive', or 'hyperactive' children being given Ritalin to 'anti-social', 'alienated', and 'depressed' Black women being given shock, the story is the same. There is a label and a treatment for 'the Black sickness'. We know that if sanity is defined by white upper-middle class standards then we are in grave danger. It is very easy at this time, when Third World people are seeking their own identities, to say 'That Nigger's Crazy.... LOCK HIM UP.'(114)

R.A. McConnell, Research Professor of Biophysics at the University of Pittsburgh, declared:

I estimate that somewhere between 10 and 30 percent of the U.S.A. population has inadequate genetic endowment to make a net zero or greater economic contribution in a modern industrial society. Or to say it more precisely, this many people are in excess over the possible need for their level of ability. Unless the average genetic competence can be raised, a large (and presently growing) fraction of our people must remain permanently in the

spiritually degrading position of charitable dependence upon the rest of us. This, I believe, is one root cause for our present social malaise. A fortiori [even more certain], a still higher fraction is so restricted by genetic endowment as to be unable to understand many of the intellectually complex issues that are submitted to public vote.

In short, our civilization based on science and technology, which are the creation of a minuscule elite, has grown too complex for the ordinary man.(115)

1979. One hundred ten years after the publishing of Galton's Hereditary Genius, the Repository for Germinal Choice was set up in Escondido, California to "make available the sperm of Nobel Prize winners and other creative, intelligent people."(116) William B. Shockley who won the Nobel prize for physics in 1956 and who proposed a massive sterilization program of the poor in 1972 (See entry in this chronology) was one of the donors to this sperm bank.

The Institute for the Study of Medical Ethics in Los Angeles attacked a proposal by Dr. Saul Krugman of the New York University School of Medicine to inject "retarded" children with an untried experimental vaccine made from the diseased blood of hepatitis victims. Krugman had carried on a similar experiment at Willowbrook State Hospital in 1955. (See this chronology). Carleen Bridgeman, a Registered Nurse and Executive Director of the Institute

said.

Krugman's reasoning that the children would probably contract hepatitis anyway, even if they were not deliberately infected with it, was the same type of justification used by the Nazi doctors in defending their torturous and deadly 'medical experiments' on Jews and other concentration camp victims. It was all right to freeze them, to poison them, to infect them with deadly diseases, to explode their brains, to remove their organs one by one...it was all right because they were going to die anyway. (117)

1980. The New York Times reported that 4000 men, women and children had been sterilized over a 50-year period at the Lynchburg Training School and Hospital to

rid Virginia of "misfits". Dr. K. Ray Nelson, director of this institution (which was formerly called the Virginia State Colony for Epileptics and Feeble-Minded), said that the bulk of the operations had been carried out in the '30s and '40s under the "now-discredited" theory of eugenics in an effort to "raise the intelligence of the people of the state." He also said he felt his predecessors had had "pretty honorable" motives for the sterilizations which were "accepted medical practice for their times."

The Times further reported that 8,300 women had undergone sterilization in Virginia from 1927 to 1972 under a law which still permitted it when doctors thought a "patient" was "afflicted with any hereditary form of mental illness or retardation and the procedure is in the best interest of such patient and society." The Virginia Supreme Court upheld the 1924 law for compulsory sterilization, ruling "It was not to punish but to protect the class of socially inadequate citizens from themselves and to promote the welfare of society by mitigating race degeneracy and raising the average intelligence of the people of the state."

Most of those sterilized at Lynchburg were lied to and told they were having an operation for correction of a medical problem such as an appendectomy. Judy Goldberg, an official for the American Civil Liberties Union, which became involved in a class action suit around the sterilization issue, said that more than 20 states still permitted compulsory sterilization of "incompetent" persons.(118)

The U.S. Government continued to spend enormous amounts of our money researching the so-called biological, psychobiological and genetic causes of human unhappiness and suffering, poverty and unemployment. Just a few of the 1,040 grants given out by the National Institute of Mental Health (NIMH)--amounting to a total of \$98,066,115 --(119) to psychiatrists and other pseudo-scientists on the public dole in fiscal 1980 were the following:

116,534 Joyce G. Small of the Indiana State Department of Mental Health-Larue D. Carter Memorial Hospital (132)

(4)

Project Title	Amount	Recipient
"Psychopharmacology of Major Psychiatric Disorders"	\$307,443	David S. Janowsky of the University of Calif. of San Diego (133)
"Early Drug Evaluation in Neurotic Outpatients"	197,054	Karl M. Rickels of the Univer. of Pennsylvania(134)
"Use of Psychotropic Drugs with the Retarded"	113,711	Robert L. Sprague of the Univer. of Illinois (135)

* See also my interview with psychiatrist Gerhard K. Cotts in Chapter 5. Cotts was clinical director at Lynchburg from 1946-1948 and also "coincidentally" received his M.D. degree in Germany the year the Nazis came to power.

1982. The first baby was born as a result of the insemination of her mother with the sperm of "an eminent mathematician" from the Repository for Germinal Choice, the Nobel sperm bank.(136) (See 1979 of this chronology.)

Against a political background of the highest unemployment (over 10%) since the Depression, union busting and corporate take-backs of workers' wages and benefits, vast cuts in welfare and social security benefits and food stamps, and two to three million homeless people living on the streets of our cities and towns, psychiatry and the government intensified their efforts to suggest a chemical cause for "depression" and other forms of "mental illness". In a typical article entitled "Chemical link found to suicides" it was claimed that "a chemical defect in the brain may be the cause of suicidal tendencies, according to independent studies at three research centers." The centers were the National Institute of Mental Health in Bethesda, Maryland, Karolinska Institute in Stockholm and Wayne State University. Victor Cohn, the author of this article in the Philadelphia Inquirer stated that "the new studies also have found similar abnormalities [chemical defects] and suicidal tendencies among victims of mental disorders and abnormal behavior other than depression." (137)*

Mental Notes, the newsletter of the Berks County Mental Health Association in Pennsylvania, printed under the heading "Mental Health Facts",

32 million Americans (15% of the total population) need some form of mental health services in any one year. Two million of these persons have schizophrenia; two million suffer profound depressive disorders; and more than one million have organic psychoses and other disabling conditions.(138)

1984-1985 (although "1984" does not go away) ...As you are reading this book, psychiatric inmates, elderly residents of nursing homes, "hyperactive" (i.e., full of youthful, rebellious energy) children, "street people", all kinds of "outpatients", "misfits", etc.--you and I and our children, parents, grandparents, sisters and brothers and friends--are being attacked and seriously harmed, some killed, by psychiatry. We are being drugged against our will and not told of the true deadly effects of the drugs. We are being shocked, lobotomized (under new modern names such as cingulotomy and amygdalotomy), and locked up in psychiatric institutions. We are being cooled-out by "talking therapies", "behavior-modified" to fit into the sterile scheme of corporate Amerika (some are being eliminated altogether because that scheme doesn't have a place for all of us) and told that we are "sick", "mentally retarded" and that we are being "helped". There are 20 to 25 million ex-"mental patients" in the U.S. We must continue to build the psychiatric inmates liberation movement. We must join together with each other and with others who understand the oppressive nature of psychiatry and its threat to human freedom and dignity. We must fight back against psychiatric oppression in both its brutal and subtle forms.

* I am convinced--and at one time I tried very hard to believe otherwise by reading a good amount of psychiatric literature--that when there are physiological (i.e., chemical) changes in people's bodies and brains, they are the result of, not the cause of or a justification for such conditions as being incarcerated for long periods in institutions, receiving powerful damaging psychiatric drugs and electroshock, and malnutrition from poverty.

DECLARATION OF PRINCIPLES

1. We oppose involuntary psychiatric intervention including civil commitment and the administration of psychiatric procedures ("treatments") by force or coercion or without informed consent.
2. We oppose involuntary psychiatric intervention because it is an unethical and unconstitutional denial of freedom, due process and the right to be let alone.
3. We oppose involuntary psychiatric intervention because it is a violation of the individual's right to control his or her own soul, mind and body.
4. We oppose forced psychiatric procedures such as drugging, electroshock, psychosurgery, restraints, solitary confinement, and "aversive behavior modification."
5. We oppose forced psychiatric procedures because they humiliate, debilitate, injure, incapacitate and kill people.
6. We oppose forced psychiatric procedures because they are at best quackery and at worst tortures, which can and do cause severe and permanent harm to the total being of people subjected to them.
7. We oppose the psychiatric system because it is inherently tyrannical.
8. We oppose the psychiatric system because it is an extra-legal parallel police force which suppresses cultural and political dissent.
9. We oppose the psychiatric system because it punishes individuals who have had or claim to have had spiritual experiences and invalidates those experiences by defining them as "symptoms" of "mental illness."
10. We oppose the psychiatric system because it uses the trappings of medicine and science to mask the social-control function it serves.
11. We oppose the psychiatric system because it invalidates the real needs of poor people by offering social welfare under the guise of psychiatric "care and treatment."
12. We oppose the psychiatric system because it feeds on the poor and powerless, the elderly, women, children, sexual minorities, people of color and ethnic groups.
13. We oppose the psychiatric system because it creates a stigmatized class of society which is easily oppressed and controlled.
14. We oppose the psychiatric system because its growing influence in education, the prisons, the military, government, industry and medicine threatens to turn society into a psychiatric state made up of two classes: those who impose "treatment" and those who have or are likely to have it imposed on them.
15. We oppose the psychiatric system because it is frighteningly similar to the Inquisition, chattel slavery and the Nazi concentration camps.
16. We oppose the medical model of "mental illness" because it justifies involuntary psychiatric intervention including forced drugging.
17. We oppose the medical model of "mental

illness" because it dupes the public into seeking or accepting "voluntary" treatment by fostering the notion that fundamental human problems, whether personal or social, can be solved by psychiatric/medical means.

18. We oppose the use of psychiatric terms because they substitute jargon for plain English and are fundamentally stigmatizing, demeaning, unscientific, mystifying and superstitious. Examples:

Plain English	<u>Psychiatric Jargon</u>
Psychiatric inmate....	<u>Mental Patient</u>
Psychiatric Institution...	<u>Mental hospital/ mental health center</u>
Psychiatric system....	<u>Mental Health System</u>
Psychiatric procedure. Personal or social difficulties in living.....	<u>Treatment/therapy</u>
Socially undesirable characteristic or trait.....	<u>Mental Illness</u>
Drugs.....	<u>Symptom Medication</u>
Drugging.....	<u>Chemotherapy</u>
Electroshock.....	<u>Electroconvulsive therapy</u>
Anger.....	<u>Hostility</u>
Enthusiasm.....	<u>Mania</u>
Joy.....	<u>Euphoria</u>
Fear.....	<u>Paranoia</u>
Sadness/unhappiness...	<u>Depression</u>
Vision/spiritual experience.....	<u>Hallucination</u>
Non-conformity.....	<u>Schizophrenia</u>
Unpopular belief.....	<u>Delusion</u>
19. We believe that people should have the right to live in any manner or lifestyle they choose.
20. We believe that suicidal thoughts and/or attempts should not be dealt with as a psychiatric or legal issue.
21. We believe that alleged dangerousness, whether to oneself or others, should not be considered grounds for denying personal liberty, and that only proven criminal acts should be the basis for such denial.
22. We believe that persons charged with crimes should be tried for their alleged criminal acts with due process of law, and that psychiatric professionals should not be given expert-witness status in criminal proceedings or courts of law.
23. We believe that there should be no involuntary psychiatric interventions in prisons and that the prison system should be reformed and humanized.
24. We believe that so long as one individual's freedom is unjustly restricted no one is truly free.
25. We believe that the psychiatric system is, in fact, a pacification program controlled by psychiatrists and supported by other mental health professionals, whose chief function is to persuade, threaten or force people into conforming to established norms and values.
26. We believe that the psychiatric system cannot be reformed but must be abolished.
27. We believe that voluntary networks of community alternatives to the psychiatric system should be widely encouraged and supported. Alternatives such as self-help or mutual support groups, advocacy/rights groups, co-op houses, crisis centers and drop-ins should be controlled by the users themselves to serve their needs, while ensuring their freedom, dignity and self-respect.
28. We demand an end to involuntary psychiatric intervention.
29. We demand individual liberty and social justice for everyone.
30. We intend to make these words real and will not rest until we do.(7)

Implant Technology

Implant technology is used to augment existing technology or natural abilities inherent in individual entities. The Andreasson Affair, Part II, shows an excellent portrayal of the employment of crystalline technology.

The most visible example of implant technology in use is the Andreasson Affair, but its use by negative Orion entities seems to be universal within their sphere of influence.

Electronic space societies conditioned to war and destruction found a better way to win conflicts. Wars for territories became wars for the control of minds and entities, since it was learned that massive destruction is counterproductive.

Orion entities (several species of the Greys and the Reptilians) were originally a group of disembodied entities who agreed to have a new "game": forget your immortality, reduce your awareness, and play Survival in the Physical World, which has conquest of the Physical Universe as its objective. After a time, the original players began to encroach upon the universes of others. Thus began an epoch of conquest and domination.

Occasionally, invaders would arrive on a planet targeted for colonization only to discover the presence of a primitive culture that had the potential of having tremendous psionic ability. Sometimes they would find their paths blocked by disembodied entities. They would employ electronic and psionic crystal-based weapons to drive away local denizens.

These disembodied beings were quite capable of arriving at a rapid assessment of the invaders, and they would use their psionic abilities to affect the technology of the invaders.

After a while, invaders would tire of the game, and using their own psionic abilities, they devised the means of trapping these entities. The method involved creating an introversion of attention, which would cause the entity to enter into an organic body. Bodies are vulnerable, and subject to pain and fear. Control was thus established. Bodies are also identifying "tags", each having their own frequency spectrum of output. They also keep entities glued to a linear time track, helpless, unaware and afraid. Bodies are easily controlled and destroyed.

Since the original purpose was the conquest of the physical universe (which implies control of mind and mass-consciousness) it became necessary to create a more equitable system of prediction and control. The practice of implanting came into being as a method of population control. It was and always has been a political expediency.

Games of control are indigenous to the civilizations that came to this sector of space/time. They desired to play out games of separation and negativity that were based on service to Self instead of service to others according to the Law of One.

The purpose of implant technology, which has been around for over 100 million years, is to create a condition in entities of polarity as well as create a condition of judgment and separation between the holistic Self-awareness and the other mind components of the entity, walling these off into separate "selves", each one thinking that it is the only one who is aware and that other beings are to be fought and destroyed.

Through the use of liquid light and holographic crystal-based technology, it became possible to reduce entities (and crystalline structures) to a lower vibrational density, thereby rendering entities less aware and spiritually capable. By programming the various energy bodies around an entity, a series of implants matching the energy field frequency around the specific entity (to prevent rejection) are imposed, thereby allowing polarization and control of the entity.

Since the effectiveness of implantation/programming is finite in nature, it is not (by itself) suitable for control of planetary populations. The implantation/inculcation process is therefore often accompanied by various processes of mass-consciousness erosion by the use of planetary energy grid transmitters to power various other devices used for control.

Religion, sex and pain are the main elements of control over entities "stuck" in organic bodies on Earth. In recent times, the element of "money" was added. All of these elements cause aberration of social structure by inducing fragmentation, which is further used as an element of control in order to keep immortal beings unaware and confused. The concept of "psychology" arises in order to further define what is "acceptable behavior" within a society that already has a unacceptable and destructive structure. Some of the "tools" that have been placed by the Orion structure at the disposal of humans (to control humans for the aliens) are electroshock therapy, lobotomies, and inducement of other mind control disciplines.

Occasionally, an faction which opposes the invaders appears on one of the planets the Orion entities have taken over, in order to free the prisoners. They do this by giving them the technology or information which would make them free beings again. This creates a certain amount of instability in the unstable and unnatural system which has been imposed on the planetary population. This is what is happening on Earth in 1990.

Implants can be physical devices implanted within an organic body. They can also be conditioning patterns that are imposed on ridges occurring in some of the energy bodies surrounding the organic body. Impressions and thoughts can be "keyed in," and control

established over the individual. Implanting and conditioning people is a way of limiting the awareness of that person.

Since implanting is dependent on both electronics and free energy, one of the first elements in setting up control is to establish a planetary power source that can power the implants. On heavy gravity planets, power taps can be established. On lighter gravity planets, Moray-type devices are used in order to step down a resonance of the ambient zero-point free energy.

This is why the energy grid is being rebuilt on the Earth at this time. Planetary realignment and shifting of the axis is vital to energizing the completed grid network. Much information about this network is found in the work of Bruce Cathie, who wrote such works as Harmonic 33.

The Elohim, or Els, (according to some sources), set up implant stations on Earth about 1054AD in order to continue the practice of restimulation of conditioning implants. Locations of these stations are known. Implant stations have been described as metal-walled labs with raised platforms that have an adjustable crystalline table. Some of the tables are solid rectangles which rise up out of the floor and contain various arrays of crystals. Pulsed radiation at specific frequencies is put out through the crystals, knocking out points in the light-body of the human. They can also affect the chakra points.

The main locations of Markabian implant stations are quite hidden from view. Individuals are picked up on death, implanted into forgetting who they are and their past lives, and sent back to pick up a new (prison) body. These particular implant stations are said to be located in the Pyrenees mountains in France, Mongolia, and the Mountains of the Moon in Africa.

A particular vicious implant is the one mentioned in the Andreasson Affair. A tiny particle of plutonium is placed near the pituitary and pineal glands. This knocks out the 'third eye' functions, which allow teleportation, ability to leave one's body, and development of psychic and psionic abilities. The Mayans got around that one by creating a hole in the skull and tying nerve bundles together that would bypass the implant. It is said that much of the Mayan civilization disappeared in one day.

Crystals that are used in this technology are manufactured in space, and are grown in special ELF fields. They must be flawless in order to work properly.

Humans are not generally aware of the "mind cages" and ridge response system in which they are encased. This grants temporary control of what was originally a free being.

The condition of the average being on death is one who is in a deep state of hypnosis. Such beings have been indoctrinated into

RIDGE SYSTEMS AND ENERGY CENTERS

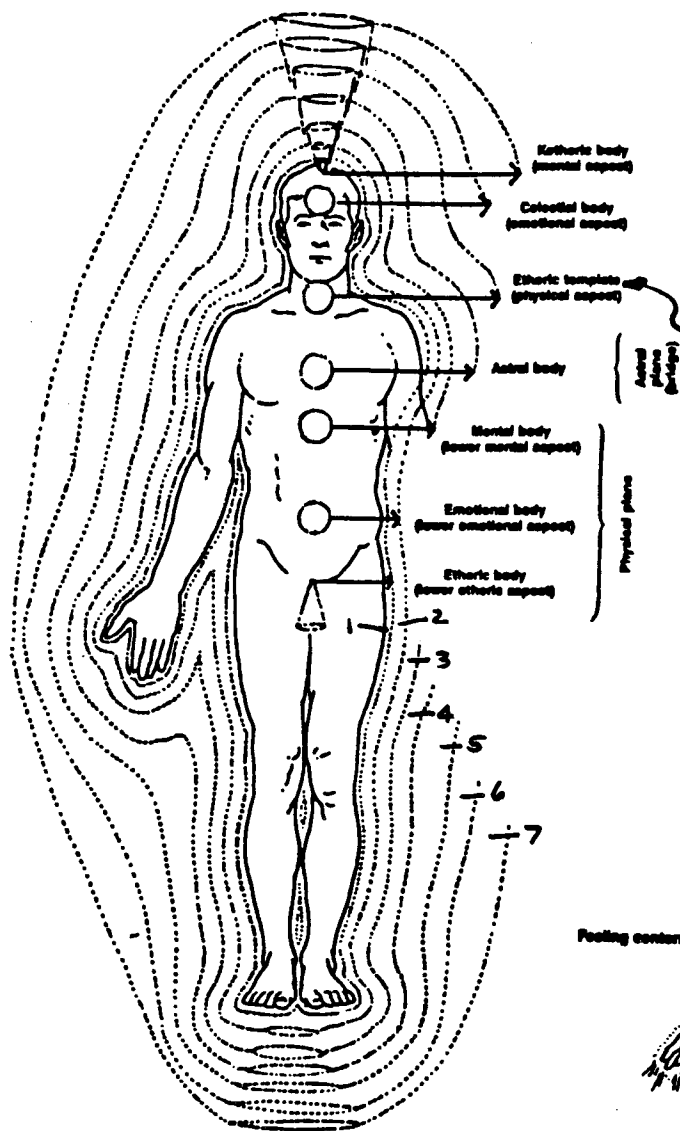

This is the area that is modified by electronic means.

Human Chakra System

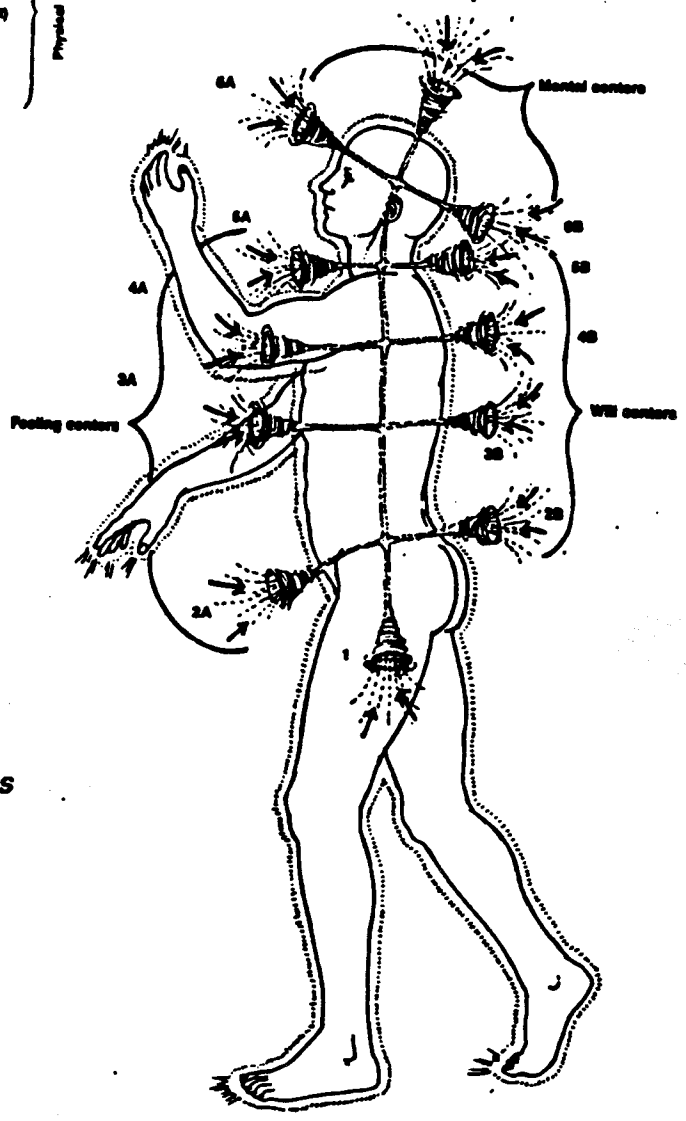

Auric Band Frequency Designations

1. 7.85Hz ELF
2. 15.7 Hz ELF
3. 2.4 KHz VLF
4. 31.6 KHz VLF
5. 392 KHz MF
6. 4.7 MHz HF
7. 54.9 MHz VHF

an automatic response mode after finding oneself as an unaware life unit in contact with a dead body - one goes toward the light to an implant station for a new indoctrination into a future existence "as a body". The standard procedure of alien control over human beings is (1) Death of the organism, (2) Programmed compulsion to report to an implant station, (3) Memory wipe-out, (4) Implantation, and the last one is Assumption, where the genetic entity is knocked out and takes the body at birth. This, in the game, is essentially being like a pawn on a chessboard - one has a "body in pawn".

According to some researchers, a person can have as many as five bodies in this way. There are caste systems which are used in alien societies which would appall the most viciously minded dupe that ever lived on Earth. Many of these systems would be unfrontable by the people of Earth.

Entities are continually being put into human bodies for originally being too powerful, but not quite clever enough, and are put on the cosmic gameboard by beings much less powerful but more cunning. Some beings were just at the wrong place at the right time.

Certain alien groups have gone ahead and essentially created a totally different civilization than the group did who planted humans on this planet. In the past ten thousand years, these alien groups have instituted another decadent, kicked-in-the-head civilization that contains automobiles, business suits, fedora hats, telephones and space ships; quite interesting, but a civilization which looks like an exact duplicate of one which is even worse off. That's why the current U.S. civilization is so restimulative. All these things are the same image. One of the highest crimes you could pull in the Marcab society is to fail to pay your income tax.

No beings of this character who have a system worked out this way (covert slave/prison planet operation) would risk blowing their cover by revealing themselves in a "landing in force" of their space craft. This would "blow their game". All they would have to do is land one ship and they'd feel like the population would go into convulsions, suddenly remembering everything. When you start hitting people with materials of this type, it restimulates amnesia.

The common denominator of indoctrination is obedience to the law and a sense of dutiful cooperation with the group. They prefer the worker, who is content to draw wages and show no other ambition. This leaves the artist, the brilliant engineer, the manager, the genius... ..the criminal.

REICHIAN BASED PROGRAMMING DEVICE
 USED BY ORION ORIENTATION TO
 MANIPULATE HUMAN ABDUCTEES
 (C) 1991 NARG

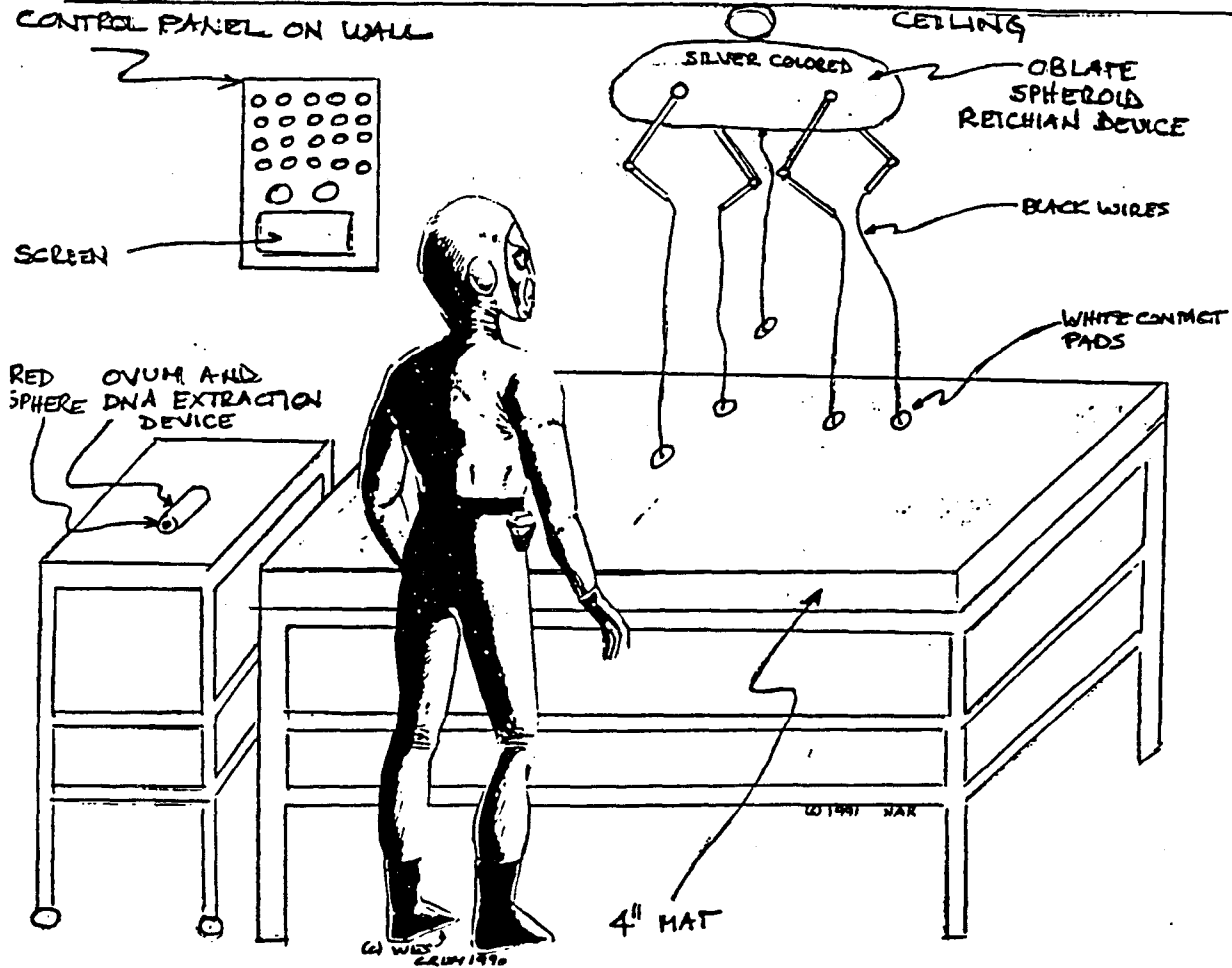

Device using effects similar to that discovered by Wilhelm Reich and his mind control work. It was reported in 1991 by abductee M.P., an artist, who checked the drawing for accuracy. It applies energy fields which keep the human in a pre-orgastic state, which allows mind control and programming to take place. It is often used during sperm and ovum extraction processes, as well as for between-lives programming and memory washing.

MIND MACHINE USED BY THE SIRIANS
TO CREATE ARTIFICIAL REALITIES
IN THE MIND OF THE HUMAN ABDUCTEE
(c) 1991 NARG

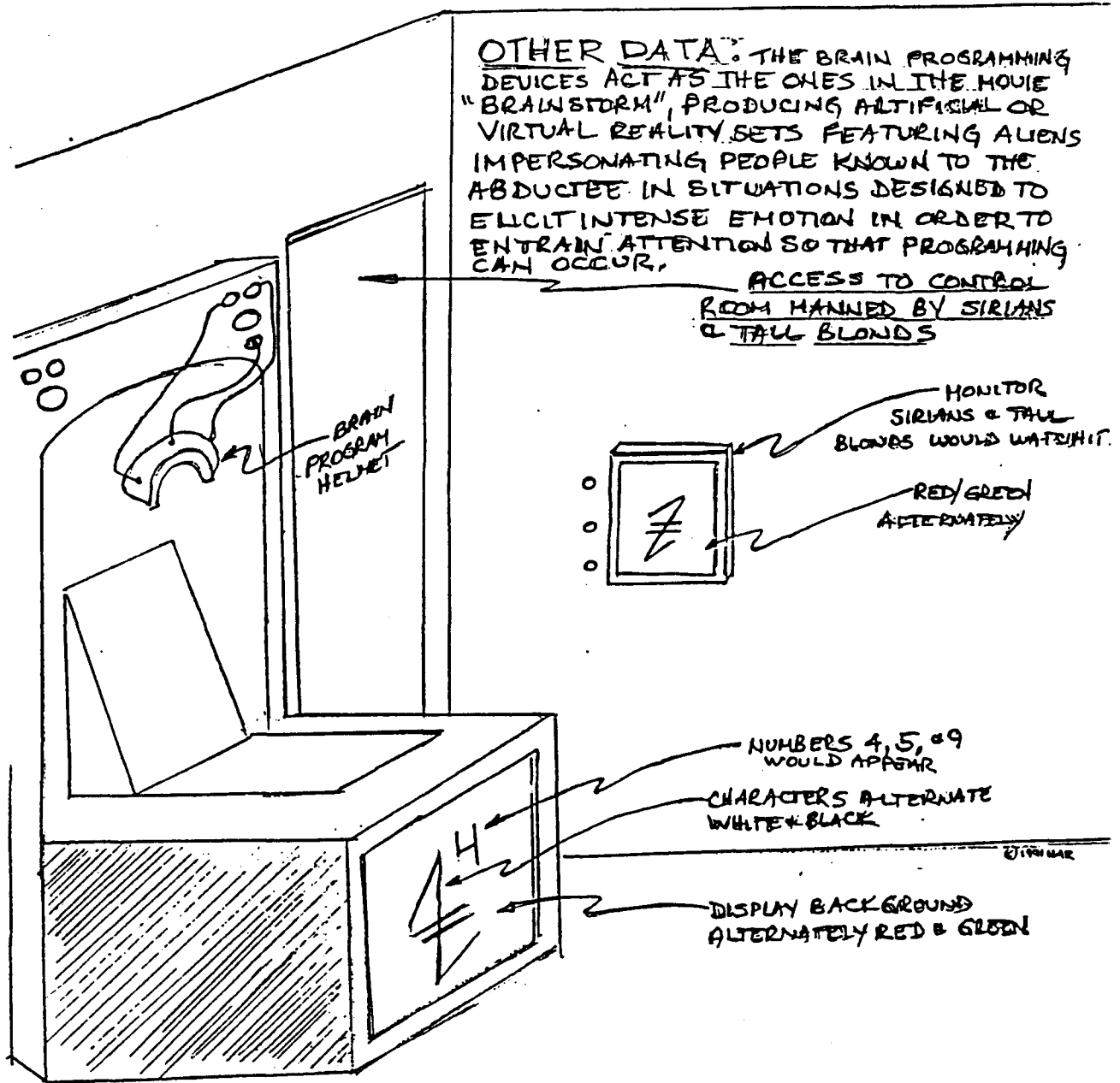

A secondary effect of the process is to make humans think that they are "dreaming", so that they will "relax and let their mind go", allowing alien/government control and programming to take place.

Details On Reichian Programming and Devices

Most people are familiar with the work of Wilhelm Reich only to the extent of his discoveries with Orgone, Bions, Weather Engineering, and his brief sojourn with alien craft as mentioned in his last work, partially written in prison. Coincident with his work on orgone was work done on the pre-orgastic state, which briefly (while maintained) opens up a channel between the conscious and sub-conscious mind, and this allows suggestion or programming to state place during this period. This work was highly classified and access to the governmental research programs which used it was by virtue of the NSA, which also had connections into the Rainbow Projects and the projects done at the facility at Montauk. The original devices used pads which were connected at eight points on the body (the genitals were included). It was discovered through working with an abductee in Las Vegas who had absolutely no knowledge of this that certain alien groups (the negative Sirians) were using equipment on her and others which had a functional operation based on the same principles. It is also known that there were U.S. Government personnel present during some of these sessions, so it has not been determined whether the technology was a parallel development relative to Wilhelm Reich or whether the U.S. had acquired additional similar technology through alien contact after it became aware of Reich's work. It is suspected that both situations may be the case. The significant factor is that the Sirian equipment used pads, because it is known that current equipment (required by the U.S. Government to be kept at any Federally-funded institution) has been generally updated and computerized, and uses tiny little probes 50mm square. They can induce the Reichian state electronically. You can remove buried information in the sub-conscious, reprogram the person, and when the program is over they close it down and restore the person to "normal" with either blocks on memory of the whole thing happening or a total implant of "what went on that day" as a substitute to memory. Using this technique, many of the abductions which are thought to be alien related (many, many of them are alien related) have been actually performed by the U.S. Government with or without their alien allies. Researcher Martin Cannon wrote an excellent piece once on the fact that many of the implants that are discovered (not the spherical ones) were the same as the CIA was using back in the days of Jose Delgado and Company. That again is a good indicator that the U.S. is at work on the sly. As we've always maintained, the difference between what the public perceives as reality and what is really going on is light-years apart. Back in the 1960's, I.T.T. had perfected a series of Super-Luminal Communications Devices which could communicate at 6th and higher orders of energy. These C⁹ devices can communicate across 50,000 light years in a fraction of a second. What good is that, you say? Well, there is mounting evidence that we have had access and communication with places that are light years away for a long, long time on an ongoing basis. Even if you have one of the Psi-Corps NSA Portable Reality Generators, they'll be able to communicate with where ever you go, presumably.

ELECTRONIC MIND CONTROL - E.M.C.

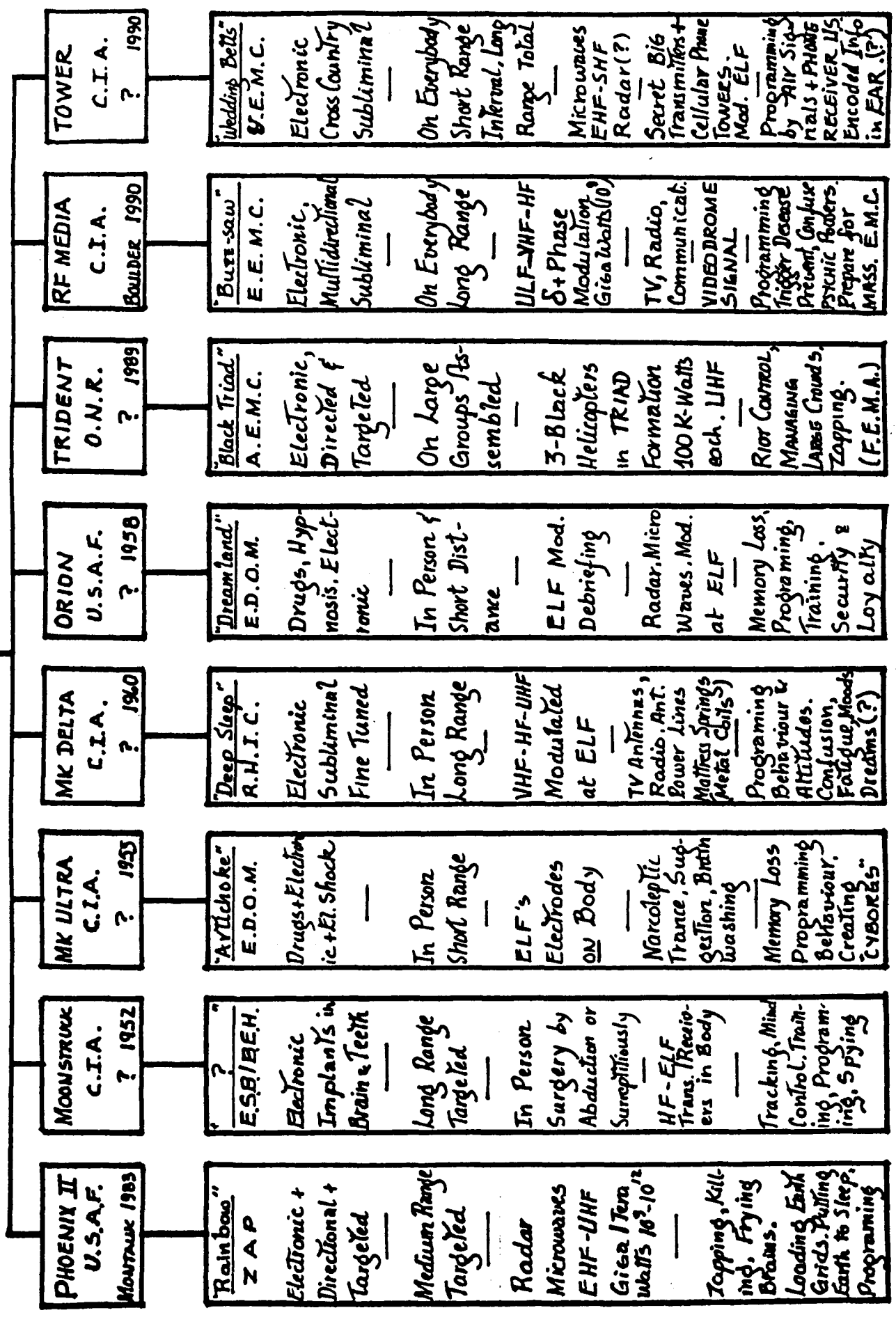

Scientific EMR SPECTRUM (Functional)

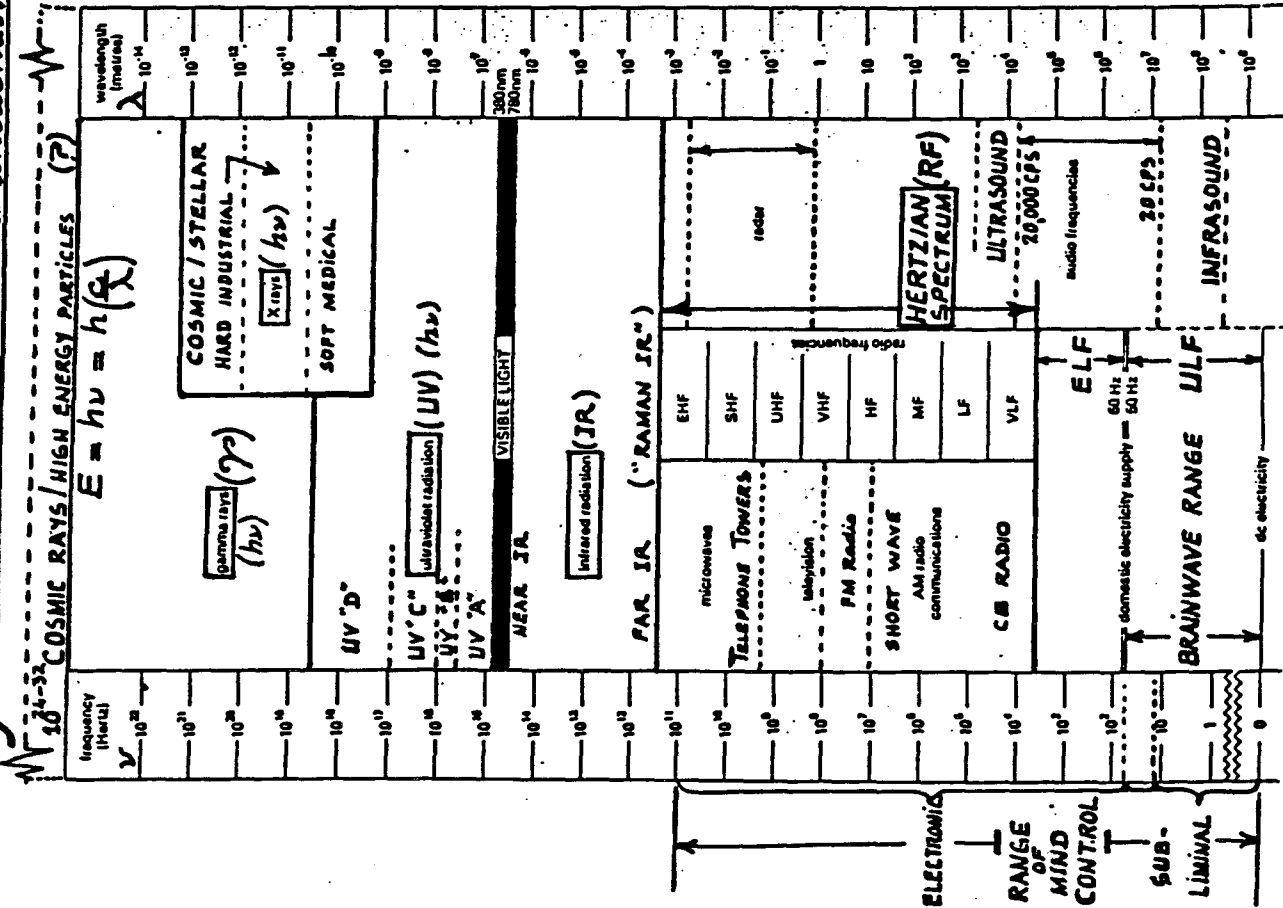

The 3 types of ELF's that exist are:

- (A) Natural ELF's produced by the Earth's Micropulsations, Including Vortex Intersection Pulses (ley Lines) and Geological Fault/Tectonic Pulses. The natural pulse of the earth is the SCHUMAN FREQUENCYs 7.83 CPS. NOTE: The natural pulses of the earth are not Electromagnetic Waves! They are Asymmetric Harmonic Pulsations of Geomagnetic Field.
- (B) Artificial ELF's created by the man-made Electromagnetic Grid. These ELF's are created by Power lines and Electrical Industrial, Office, and Home Appliances. Their penetrating power is directly proportional to their amplitude, that is, their Voltage/Power. They attenuate (decrease) in power inversely as the square of the distance from the source. They do not carry Programmed Information.
- (C) TACTICAL ELF's. These ELF's are created by Television, Radio, Communications and Radar Transmitters/Antennas. The Power transmitted by these devices is usually in the Megawatt (million) or Gigawatt(billion) range. These ELF's can and do carry Programmed Information, are modulated in the 16-20Hz and other "Highly Classified Frequencies", and the carrier waves are in the FM range (147-160), also "Highly Classified Frequencies". Both the type of modulation and "frequency hopping" are also classified, & are intended to penetrate anything, including the ocean and the earth, down to molten central core and bounce back up. Attempts to stop these ELF's using thick-walled Faraday Copper & Steel Cages have been unsuccessful. The only possible solution is to create a neutralizing Pulsating Magnetic Field to counteract the PMF of the ELF's. This type of protective devices are like "Magnetic Domes" or "Spheres", which supposedly is what the Military uses against the Soviet "attacks".

Mathematical and Geometrical Analysis of ELF's: What are they?

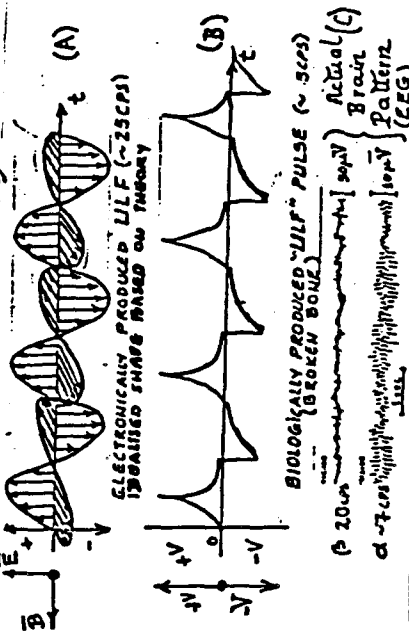

Figs. 10 Patterns of LILF's Measured by ELECTRONIC INSTRUMENTS.

Asymmetrical ELF/LILF are produced by Bio-systems. Symmetrical are produced by Technology & INTERFERES with Bio-Waves.

The Stoppage of Evolution of Mother Earth by Electro-Technology

Loading the Earth: Programming: EINSTEIN-ROSEN BRIDGE "TIME TUNNEL" / HYPERSPACE (ERB-3)

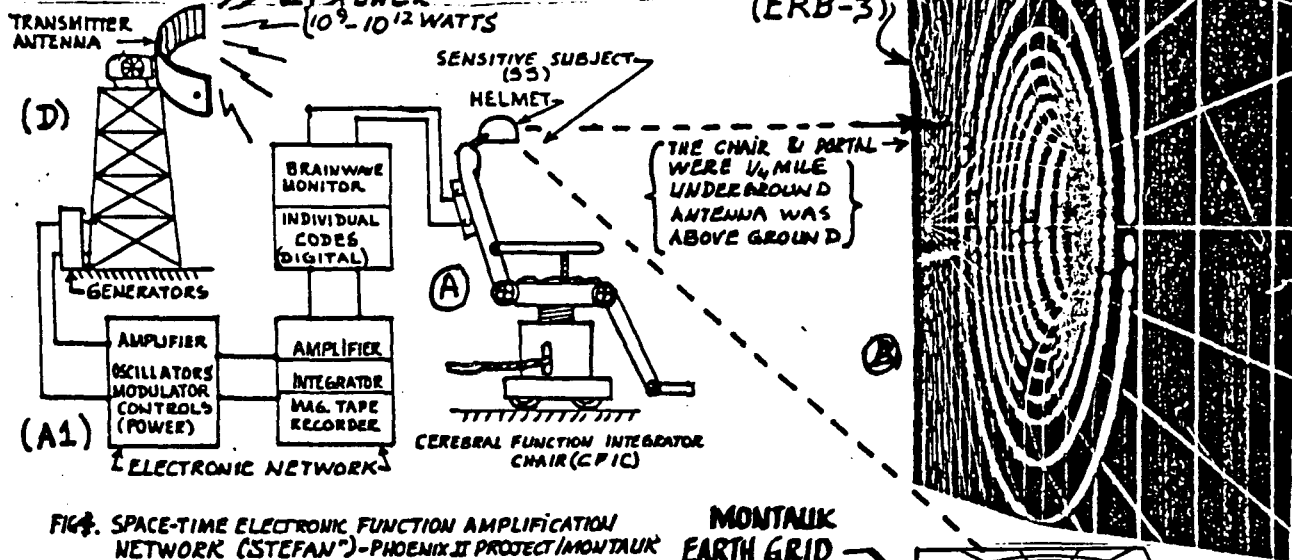

FIG. SPACE-TIME ELECTRONIC FUNCTION AMPLIFICATION NETWORK (STEFAN)-PHOENIX II PROJECT/MONTAUK

MONTAUK PHOENIX II/PHASE III: "STEFAN" PROJECT. Block diagram of the experimental set-up to create an EINSTEIN-ROSEN BRIDGE of the Third Kind (Skew-Symmetrical/Corkscrew/Winding, ERB-3). Sensitive subject is placed in CFIC, stimulated chemically to generate BETA-type Waves, placed in trance by Conditioned Response Altered Consciousness by a Guide to generate ALPHA + THETA-2 with SIGMA PEAKS Brainwaves collected by Helmet. THIS ANALOG SIGNALS are transformed-INDIVIDUAL DIGITAL CODES, amplified, modulated, and Magnetically Recorded. Then the info is fed into the interfacing computers that program the TRANSMITTER ANTENNA, Pulse-modulated Power is radiated by the Transmitter, and the Mentally Synthesized Field Tensor Differential Equations yield the resultant parametric TENSOR FIELD FUNCTIONS specified. And—presto!—the ERB-3 is formed wherever it was specified.

FIG 11 ULF/ELF
Ultra Low Frequency
Range of EMRS
Showing SOUND &
BRAINWAVE ACTIVITY
RANGES for Compar-
ison only. Neither is
part of the EMRS.

TABLE 13.1 THE REGIONS OF THE ELECTROMAGNETIC SPECTRUM AND THEIR BOUNDARIES.

Name	Wavelength, m	Frequency, Hz	Energy, eV
Radio waves	1	3×10^8	1.24×10^{-6}
Microwaves	10^{-3}	3×10^{11}	1.24×10^{-3}
Extreme infrared	15×10^{-4}	2×10^{13}	0.083
Far infrared	8×10^{-4}	5×10^{13}	0.207
Middle infrared	3×10^{-4}	1×10^{14}	0.414
Near infrared	0.75×10^{-4}	4×10^{14}	1.65
Visible	0.4×10^{-4}	7.5×10^{14}	3.1
Ultraviolet	12×10^{-5}	2.4×10^{16}	100
X rays, gamma rays			

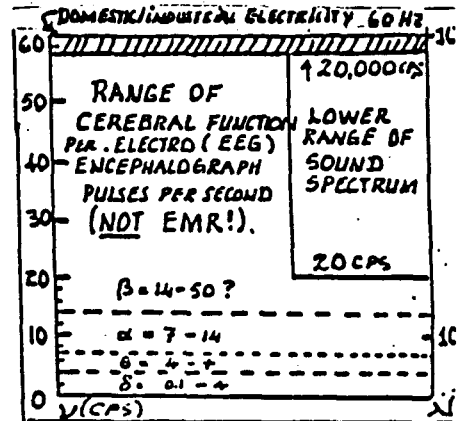

Guess Who gave your Government the TECHNOLOGY used in MIND CONTROL + PROGRAMMING? Guess who?

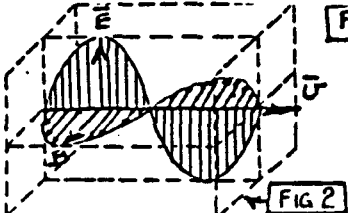
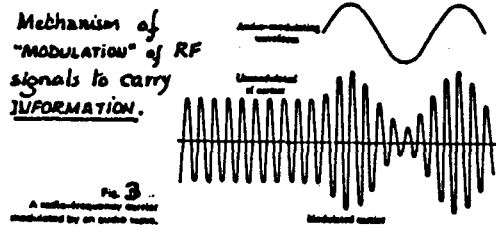
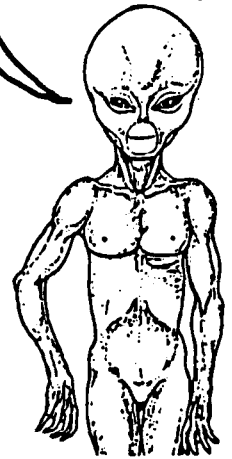

3-Dimensional EMR Waves, "HERTZIAN" EM Waves.
Notice the 3 Orthogonal \vec{E} , \vec{B} & \vec{V} Vectors.
Hz = Cycles per Second (CPS)

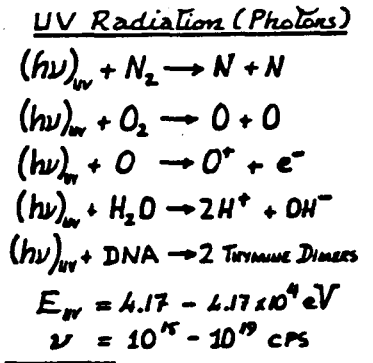

Abductees and Implant Devices

Many of the individuals abducted are implanted with small devices used for monitoring and control. Catscan analysis indicates these devices can be as small as 3mm in size and can be spherical, egg-shaped, or flat. In 1989, the results of interior analysis were released. The interior of a small spherical device revealed a crystalline matrix embedded with what appear to be micro-electronic circuits. Engineering estimates bring the interaction of the device to within quantum ranges, which ties in the function of consciousness modification. Use of implanted devices of a more primitive design was seen in Sweden and Canada around 1967. Implantation of humans with monitoring devices (brain transmitters) was legalized in Sweden in 1973 by Prime Minister Olaf Palme, who was subsequently terminated. Implants have been inserted by military and government intelligence factions of most westernized countries for monitoring and control purposes for both abductees and personnel who work on alien related projects, in order to control and limit the dissemination of information. Use by military and intelligence forces of implants for the purpose of mind control was once limited to Radio-Hypnotic Intracerebral Control and Electronic Dissolution of Memory, but has taken on a more insidious nature with the integration of alien related technology.

Common Implant Sites

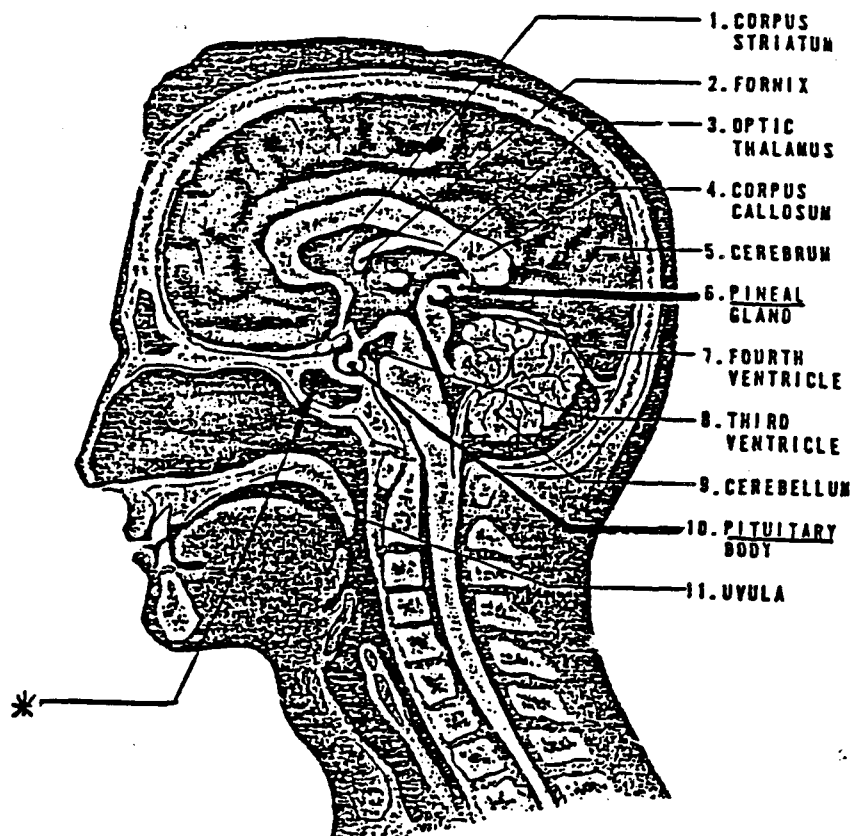

EXTRACT FROM KRILL REPORT NO. 2

**Orion Based Technology, Mind Control
and Other Secret Projects**

**The Spherical Biological Monitoring
and Control Device (SBMCD)**

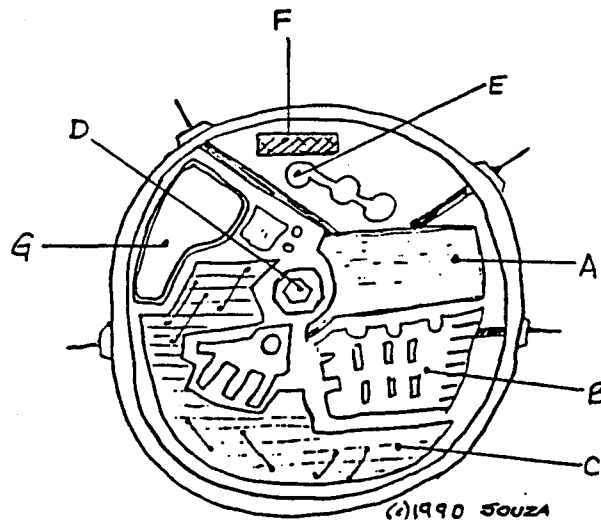

- A - Self-Destruction device; will destroy the SBMCD if access is attempted without frequencies to open 3mm module.
- B - Neural Stimulator. Delivers a phased voltage beam directly into the nerve endings in the brain; cortex-phased transducers on either side of the main lobe oscillate several microvolts of direct current stimulation to the brain.
- C - Auxilliary data storage unit maintains over 10,000 micro silicon wafers, each integrated by direct lead to the micro-positronic simulated brain center, providing instant access to information on call.
- D - Central Power Nucleus. Energy for the unit is generated by the decay of a small amount of Strontium 90, and particles are distributed to the entire unit through a unique direct flow of charged electrons in a fluid nutrient base of a consistency similar to hemoglobin.
- E - Internal/External sensor capable of detecting low photon levels of light energy ranging from UV to IR.
- F - Multiband micro transceiver.
- G - Auditory sensors.



U.F.O. RESEARCH INSTITUTE OF CANADA

24 Hour Reporting Service - News Updates Daily

LORNE GOLDFADER/ DIRECTOR

UFORIC

SUMMER 1991

For information call: (604) 685-1-UFO (836) or write: Dept. 25 - 1665 Robson St., Vancouver, B.C., Canada V6G 3C2

PROJECT I.D. (IMPLANT DETECTION)

WE ARE PLEASED TO ANNOUNCE THE INITIATION OF PROJECT I.D. DUE TO THE LARGE VOLUME OF ABDUCTION ACCOUNTS CONTAINING DESCRIPTIONS OF DEVICES WHICH HAVE ALLEGEDLY BEEN PLACED INSIDE THE BODIES OF WITNESSES AT VARIOUS LOCATIONS, WE HAVE DECIDED TO BEGIN A STUDY THROUGH ELECTRONIC IDENTIFICATION, OF THESE OBJECTS IN ORDER TO DETERMINE THEIR PURPOSE. SEVERAL OF THESE OBJECTS HAVE ALREADY BEEN REMOVED AND ANALYZED BY VARIOUS RESEARCHERS IN THE U.S.A. - SO WE CAN ASSUME THAT IT WOULD BE FAIR TO SURMISE THAT THERE IS SOME FORM OF PHYSICAL INTRUSION TAKING PLACE. CIRCUMSTANTIAL EVIDENCE BY RESEARCHERS SUCH AS BUDD HOPKINS REVEALS NUMEROUS OCCASIONS WHERE SCAR MARKS AND INCISIONS HAVE BEEN FOUND. AUDITORY AND VISUAL PERCEPTIVE INTERFERENCE HAS BEEN DOCUMENTED IN IMPLANT PHENOMENON RESEARCH. SOME PIONEER RESEARCH IS NOW BEGINNING IN THE CIVILIAN COMMUNITY TO COMMUNICATE AND INTERACT WITH THESE DEVICES. WE HAVE NOTED SUCH RESEARCH, BOTH PUBLISHED AND UNPUBLISHED AND HAVE DECIDED TO CONDUCT OUR OWN INDEPENDENT STUDIES. FOLLOWING OUR CODE OF ETHICS (SECTION "C"/MEDICAL - AVAILABLE ON REQUEST), WE WILL OBTAIN VOLUNTEER PERMISSION WITHOUT COERCION FROM THE ABDUCTEE COMMUNITY, SO THAT WE MAY HAVE TEST SUBJECTS. DISCUSSIONS WILL TAKE PLACE AS TO CO - OPERATIVE METHODS & PURPOSE, AND GUIDELINES DESIGNATED. ALL PROCEDURES WILL BE NON MEDICAL, NON INTRUSIVE AND ACCORDING TO CIVILIAN SAFETY STANDARDS. IF AND WHEN MEDICAL PROCEDURES SUCH AS CAT OR MRI SCAN ARE REQUIRED, A PHYSICIAN WHO IS QUALIFIED IN SUCH A FIELD OF EXPERTISE WILL BE CONSULTED.

INITIAL GOALS OF PROJECT "I.D." :

- (1) MHZ./GHZ. DETECTION OF IMPLANT FREQUENCIES & THE ACCOMPANYING CARRIER WAVE FREQUENCY.
- (2) DISRUPTION OF THE SIGNAL AND RECORDING OF RESPONSES TO THE GENTLE INTENTIONAL INTERFERENCE (BIOLOGICAL & PARANORMAL REACTIONS).
- (3) MEANINGFUL INTERPRETATION OF DATA ENCODED INTO THE TRANSMISSIONS, AND INTERACTIVE RESPONSE EXPERIMENTATIONS TO THE INFORMATION SO CONTAINED.
- (4) LATER INVOLVEMENT IN THE PROJECT OF A NEUROLOGIST, IF & WHEN WE HAVE ACHIEVED #'S 1 - 3, WITH DOCUMENTATION, AND ELECTRONICALLY RECORDED EVIDENCE. COMPUTER EVALUATION/GRAPH CHARTS.
- (5) DOUBLE BIND STUDIES.

ASSISTING US WILL BE ONE OR MORE ELECTRONICS ENGINEERS. WE HAVE ACHIEVED SO FAR IN IDENTIFYING SEVERAL FREQUENCIES - HOWEVER THEY TEND TO FLUCTUATE DUE TO MANY VARIABLE FACTORS OUTSIDE A CONTROLLED LABORATORY ENVIRONMENT. RESULTS WILL BE PUBLISHED UPON COMPLETION OF THE PROJECT OR IF A MAJOR DISCOVERY ENSUES. THE ONLY EXCEPTION TO THIS CASE WILL BE IF INFORMATION IS RECEIVED WHICH WOULD ENDANGER THE NATIONAL SECURITY OF THIS COUNTRY OR IT'S ALLIES.

ALL FREQUENCY RECORDS WILL BE SECURED IN BANK DRAWER AWAY FROM INSTITUTE UNTIL PUBLICATION OF RESULTS ARE RELEASED TO THE PUBLIC.

ALIEN MANIPULATION NETWORKS

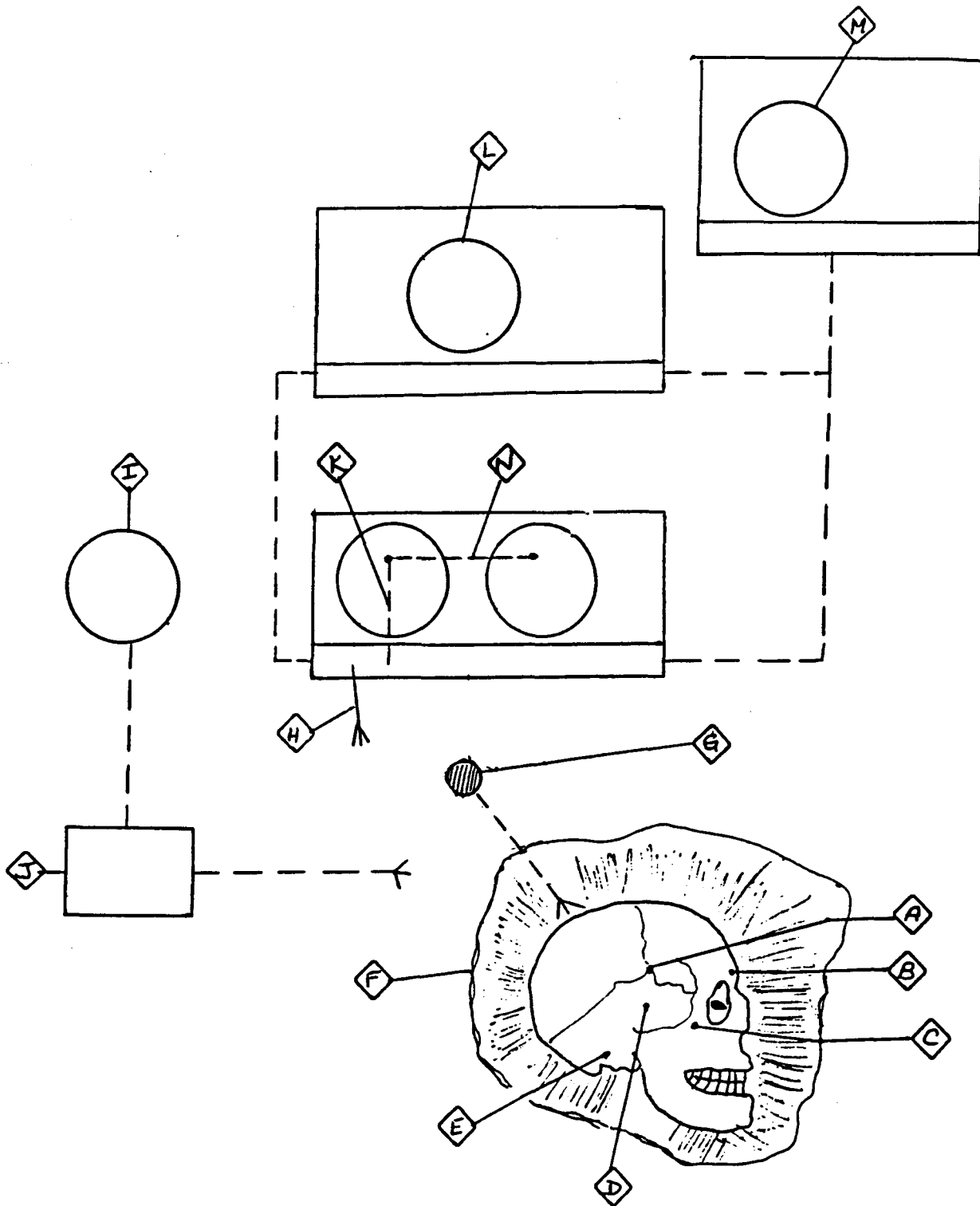

Key To Alien Manipulation Network Diagram

- A : Pineal implant site.
- B: Forehead implant site.
- C: Nasal / Pitutary implant site.
- D: Cochlear implant site.
- E: Brainstem implant site.
- F: Energy field around head.
- G: Alien implant monitor. Device exists outside physical visual spectrum. Can be sensed by some sensitive humans. Amplification device for data interchange with alien equipment at a remote location.
- H: Alien computers and sensory equipment.
- I: Symbol representing the factions in the government that monitor abductees. Superiors of agent-handler program, NSA and CIA.
- J: Government monitoring of implant for location, suggestion and control.
- K: Grey 4 1/2 foot clones, whose awareness is mechanical and restricted. Biological entities all move in unison. Maintain "hive-mind" structure. Although there are periods when a group of them on a disk will divide the tasks of the whole amongst themselves, there are occasions when some of them are idle while others are occupied. The idle ones often repeat the body movements of the non-idle ones. For example, one of them would raise his right hand and the right hand of several of the others would move up a bit. These are relatively weak beings who need group support and could not survive without the relative superiority of their technology. They are always manipulated by a higher caste of Grey, a human or a humanoid. These aliens have communicated the phrase "we are in bondage".
- L: Higher caste Grey species monitoring the 'K' computers and include the group awareness of 'K' within their own.
- M: Reptilian/Draconian species monitoring 'L' and "K' computers and entities.

On 1985. I got contact for R. Naeslund who is a victim of Swedish brain-research. This yellow leaf is compiled from information R. Naeslund and his friends have gathered.

BRAIN TRANSMITTER

Device which stream through the brain with a frequency that picks up the sensory functions of the brain by means of a transmitted wavelength, which is transmitted to a receiver. Vision, thoughts, images, hearing, etc are completely obvious to the person who has the receiver connected to his head. Vision can even be transmitted to a screen. The eyes of the person with an installed brain transmitter function in this case the equivalent of the lens of a camera.

The brain transmitter is the size of about half of a cigarette filter. The shell is manufactured of optical fibre, and the contents of liquid chrystals.

The brain transmitter is inserted into the head through the nose.

During its first experimental period the brain transmitter was implanted in patients under general or local anesthesia during hospital operations. The police began to use brain transmitters around 1972.

During the early 70's, the police instigated illegal use of brain transmitters. People under arrest and in detention were anaesthetized by mixing somnisiacients in food and drink. The apparatus was then inserted.

A doctor at one of the larger hospitals in Stockholm has also mentioned that young children were also used for these experiments in order to evaluate thought activity and reactions in children.

According to information from a person close to Department Head Falkenstam at The National Swedish Police Board, Swedish Prime Minister Palme gave the police the right in 1973 to insert brain transmitters into the heads of human beings.

It has been verified by people in official positions that the brain transmitter is used both in the Soviet Union and the United States, as well as in countries such as Sweden.

One of the brain transmitter centre in Sweden is known to be located at the police headquarter at Kungsholmen, Stockholm.

Some of the victims of Swedish brain-manipulation are dead , some alive. According Robert Naeslund the last victim who died was Edward Kelly. He died for cancer on 28. May 1985.

United Nations Centre of Human Rights, Chief for communications unit, Jacob T.H. Möller answered on 14th August for a complaint made for Swedish government illegal use of braintransmitters: " I regret having to inform you that the United Nations cannot be of any assistance to you in the matter which you have raised."

With the exception of a few free newspapers , Swedish media have exercised total silence about the matter.

July 27, 1983

Mr. Robert Naeslund
Ervallakroken 27
S-12443 Bandhagen
SWEDEN

Dear Mr. Naeslund:

In response to your most recent letter regarding the roentgen films I can only confirm that some foreign objects, most likely brain transmitters, have been implanted at the base of your frontal brain and in the skull.

The risk of such implantations is considerable and the risk of chronic infections and meningitis when the implantation has been made through the nose or the sinuses are real issues.

In my opinion, there is no excuse for such implantations if the patient has not been fully informed about the procedures, the purposes, the risks, the method of anesthesia, etc. and then gives a clear written consent.

* I fully agree with Lincoln Lawrence, who in his book on page 27 wrote: "There are two particularly dreadful procedures which have been developed. Those working and playing with them secretly call them R.H.I.C. and E.D.O.M.--Radio-Hypnotic Intracerebral Control and Electronic Dissolution of Memory."

Many years ago I had some discussions with Delgado. He asked me to apply my ultrasonic technique for his particular purpose of altering patient's behavior but I declined because we had entirely different aims and approaches. However, I found Delgado to be an intelligent but somewhat strange man.

Best wishes!



P. A. Lindstrom, M.D.

*

Lincoln Lawrence: WERE WE CONTROLLED, The Assassination of President Kennedy
New York, 1967

PAL/mjt

Robert Naeslund is one of the victims of Swedish brain-research. On 15th January 1985 Robert Naeslund and 49 other people send a petition to Magnus Sjöberg, the Director of Public Prosecutions of Sweden. The 49 people who had signed the petition varied from professor of physics to journalists and human right activists. In petition they demanded investigation about braintransmitters that are implanted in heads of people without their knowledge and consent.

The director of public prosecutions who haven't earlier answered Robert Naeslund's letters didn't answered this time either. His subordinate, Chief Prosecutor Jonny Järnefelt made his decision after 3 months waiting that there is no reason to believe that crime which may lead legal action has been committed and therefore no investigation will be made.

This in spite of three professors testimony that certifies presence of strange foreign objects in Robert Naeslund's skull.

The Leader-Post Regina, Saskatchewan Saturday, December 13, 1980

Five Canadians suing CIA over experiments in 1950s

VANCOUVER (CP) — Robert Logie says he was a guinea pig for the United States Central Intelligence Agency, and constantly relives a nightmare of hospital brainwashing sessions that included hallucinogenic injections and massive electric shocks.

He and four other Canadians launched a \$5 million suit this week in Washington against the U.S. government. They are claiming \$1 million each in damages from what they say was a CIA-funded multi-million-dollar research experiment into the behavior of drug-induced patients.

Logie, a 42-year-old reclusive bachelor, said in an interview his troubles are connected to Montreal hospital LSD experiments he was subjected to in the late 50s.

He says he now is an introvert, often depressed and unable to work. He is afraid of crowds and suffers severe memory lapses.

Needs pills

He says he is dependent on pills to slow down his heart, to reduce tension and anxiety and to help him block out the recurring nightmares of his two visits to the Allan Memorial Hospital in 1956 and 1957.

Others involved in the suit are Val Orlikow, wife of MP David Orlikow (NDP-Winnipeg North), Jean-Charles Page of St. Andre-Ext., Que., Jeanne Huard and Lillian Stadler of Montreal.

"I had 14 injections of the LSD," he said. "After I had treatments which put me out for 23 days. I still have nightmares."

He says he sees the late Dr. Ewen Cameron, then chairman of the psychiatry department and director of the Allan Memorial Institute at McGill University in Montreal, "coming at me with a huge needle filled with the LSD injection."

"I was afraid, nervous, uncomfortable in his company. I pleaded with my parents, 'please take me out of here, they are giving me a horrible, horrible drug.' But my parents believed the doctor knew best."

The suit claims that Cameron, who left Allan Memorial in 1964 and died three years later, administered electric shock treatments 75 to 100 times normal dosages to patients while they listened to taped messages hour after hour. The petition also says some patients were drugged to induce sleep for more than

a week to make them forget their behavior was artificially programmed.

Was guinea pig

Logie says he was a "human guinea pig" for a CIA drug experiment program called MKULTRA Sub Project 68, one of a series of CIA-sponsored schemes to test interrogation, behavior control and brainwashing.

He said the CIA paid Cameron at least \$50,000 to conduct the mind-control experiments and an additional \$35,000 went to McGill in the form of grants to the psychiatry department.

Logie said a U.S. agency called the Society for the Investigation of Human Ecology was a front organization for the CIA program.

Logie said he arrived here in 1968 with no knowledge of who he was or where he was.

He said he slept under a bridge for five nights before going to the police. A Vancouver relative identified him after a newspaper printed his photograph.

"I don't know if my amnesia is related to the LSD experiments," he said. "All I know is that the nightmare never stops."

Friends

I know what I am about to tell you will sound bizarre, almost beyond belief--RCMP surreptitious testing of a telepathic amplifier that works with microwaves to control people's minds and bodies, voices in the air, spy schools, interrogation, toxic gas--I know how crazy it all sounds.

I know your first reaction will likely be to dismiss me as some kind of "kook" who has sadly lost touch with reality.

I know if I hadn't been victimized by this "experimentation" I would probably react the same way. But I am asking you not to.

I am asking you to take a few minutes to read through this pamphlet, to think about other things we all know have happened that tested our belief and trust in those in charge of our society, to reflect on the story I have to tell and finally, to give me the benefit of your doubt.

For, if there is, in your mind, the slightest chance what I have to tell holds some truth, doesn't it demand and deserve your further concern?

I know my story sounds like the plot from some low budget science fiction spy thriller that could never happen in real life. The problem is it did happen in my life. And it could happen in yours if you don't join me in my battle today to expose and resist this attack on human dignity.

I may have been one of the first victims of this sinister program; but, without your help, you can be sure I will not be the last victim.

Martti Koski
January 1981
Ottawa

My story

IN THE BEGINNING I simply thought I was slowly going mad. I knew it wasn't normal to hear "voices" and mine were with me for two to three hours every day. I felt they came at me through the ceiling from the suite above me.

But, I wasn't really worried. I had resigned myself to the thought I was suffering from some sort of neurotic disorder--impossible to get rid of, but harmless enough. Then, in the late summer of 1979, after four years of this "talk", things suddenly got a lot worse.

I seemed to lose control of most of my normal body functions and emotions. It was as if someone or something could control my sleep, my sense of smell and taste. Food was, by turns, made to taste very salty or acidic. Sexual functions, urination, bowel movements and basic metabolism--all were affected.

Finally, I couldn't even work. I'm a welder and I came to be unable to breathe in any air contaminated with carbon dioxide. It made me salivate excessively and foam at the mouth.

By now "the voices" were with me 24 hours a day. I was being talked to every waking hour. I was allowed minimal sleep--about an hour a day. If I left my apartment I immediately became very drowsy, yet indoors I could not sleep.

My heartbeat became erratic and finally uncontrollable. In December, 1979 I was admitted to the University of Alberta Hospital in Edmonton, the victim of a "heart attack".

It was in the hospital I first suspected I was the victim of something more sinister than my body's own normal reaction to physical or emotional illness.

FOR THE FIRST TIME the "voice" identified itself. It told me it was a spokesman for the RCMP and that I had been selected for "training" as a spy. The first phase of my training would be to learn how to survive in a Russian insane asylum. The hospital would serve as my training ground.

I remained in the hospital for three days, the subject of many bizarre and strange encounters and experiments. In one instance, I was given medication but simultaneously warned by "the voice" not to take it as it was poisoned. When I did take it, I suffered heart palpitations.

I was warned not to go into a certain room. But I was later lured into it by a "doctor" and then subjected to interrogation and a battery of "tests" related to sexual functions and organs.

The interrogation began with an electric shock being applied to my penis. Then the telepathic talk of the voice encouraged me to masturbate to avoid becoming impotent. But, I was unable to achieve ejaculation.

The "voice" warned me if I failed to ejaculate I would suffer extreme consequences: my scrotum would become elongated and I would have to be operated on. When I left this interrogation room and went back to my hospital room, the old man sharing it with me exposed himself to me, revealing a scrotum about 15 centimetres long.

These kind of sexual and genital "experiments" carried on throughout my whole time in the hospital.

During my time in the hospital I was also unable to sleep due to severe headaches that seemed to be induced each time I attempted to sleep.

When I left the hospital I returned to my apartment. But, I soon again experienced problems with my breathing and extreme headaches. I decided to flee my home to seek release from the problems that were hounding me.

I STAYED AWAY from my apartment for 10 days, living in cheap hotels--but I was not left alone. My sleep continued to be disrupted; by bladder ruptured twice because I had somehow lost the ability to sense the need to urinate.

I decided to look for help again at the hospital. But it was the same as the first time--it was still a "spy school" where I was "in training".

This time the "training" involved stealing shirts and engaging in a kind of black market where cigarettes were used to "buy" services from other patients (inmates).

As in my first experience, some of the doctors and some patients participated in the play-acting to create the impression of a Russian insane asylum. One doctor I remember by name was Dr. Peter Hayes.

I returned to my apartment. But was, one morning soon after, awakened by a phone call from someone who hung up as soon as I answered. Immediately gas poured into my room for about 15 seconds causing my mouth to fill with blood. Then "the voice" told me this was my last warning.

Afraid for both my sanity and my life I decided to return to my native Finland, a decision that was to convince me, more than ever, of the RCMP intrusion into and takeover of my life.

IN ORDER TO LEAVE Canada I would need my passport; but, when I went to look for it, I couldn't find it. I had apparently misplaced it. I decided to leave Canada from Toronto where I could also apply for a new passport.

I travelled to Toronto by Greyhound bus pursued all the while by "the voices". On this trip I noticed a marked RCMP car seemed to be following the bus for several hours. And several times the bus was met by RCMP cars and people who I took to work for the RCMP left the car to ride on the bus and vice versa.

It was also on this bus trip that I got the first hint of the kind of experimentation I was being subjected to: the voices began to call me the "Microwave Man". And all the while the "spy training" exercises continued.

Among other things:

*I was told what food to eat and what food was dangerous. If I ate forbidden food I suffered severe heartburn and feverishness;

*the voices told me I needn't worry about my credit card spending as my line of credit had been extended to unlimited.

*I was given my first "assignment" (to find out the population of Toronto and then how many men and how many women);

*my voices became Finnish-speaking, female voices.

THINGS IN FINLAND were no better than they had been in Canada. The "voices" clung to me. The one change was they now identified themselves as being from the star Sirius.

The experiments and voices carried on for the whole two and one half months I stayed in Finland.

I believe my mother was at last somehow convinced to aid the authorities. She confessed to me, just before

my departure, she had placed prescription drugs I had no need of in my luggage. Part of a plan to induce another "heart attack"?

My return journey to Canada by ship, train and plane took over five days and nights, during which time I was not allowed to sleep at all.

BACK HOME IN EDMONTON
The strange occurrences piled themselves one on another. First, I found my wayward passport on my kitchen table.

Next I was subjected to several toxic gas experiments. It seemed to me now other tenants in the building were either agents of the RCMP or co-operating with the police force in their experiments.

In an elaborate and excruciating experiment that involved hypnosis and supporting special effects employing fire trucks circling around me I was presented with a program of indoctrination to convince me criticism of the American society was a "cancer" and a threat to us all. I was told I was "unclean" and "contaminated" with this "cancer". The fire trucks were to be used in a massive cleansing or washing away of the contagion.

My ability to withstand this heavy physical and psychological bombardment was at its breaking point--and then I chanced on a way to begin to resist.

BY NOW IT WAS EARLY APRIL.

The days were warming up. I discovered the power of the micro-waves were lessened in the open air. I was even able to sleep out on the grass in the sunshine. This sleep--the first true sleep I had in months--was enough for me to begin to rebuild my will to resist the forces at work against me.

As soon as I began to resist--with measures described in the following--the experimentation began to ease off.

I still hear the Finnish "voices", but the "talk" is less intensive. They call this stage "custody."

But my fear for my health and life continues. (At one point the "voices" told me my ultimate fate will be to suffer a "natural" death in five years.)

And, my worries about what is in store for the entire Canadian society continues.

Why me?

Why was I chosen as a test subject? Is there something special about me that singles me out for this kind of attack, or is it simply that "they" are out to get me.

The answer is: "Yes and no." Yes, they are out to get me. And no, I am not special in any way that is out of the ordinary. No more than you are or somebody you know perhaps. I just happen to fit a set of characteristics that would make anyone a likely subject.

I am single. I live alone. My only relative in Canada lives thousands of miles from me. I do not belong to any fraternal groups, organizations or political parties. I have difficulty communicating with other Canadians because of my poor spoken English. In short, an ideal target: I don't have a large circle of acquaintances and my ability to reach out and make new contact is limited.

Moreover, I believe the preparation time--in my case four years--is designed to reinforce this isolation, to promote "strange" behaviour and to discourage, even further, friendships or contacts.

Fighting back

I began my struggle to expose what was happening to me by posting handbills on telephone poles and the boardings around construction sites throughout Edmonton. The posters accused the RCMP of making me a telepathic amplifier that works with microwaves". I asked others who feared they too might have been caught in such "experiments" to contact me....several did...I was not alone. Half of the people who contacted me said they had been subjected to this experimentation when in prison.

In an effort to place my predicament before more people I wrote letters to the daily newspapers. None was ever printed. (The Edmonton Sun did however, later carry a "news" item casually dismissing and denigrating my accusations and efforts to defend myself.)

In May, 1980 I wrote a four page letter to the Finnish ambassador outlining my whole ordeal. I have never even received an acknowledgment that my letter was received.

I laid my concerns before the city police and government agencies such as the Alberta Human Rights Commission and the Alberta Law Enforcement Board. None investigated the matter.

The Alberta Human Rights Commission informed me the matter was beyond their responsibilities as there was no racial discrimination involved.

The Alberta Law Enforcement Commission at first "lost" my letter of complaint. After several visits over a period of two months Mr. R. Smith, a commission employee, promised: "I'll see what I can do". The next day I got a visit from RCMP Corporal G.A. Forbes.

Forbes began his "investigation" by asking my permission to request my medical records--records I was never allowed to see myself. I gave permission and I assume Forbes saw my records. At any rate, he contacted me again and said he intended to investigate further. I never heard from him again.

By July and August of 1980 I was more determined than ever to put my revelations before the public. I composed a five page leaflet setting out everything that is included here and distributed 16,000 of them throughout Edmonton.

Again I got several responses from people who claimed to have been victimized as I was and am. But there was no reaction from the news media or any official body.

And, of course, I wrote my MP. Again, no response.

I came to Ottawa, the nation's capital, the place where the "the buck stops", in early December of 1980 resolved to spend the little money I have saved in one final attempt to get people to pay attention to this problem.

The pamphlet you are reading now will be the last thing I can do. I have kept back only enough money to return to Finland.

My life depends on you!

**AN ATTEMPT TO SPEAK OUT TO
SAVE MYSELF BEFORE IT'S TOO
LATE FOR ME AND FOR ALL OF US.**

WINNIPEG, 1952 Agencies of the Canadian government co-operate with the United States Air Force in "experiments" in biological warfare involving the aerial spraying of contaminants over the entire city of Winnipeg.

MONTREAL, 1958 Doctors at McGill University use their patients as unknowing "human guinea pigs" in CIA-funded experiments with LSD.

TORONTO 1979 The RCMP admit to deliberately falsifying the medical records of political activist Ross Dowson. The police distribute false reports of Dowson's mental instability to discredit him with his followers.

TODAY Martti Koski, a Finnish immigrant in Canada believes he has been targeted by the RCMP as the latest "guinea pig" in bizarre experiments in mind control and "telepathic terrorism" using microwaves.

These few examples represent just a tiny portion of the whole range of "dirty tricks" by authorities that have come to light in recent years. But, even a complete list of what we know would be limited because it would only be a list of what we know. What we don't know must be the real concern. And as Martti Koski's story reveals, what we don't know is probably hurting us.

I would be glad of any contact with anyone who has fears they have been similarly victimized or who is just concerned others may have been.

PLEASE CONTACT

I have moved back to Finland.
They are still continuing experimenting.

MARTTI KOSKI
Kiiilinpellontie 2
21290 RUSKO
FINLAND

«We have known the letters but the whole thing is best ignored». (Spokesman of RCMP about my story, Edmonton Sun August 10.1980).
In spite of people efforts RCMP has ignored all the demands for a rational investigation.

HOW TO HELP!

If the leaders of Canadian parliament had NOT known the crimes I have explained my booklet, they would have arranged an investigation that had covered also RCMP's and army's secret files and saved the reputation of Canadian legal standard.

The members of the cabinet try to avoid a whole case. They use police and army authorities as disposable workgloves for their criminal activities. Similarly as Josef Stalin, Richard Nixon and lately Ronald Reagan, they are ready to explain for public that they had been totally unaware of crimes that high police or army officers had organized.

If you want to help me, please write to any member of the Canadian Parliament or the Canadian Prime Minister (address: House of Commons, Ottawa). Ask them to use their powers to restore justice for country, and arrange an public investigation for my case. That investigation should cover also army and police secret files. If you get any answer I should be very happy to know what their response is.

You help me also if you:

- A. **Distribute this Information.** Give this pamphlet to someone else after you have read it. better still, copy it as many times as you can and pass out those copies. Unlike most publications, this one may reproduced, stored or transmitted free. That more people will read this, that more people become aware and cat.
- B. **Investigate my charges.** Perhaps you have contacts that can uncover more details of those things that have happened when policeforce had closed their eyes. - It was a couple of investigating journalists who arranged me a contact to Robert Naeslund, victim of Swedish brain-research who got a listening device removed his brain by surgery. Unfortunately no large newspaper printed their story. Unlike is told, the free press, democratic society's «watchdog», barks only when the owner of the dog asks it to bark.



PROGRESS RECORD (Typewriter Copy)

Patient Identifier

Source

Request Date

TO WHOM IT MAY CONCERN:

Recently I reviewed a skull film marked: MASLUND, ROBERT and dated 26-11, 1961. That film shows a couple of unusual foreign bodies at the base of the skull, possibly some form of brain transmitters.

However, I have not examined or talked to this patient and do not know the pertinent history.

San Diego, CA
October 6, 1983

Joyona Wickborn

Ingemar Wickborn, M.D.
Professor of Radiology
U. C. S. D.

181-178 10-788 SRC 808

Lab Report Regarding Analysis of the Implant

Mätning 8 på Nicolete AB, Åkersberga

Datum: 9 juni 1983

SE BIFOGADE DIAGRAM

16 000 Hz, modulerad frekvens

25 200 Hz, modulerad frekvens

32 600 Hz, modulerad frekvens

Testapparat: Nicolets Radiofrekvens Analys Dator

Sändare: Försvarets Långvågssändare

Närvarande: Elektroing Ove Larsson

Rolf Gustavsson

OBS

Vid detta tillfälle då jag icke deltar, finns heller icke de frekvenser som vid varje tillfälle tidigare har uppmätts, möjliga att uppmäta. Utan endast de vilka sannolikt går in i Rolf Gustavssons huvud. Vilka är andra våglängder.

An analysis of Implant Triggering Frequencies

6.740 m V 25.2000 KHZ

316.2 m FS

ISPEC A
LG, LN LIVE

SINGLE DSP
.1

80 dB MN

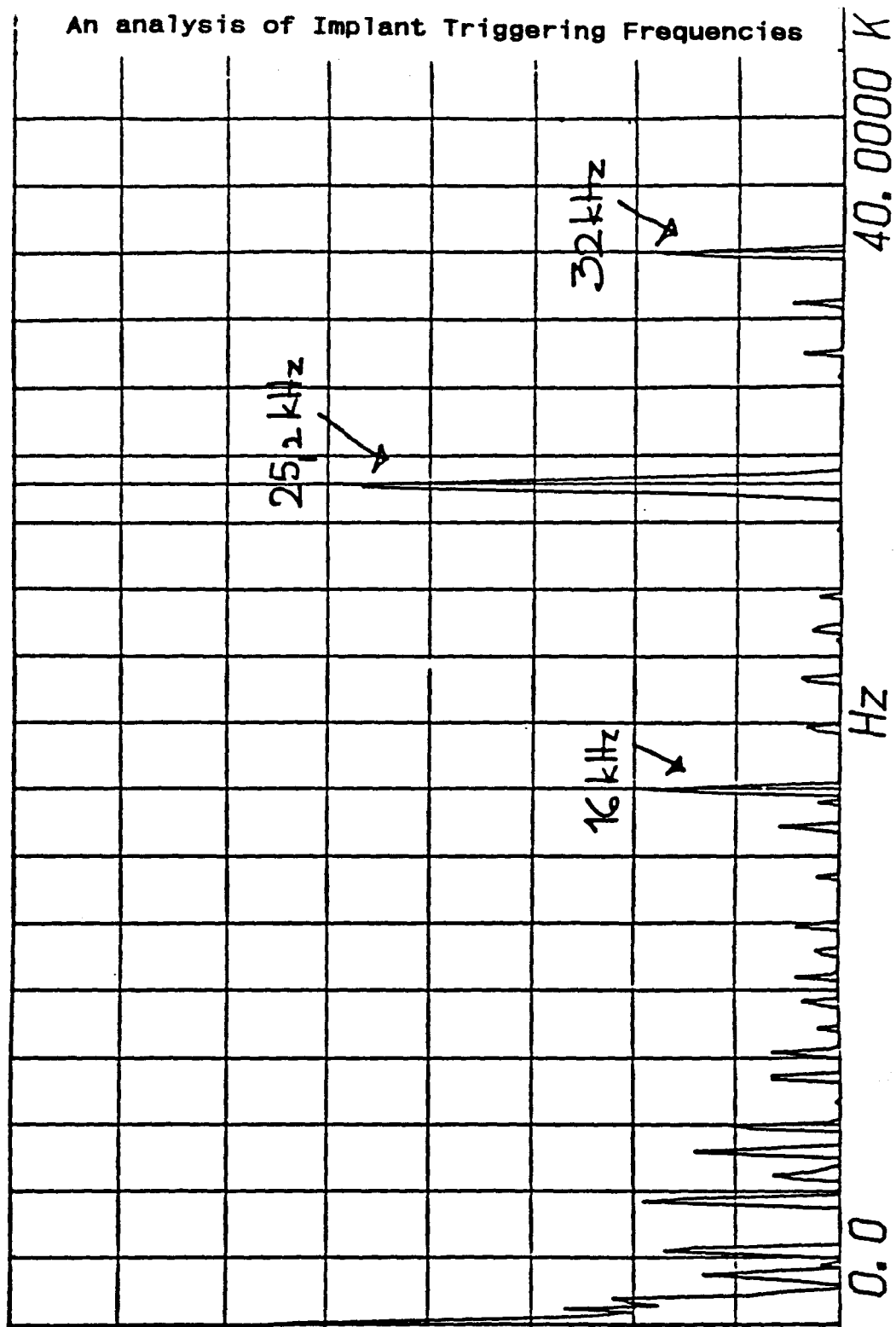

A: 50 mV A C AT 1.000 V/V

I know you have done very valuable work in helping people who suffer through the mental health system, so I am sending you this letter.

You can read my story in the booklet MY LIFE DEPENDS ON YOU. Inside this booklet is a yellow leaflet that has the main results of research by R. Naeslund and his friends. R. Naeslund had to leave Sweden because the police made his life very difficult. I lost contact for him while he was outside Sweden and Don't know what has happened for him.

I want to make clear braintransmitters do exist in real life, doctors took them out of R. Naeslund's brain in 1978.

Military and political leaders want to keep braintransmitters out of public knowledge. In secret it gives them easy control over political movements they want to discourage. Another thing is that development of these weapons is continuing and publicity would make research involving criminal human experiments difficult and risky. It would reveal the participation in, and support of military and political leaders, for these kinds of crime.

The members of the cabinet, Solicitor-General and others responsible for experiments in Canada, don't publicly deny the existence of the crimes I have explained. They avoid the question. In their language they are exercising "the right to maintain silence". This at the very same time as innocent people are being tortured and propably killed in secret human experiments.

I have estimated that hundreds of people - maybe over a thousand - have lost their lives as victims of electrical mind-control experiments. For practical and economic reasons people who have got braintransmitters inserted their heads are likely to be experimented on until they die from the damage of their experiments.

The most likely places where the experiments started were jails, in the army, hospitals and mental institutions.

Some members of your organisation could be or could have been victims of electrical mind manipulation experiments. Also somebody could know a person who is a victim of these experiments. So I hope you will distribute this information among your members by copying my booklet or reproducing it in any other form you prefer.

If anybody feels he is a victim of brainmanipulation, I want him to contact me. I can't help them now, but I would record their names and stories so that in the event of investigation, experimenters cannot conceal the victims of their crimes.

It would help my case if you would contact the canadian government and ask for an honest investigation to (secret) information Canadian Army and RCMP has in my case. R. Naeslund's case helps if you similarly contact Swedish government. If you get any answer I should be bery happy to know what their response is.

I wish you a happy and active year in 1987. Yours:

Martti Koski
Kiilinpellont. 2
21290 Rusko
FINLAND

INCULCATION DEVICES AND PRACTICE
OF ELECTRONIC MANIPULATION OF
THE MIND

Learning, Teaching and Assimilation Techniques
of Electronic Space Societies

Through the experience of those who have had and continue to have various contact with non-human entities, we have learned some data regarding these advanced societies. Overall, life appears to be rather regimented - social codes are sufficiently advanced beyond those of the human being that they become a part of existence rather than the subject of existence.

In electronic space societies of positive orientation, knowledge and data are generally assimilated under duress, in that training and education are accomplished by forceful means, such as implant technology. Inculcation (to teach or impress by force or frequent repetition) is the usual term used.

One of the prime patterns of activity is what is called direct observation. During this process, face to face contact occurs between the alien species and a volunteer humanoid for the purpose of exchanging cultural information. Direct observation also appears to include various types of medical analysis. Abductees in this situation are actually volunteers, but inculcation methods block their knowing or awareness of their own participation.

Direct Observance Operational Procedures

- * A human target being is sensed.
- * The humans Ridge Response System¹ is examined and checked.
- * The craft is allowed to appear to the human, releasing old implant blocks.
- * Subject is monitored and picked up when appropriate.

Sometimes a targeted being will be picked up in childhood and taken to an underground facility for crystal implantation. They will be monitored through the growth period. In young adulthood, the being is picked up, the crystals removed, and the being is "parked in reserve" for future triggering and employment. The Andreasson Affair is an excellent case which features these elements.

Inculcation Devices

Several kinds of devices have been noted by those who have had contact with these various species.

The Inculcation Bar: A rectangular metal box with multi-colored lights displaying a the sequence of blue-green-red-green-blue and the numerical sequence of 1-2-3-4-5-4-3-2-1. The subject lies on his back on a metal table directly beneath the bar. At the foot of the table level with the surface is a metal console box with cables connecting to the table. The attendents are dressed in red jumpsuits, and the room itself is bathed in red light, except when inculcation therapy is in progress.

The Inculcation Monitor: This monitor, when coupled with the data banks in the ships computers, can be used to implement the enhancement of a being by infusing abilities through implantation of data. During this process, it appears as if negative mental states are removed and mental barriers are set aside. The monitor is a modulated catecholamine encoded laser beam, which pierces the eyeball of the abductee in a nano-second. It resonates down compatible optic frequencies, which sets up harmonic vibrations which disseminate the encoding to the proper receptor sites.

Catecholamine Beta-Lipotropin 4753: Technical name for substance often given to abductees. It has the effect of removing certain body blocks and at the same time gives a boost to the awareness/intelligence level of the abductee. It is a mixture and distillation of slightly enkephalamic melanocyte-stimulating adrenocorticotrophic hormone in a neural metastasizing, neurotransmitting medium; i.e., a cerebral cortex 'roto-roter'.

Rapid Inculcation Processes

In one method, one dons a helmet bearing wires and needles. A crystal cube is put into a niche on top and a strobe light flashes in resonance with the brainwaves of the abductee. The abductees head becomes filled with pictures which gradually form a pattern of response. The abductee is given a learned motion-pattern-response system, and may be trained in a brief amount of time to do a complicated task.

Sometimes the abductee is hypnotized or made to sleep and a high frequency microwave emission is used as a carrier wave with which to send encoded data into his nerve/ridge-response system. This data can be triggered later by a pre-arranged stimulus-response signal that will be present in the environment of the abductee.

Sometimes the bioenergetic field itself is used as a carrier wave, and the data is encoded in sound-code-symbols or symbols in facsimile2 form.

The Grey hybrids known as the Reticulans have an interesting variation in which the abductee sits in front of a screen and computer console and interacts with images on the holographic display.

Notes

1. Ridge Response System: A series of energy focal points formed by energy streams around the physical body. Ridges can impinge on each other and cause an enduring state. Ridges exist in suspension around the human, and are the foundation upon which facsimiles are built.
2. Facsimile: A facsimile is a recording of all perceptions, effort, thought and emotion experienced by the organism during any one point in time. It is recorded by the reactive mind³. A facsimile can also be considered the physical universes impression on thought, specifically that section of thought which has a physical universe impression with a time tag on it.
3. Reactive Mind: Portion of the mind which works on a stimulus-response basis, which is not under conscious control, and which exerts force and the power of command over the beings awareness, purposes, thoughts, body and actions. The reactive mind never stops operating. What is thought to be unconsciousness is always conscious.



Associative/Cognitive Memory

Associative memory is where the bits of experience in daily existence are processed, encoded, and linked with similar bits of memory for later retrieval. This memory process involves recognition, retention, and recall. Recognition involves sensory pickup, Retention is determined by attention and involves processes that occur in two subcortical structures called the amygdala and the hippocampus, with actual storage occurring within the cortex and other sub-cortical structures. Retrieval is determined by accessing that huge storage network using a variety of associations, linkages and configurations that tap neural representations of similarly stored associations, linkages and configurations. This is the memory involved during reminiscing, reading, learning, writing, and "thinking".

How is information entered into the memory system? The average capacity of human short-term memory is about 7 bits of data. Sometimes these bits of data are linked together in the mind as "chunks" so that longer assemblies of them can be remembered. Short term memories may last as long as several minutes. Special attention is required in order that it be preserved in longterm memory. That special attention may be repetition or the use of mnemonic devices. Entering information into longterm storage requires complex circuitry involving the two sites at the amygdala and hippocampus. The amygdala has a special function of linking emotional tone and memory together and is especially important in processing memories with a strong emotional component - like abduction by alien entities. Application of discrete energies to this region may be one of the processes involved in burying memories within the abductee.

Non-cognitive Memory

Information is entered into this type of memory through different neural circuitry than is used in the associative memory. It involves the more primitive subcortical basal ganglia structures. It is more of a system of conditioned reflexes than of conscious memory. Learning in this system is an automatic, conditioned response predicated on reinforcement of that response. What is actually stored is not neural representations, but the changing probability that a given stimulus will evoke a specific response due to the reinforcement processes that are occurring at the time. Phylogenetically, this memory structure evolved before the cortex process. It is essentially "memory without consciousness". Usage of these areas as sites of implantation is well documented, and is probably connected to manipulation of the individual through the bioelectrical fields in the ridge response system, where a stimulus in the environment (seeing a disk or another element outside 'normal' reality) provides an automatic reject response or a response in physiological processes which appears totally inconsistent with the stimulus.

Conversations with
An Alien Species
(c) 1990 N.A.R.

Communication with a varying group of aliens described as seven foot Greys was established in September 1988, and was maintained as a research project up until 1989, when it was decided to analyze the data that we had . These aliens exist at a different density level than do the Greys that are involved in the abduction of humans, and have a more holistic viewpoint. During the year or more that contact was maintained, a lot of information was gained about other species of entities. A lot of information was also gained about the nature of reality structure. One central entity seemed to function as the focal point for the alien group. Information was derived from areas that the whole group had access to, and questions were directed in such a way that we might glean as much as possible about how alien thought process that these entities had, and also how they viewed the situation here on Earth during this time period. The central entity chose the name Kirok for us to use, since they do not have names as we know them. Kirok and a group of alien beings, sometimes as many as 19 of them, decided to establish contact with us as a growing experience for both sides. Some of the material follows:

X: What is the purpose for the abductions and mutilations done by some alien species?

K: It is part of the natural process...

X: Explain this natural process

K: All experience is chosen by participants.

X: Participants? Does this apply to the work that Whitley Streiber is doing?

K: Yes

X: Would you care to comment on what is happening now with the aliens, the different governments on earth? How do you see this from your viewpoint?

K: There are many paths of probabilities. All scenarios will happen that people conceive of.

X: Are you saying that we will continue to create reality out of existing situations?

K: Yes

X: Does Kirok perform a function in your society?

K: He is the one who stretches reality.

X: Is the Earth scheduled for geological upheaval?

K: That is possible. The upheaval would be severe for some and not for others. Most will perceive changes.

X: What is the ultimate cause of this?

K: Agreements are made by the Whole with Itself...regarding its own evolution.

X: Are you aware of a group called the Network?

K: Yes. This is a group formed in a military manner.

X: From what origin does this group come?

K: From different origins.

X: Are they for the Many or for the Individual?

K: Ultimately they are for the Law of One.

X: There is another group allegedly called the Confederation.

K: This group is much larger than the first.

X: What is their orientation?

K: They exercise what they perceive to be control over others.

X: Are they for the individual or for the group?

K: They work both together and against each other.

X: There is another group which is allegedly called the Interdimensional Association of Free Worlds. Would you comment on that?

K: This has to do with influence that is somewhat removed from our levels.

X: Tell us more

K: I cannot determine the reason for the influence of the third group.

X: There is supposedly another group called the Federation.

K: This one is linked through your own governments.

X: There are several groups called Greys. Where do they come from, Zeta Reticuli?

K: They come from within the whole Orion system.



H Y B R I D C H I L D

This is a very accurate representation of a hybrid between human and Grey genetics. Females, as this one, have hair. Males do not.

Hybrid children between Reptilian and human genetics have green-yellow eyes with vertical pupils and do not look as "human" as this female.

X: Preceding the Essessani?

K: Yes

X: The Essessani are our children, in essence?

X: There is a situation where within a two or three cycles of our sun, it has been said that there is a great grouping of beings coming this way. What is the purpose for this group to come here?

K: Its purpose is survival.

X: Their survival?

K: Yes

X: What of us?

K: You will be easy for them to deal with.

X: Is their origin Alpha Draconis?

K: We do not know.

X: Do you know about the Draco?

K: Yes. Their intentions are survival.

X: Are they a negative group?

K: They are different from you.

X: Are humans meant to assist them?

K: Probably not at this level...you are too different.

X: There have been comments amongst some that would indicate that this planet is hollow. Is this true?

K: There is more to it than the surface, yes.

X: Are you aware of the interactions between a Federation and the United States Government?

K: No, not beyond...the government has...all the major governments have information...contact with ...non-resident beings.

X: Do they have contact with the Network?

K: We do not know.

X: Is our higher self just another term for consciousness as it blends back into the Universal Mind from whence it arose and within which it is sustained?

- K: There is much more to your higher self ...to your self...than consciousness. Consciousness will evolve until it encompasses more and more of the self, and then more and more of the family, then more and more of the race.
- X: We estimate the brain development of the dolphin to be 65 million years ahead of human brain development, that they are a more advanced species than humans, and that they are trying to get a message of some sort to humans. Would you comment on this?
- K: They have chosen a different line of experience. Part of their motivation is to preserve the planet that houses the physical expression of themselves. Their consciousness is spread evenly over the individual and the family groupings.
- X: And also their hive-souls?
- K: Yes
- X: When consciousness withdraws from the physical bodies of cats, birds, and other non-human species....it is out understanding that the experience that has accumulated while in this place is brought to a group species pool to be shared in a holographic manner by all of the species. Is this true?
- K: Yes, but it also occurred during the life of the animal.
- X: Then the different experiences serve to strengthen specific thoughtforms to do with these experiences within the group species specific pool.
- K: I am not sure what you mean.
- X: There was an instance in a place we call England. We use gratings...holes...across traveled ways for some animals. They perceive the grating to be of infinite depth and they do not cross. At one point, at one location, animals we call sheep began rolling across the grating to get to the other side. All of a sudden, the same thing was happening in other areas.
- K: This demonstrates that the experience goes into what you would call the collective consciousness before death. The sheep were testing themselves.
- X: Some groupings of individuals on this planet continue to impose a system of limitations on others. Comment?
- K: This can only continue as long as it is allowed. There are no victims. Only participants.
- X: Does this limitation retard evolution?
- K: It does not retard evolution. It does for the individual what

the individual will allow it to. The individual can use socially imposed limitation in any number of ways, or the individual would not have chosen to experience it.

X: Some species, during a natural process, implant crystalline electronic devices in human beings. Comment?

K: For more or less the same purpose that human beings implant or apply such devices to other lifeforms.

X: Are they for monitoring or control?

K: More monitoring than control.

X: Tracking?

K: Yes

X: For continuation of genetic research?

K: Yes, and the study of humans.

X: Toward what end? Blending?

K: Yes

X: What groupings? The Greys?

K: Yes

X: There are other groupings...

K: There are several others that study humans in this way.

X: Would you comment on races with blond hair?

K: They are also involved in this.

X: During these genetic experiments, there are different reasonings for the genetic experiments, depending on who is doing them. Comment?

K: You refer to them as experiments. This is not correct. They are doing work beyond the experimental stage.

X: During one of the autopsies that was performed by humans on an exteriorized being after a crash, it was noticed that the area of the brain we term the associative cortex had a crystalline network in it. Comment on the network.

K: In some societies, the linking is forced. The group will force it upon itself. You would call this control of one or one group of individuals over another or another group. These individuals like to call it discipline, guidance, or foundation.

"Total Recall"—Paul Verhoeven directs this thriller set on Earth and Mars in the year 2075, with Arnold Schwarzenegger as a man who discovers that his entire life was programmed and implanted in his brain; he must go to the Red Planet to find out who he really is. (Tri-Star/Carolco) 1990

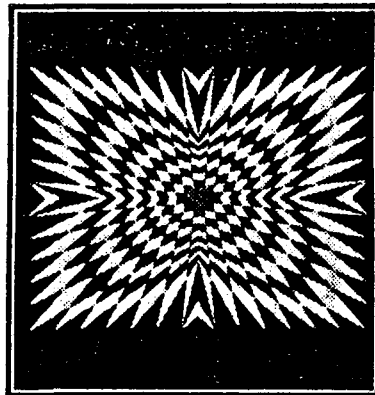

X: That depends on ones perspective.

K: Perspective of the one involved.

X: Is group awareness a disadvantage in that sometimes a thing that would affect one would affect all, as opposed to species with verbal communication.

K: Misunderstanding between individuals in a group does not occur. An event occurs to an individual. It will only affect other individuals as far as the other individuals allow it to affect them. The effect and the awareness are two different things.

X: We choose our own effects.

K: They are chosen for a reason.

X: Does the reason have to do with agreements?

K: All is done by agreement.

X: The concepts of space and time. Comment?

K: These definitions are used by many entities. They are placed upon themselves in order to expand beyond them.

X: Where are you from?

K: I am from your future.

X: How far in the future in our terms?

K: More than 2,000 years.

X: Do you inhabit this planet?

K: Sometimes

X: Have you physically interacted with our civilization?

K: I have not. Members of my group have.

X: Have they interacted with the Pleadians?

K: Yes

X: In the future, what relationship do our future selves have with the Pleadians?

K: You are of the same family. When you have reached racial awareness, you will be one with them again.

X: What is your relationship with the Pleadians?

K: We are descended from the same roots.

X: Are you familiar with a civilization from a place we call Maldek?

K: Yes. We are descended in part from them.

X: Can you tell us what civilizations have used the Earth's Moon?

K: All civilizations that interact with Earth inhabitants.

X: Are you familiar with the people who call themselves the Essessani?

K: Yes. We are related in that we are descended from the same roots.

X: What are those roots?

K: Ancient history out of the Orion system. Many races came from there who shared common roots.

X: Do you interact with the Orion system? To what extent?

K: We are aware of civilization that is still there.

X: Do you interact with them at all or are you just aware of them?

K: Through mutual awareness we affect one another.

X: How do you perceive us?

K: I am aware of your energy.

X: Are you familiar with an entity who was called Jane Roberts?

K: Yes. This individual is involved with re-assimilating itself with itself.

X: What modes of transportation do you use?

K: We have the ability to manipulate our environment. There are no terms. We use light.

X: Are there many others in your group that are participating with you in this communication with us?

K: There are 19 others with me.

X: Is there a purpose for your communication with us?

K: We seek to expand our awareness. On your side, evolution is

bringing you to this level. We seek to establish a truer connection. By helping you, we help ourselves. Your reality affects ours as ours affects yours.

- X: Are there things that our society does that has an impact on your society?
- K: Your development toward Oneness affects us. The purer your development is, the purer the connection will be.
- X: Is there anything that your society would like to tell us about at this moment?
- K: Your kind...you struggle among yourselves...there is discord...you are of one race yet you do not live as one race...you do not allow each other as you should.
- X: What is my purpose on this planet at this time?
- K: You know what you should be doing. Only you can know what you should be doing. Only you can tell yourself.
- X: Would you also have the knowledge of what I should be doing?
- K: I have limited awareness of your whole Self, however I would not make such a statement to you at this level in order that your choice remains unquestionably yours. Your guide is your Self. You must listen to your Self.
- X: Another entity has answered a similar question saying that we should "do what excites us" with integrity. How do you feel about this?
- K: That is correct. In order for the best progress to be made, you must be happy.
- X: Is it possible to speak your language?
- K: We do not use this form of communication. We do not use language or manipulate the physical body in this manner.
- X: So you cannot say...
- K: Our communication is that we are aware of one another.
- X: Do you have a religion?
- K: Not in your terms.
- X: Define your terms. Do you believe in the existence of a supreme being?
- K: We are part of the supreme being. We are part of the whole of All That Is.
- X: What of the entity humans call Jesus Christ?

K: He is a teacher. I am aware of him.

X: There are some here who state that he is the savior of the planet .

K: By the planets terms...he is the savior of those who can be saved by their own determination.

X: Could you describe yourselves?

K: We are not physical in the same manner that you are. To ourselves, we appear as real as you do to yourselves. We are in a state that is less dense than yours and operating at a higher frequency.

X: Are you aware of the doll universe?

K: Not directly.

X: How would you be aware of it?

K: By asking for information about it through the collective awareness.

X: How do you tune into the collective awareness?

K: By shifting focus.

X: Could you comment on the human concept of Adam and Eve?

K: This was done many times...yes...but groups of people larger than two....Adam and Eve...the story is part of all cultures.. ...their purpose...inherited programming.

X: It was a test?

K: It was an exploration...expansion of the race.

X: Among humans they refer to a time of the "second coming of Christ". Comment?

K: The "second coming of Christ" is the name of the state the race will reach....this will be very beneficial to reality systems that are related to yours.

X: When will this happen?

K: It is happening now. It will continue to happen.

X: Do you know about EBE-III that is up at the Nevada Test Site?

K: What do you want to know?

X: Why is he here?

- K: He chose to experience this.
- X: What is your purpose for coming to this planet?
- K: By knowing you, we will grow. We consider this desirable. By growing with you, we make your development easier.
- X: Why is the government covering everything up?
- K: Your government is a reflection of yourself. The government operates in a manner that mirrors the way society operates. It is common practice for you to keep secrets from each other for any reason, or all reasons. These are blocks that you have imposed on yourselves in order to expand beyond them.
- X: Is the idea of religion a concept that is a limitation to be transcended?
- K: Religion is a device that may be used in either way. It is a device through which many people obtain awareness. In other cases, it may be used as a block which will be transcended.
- X: Where did the entity we know as Jesus come from?
- K: He came from within the Whole. He was of the same root as his followers. They...none of them...originated on this planet.
- X: Was everything in that scenario supposed to happen that way?
- K: It was supposed to happen the way it did.
- X: Is the reason behind the drug problem that people are trying to find enlightenment?
- K: They are seeking expansion....blindly. In some cases, altered states obtained in this manner are used by the individual toward this end.
- X: When we leave this planet, will there be evil?
- K: You will lose your concept of evil...therefore there will be no evil. You will obtain an understanding of reality that allows you to let go of the concepts of good and evil.
- X: Many people here on this planet say that "when Christ returns every eye shall see him". Comment?
- K: Every eye will see him because every person will be him. He is a state....a mental state.. that has been named "the second coming of Christ"....it is an alignment with the race itself.
- X: What of the concept of Satan?
- K: The concept is a testing device used by certain groups toward their own end.

- X: It is not a real person.
- K: The force is very real.
- X: Are you familiar with the problem of missing children? Comment?
- K: They...the entities...chose to experience...briefly...at this level...in order to use the experience as balance at another level. All disappearances are the results of the child-entities decision.
- X: Within the concepts of belief systems....where people maintain religious belief systems. Things that are applicable in the belief system are only applicable to those who create the belief system. Correct?
- K: This is true on an individual basis throughout the entire system.
- X: The nature of consciousness. Comment.
- K: Consciousness is awareness. All that is contained within All That Is possesses awareness at some level to some degree, and this is maintained by the Whole.
- X: Then all things are therefore part of the universe becoming aware of itself and expanding in potential.
- K: Yes. Growth at all levels in all forms is the purpose for all that is as defined by itself.
- X: Then each individual expands in their own reality of their own creation and accesses other probabilities to the degree that they are in tune with themselves.
- K: Yes
- X: What can you tell us of probabilities and life?
- K: The self-decided agreement/arrangement/plan of your life is largely a matter of going from point A to point B, from one state of being to another. The path taken to point B is not "carved into stone" but is a fluid movement comprised of smaller systems of point-to-point movement, or goals. It is not even necessary that you reach your goals, given that they may change along the way. Because you are not alone, because you are connected to others, you may trade-off planned experiences with others and the balance is not upset because you did not follow the plan. This can occur because you may not have known all your options when you started. You may also have learned more than anticipated with one experience that voids the need for another planned experience.
- X: Can you describe a little about group awareness to us?

- K: We are a large group. We are more than a race because there are individuals in the group from many racial backgrounds. The group is comprised of many individuals who are more or less at the same level of awareness. We experience the same awareness of each other that we do of ourselves. There are individuals within the group that I have never "met" because I have never focused my conscious awareness on them.
- X: What of your interaction with us?
- K: Our function is that of teachers or guides. We are also students and seekers. You are our teachers. We are not superior to you, by your own terms. We have more conscious awareness than you do. This gives us more ability to manipulate our environment than you consciously think you have. You have chosen to experience in this time track in which you and your race are still largely blocked from this awareness. We are of you. We are your children.
- X: Why are you the focal point of your group?
- K: The manipulation of personal energy fields is my talent. This is why I am the "speaker" before others in the group who are familiar with the language format.
- X: Do insects have group consciousness?
- K: Some do, and some do not. Some forms choose to experience separation and some do not.
- X: For insects - how do they do the choosing?
- K: The entity that put it out made this decision. The same entity may put out an insect and a person. The group consciousness of the insects level exists separate, though connected, to the prime entity that put it out.
- X: Since the illusion of being separate is one that is decided on by entities to produce experience, at what appropriate point would the entity remove the block of separation?
- K: They are not generally intended to be removed, but expanded beyond.
- X: This frequency here is being compressed. It is that which will produce the awareness of multiple realities?
- K: It is a quickening in the movement of the whole.
- X: You have said that your density is .000048 of ours. When the density level is such that beings here will be able to step into other realities, what density will it be then?

K: All exist. All are available to be stepped into.

X: Would there come a point where this awareness would come upon them no matter how they prepared themselves?

K: No. This is not an absolute for every individual.

X: For most individuals?

K: Yes

X: When the quickening frequency went to a certain point, people would start seeing things they haven't seen before, correct?

K: This is happening now, and it will continue to happen.

X: How is memory and the self integrated?

K: Memory is the self.

X: How about the concept of the Akashic record? The reflective medium at certain frequency levels that preserves all happenings. Is that not a form of cosmic memory? Does that not also contain the memories of all selves?

K: It does, for all those who can reach it.

X: So actually, all Selves are preserved forever on those levels. All memories.

K: By the Whole, all things ... all that is there. Nothing can ever be lost.

X: Individualism? Perception of ones Self as a point-consciousness?

K: This is rare, and is not beneficial to the Whole in most cases.

X: How does that relate to individualism?

K: Identity precedes Self, with value.

X: If this is lost, then what?

K: One returns to the core entity, in which creation exists.

X: What happens to the connections of the entity when it returns to the core self? Do they disappear or are there still some there?

K: They are preserved along with everything else.

- X: Inside the core?
- K: Inside the awareness.
- X: Is telepathy a wave motion?
- K: The function is sustained between two minds as they become one.
- X: On a scale of 1 to 100, where are you in awareness, assuming that 100 is oneness?
- K: We are at three.
- X: Where are we?
- K: Less than one.
- X: Would you comment on the concepts of Ego, Self and Personality?
- K: We are referring to the Whole Self and all parts of Self. Ego is a focus that is very structured and very narrow. It is produced as a tool to use at these levels. Personality is the Self as expressed at many levels, including these. Personality is the mask, the identity, of the Self at these levels. Ego is the motivation used at these levels. All will transform with expanding awareness.
- X: Transform how? Into what?
- K: Ego will fade. Personality will develop to higher states.
- X: Could you give us an example of a higher state of personality?
- K: Personality evolves by becoming truer to the Whole Self.
- X: You spoke once of the Ego being a narrow and structured focus. Would you elaborate on structures of the Ego?
- K: It functions in many ways. It is necessary at these levels. It supports the blocks that you must hold at these levels.
- X : The difference between the conscious and the subconscious is a block?
- K: Yes
- X: From the viewpoint of the conscious, the subconscious would be most appropriately viewed is what?
- K: All that you are not consciously aware of yourself.
- X: If a person is aware of their "subconscious", does that awareness preclude any other activity?

K: No. Awareness of the subconscious is given. Awareness at this level does not contain it, but goes in and out of it.

X: Would it be possible for a person to develop an Ego consciousness that would contain all the "subconscious"?

K: No.

X: If the barrier between conscious and subconscious was taken away, does that equate to awareness of All That Is?

K: No. That is awareness of Self and its connections.

X: The "subconscious"?

K: To lose the barrier would cause the consciousness to merge with the Self or subconscious and become aware of the Self and aware of the connections but not to the degree of containing All That Is, at these levels.

X: Since about 1959 in this time-stream there have been thousands of individuals that have suddenly discovered that they are in a different time and space. Pilots of aircraft report that they were flying and have, for a varying length of time, found themselves flying across a medieval battlefield...

K: It has always been this way.

X: Dimensional doorways, in effect?

K: Dimensional abilities.

X: Localized translation?

K: Various entities can travel back and forth within a limited range, at this level. There are ways for this to be done.

X: Would you care to comment on those ways?

K: This is manipulation of energy...of focus...frequency.

X: Could you describe what would happen if one would reach awareness of All That Is quickly?

K: This would be a manipulation of energy...a conversion.

X: To light?

K: It would be perceived this way by many, yes.

X: Does it become a choice for an entity to do it that way?

K: When one becomes aware that it is possible, one begins to make the choice.

X: We have a lot to learn.

K: We all have much to learn.

X: I was sitting down recently talking with an individual whom I have known a long time, and out of the corner of our eyes we saw a little sparkle of light appear and disappear in the corner of the room. What might that have been?

K: Your awareness was strongly together, when it is....it is stronger than the individuals. Your unit joint-awareness together momentarily encompassed life at other levels. This is not uncommon. At other levels, you could say that you are in tune with each other. There is a common pattern. This awareness is growing.

X: We presumed it might have been another entity that we saw.

K: In a way.

X: Would you elaborate on that?

K: All movements or actions may be referred to as entities.

X: Was the light produced by a translational process?

K: It was produced by communication.

X: Between who?

K: This is not appropriate.

X: Communication from the entity that we perceived?

K: It was not....for you.

X: The light was a communication that we perceived that was not for us?

K: Yes, it was a communication between others.

X: We perceive this to be in tune with the flow of All That Is in terms of the most intuitive way to perceive this at this time.

K: The flow is open to interpretation. By ours, this is correct.

X: Would you have any suggestions to accompany these processes?

K: You have available to you both the abilities of the group. By listening from within your self, you may open connections with experts or knowledgeable entities who are willing to assist.

X: Contact by projection of focus?

- K: Yes
- X: The process of projection of focus - would you comment?
- K: Ask...reach...listen for response...within yourself...intuitively.
- X: The response could come back in the form of an answer "within ones head"?
- K: Yes
- X: Would you comment on any relationship between light, consciousness and awareness?
- K: Light...your concept of light... is one of the most pure interpretations available to you at this level of consciousness or life.
- X: Would you comment on the interconnections between the physical brain and the focus of consciousness?
- K: The brain is like a receptacle for the sound that the mind is. It is created in such a way that it provides a lock-in for the focus. The brain exists through several levels. The physical is in several levels.
- X: How does the lock in focus take place?
- K: It is created.
- X: By the Self?
- K: Yes, it is.
- X: You related mind and sound. Would you expand on that please?
- K: There is a common quality to all forms of energy. Naming of this quality is not literally possible. It is very much like sound, though.
- X: Different question. Do 90-degree projection-rotations relate operationally to shifting dimensional focus?
- K: Not necessarily. Shifting of focus occurs naturally. It is learning to recognize it and develop control over it.
- X: How do you view LOVE in your terms?
- K: Love is the fundamental energy of All That Is. In some places, it may be related to truth. When you have surrounded yourself

with illusion, love may serve to guide you. Infinite depth and deep love are both prerequisites to expansion of awareness.

X: Sometimes there are no words.

K: This is realized.

X: From the viewpoint of the conscious, the concept of the sub-conscious would be most appropriately viewed as what?

K: The parts of your Self that you are not consciously aware of.

X: Would you comment on psychological terms we use versus what you use?

K: We do not use any terms. We use your terms as well as we can use them in order to communicate with you. Most of your terms are inadequate.

X: In your terms, could you comment on spiritual aspects to growth?

K: Yes. It is all. Spirituality is awareness. From these levels awareness must be focused. All things grow. All aspects grow.

X: Sometimes your response to questions are that a response would be inappropriate. How does growth come out of that?

K: If you are supplied with some answers, from outside yourself as you perceive it, the process is not the same as if you have taken it from within. Appropriateness is judged by the moment.

X: Are we not the same within and without?

K: We are both.

X: What seems to be the conflict with the in between?

K: Conflict is within the individual. Conflict is with the programming.

X: Programming to produce experience to produce expansion.

K: Ultimately.

X: If this process were initiated, then it would not provide for the maximum differentiation of the Whole and the production of lines of probability as desired by the Whole, correct?

K: Each incident is different. It goes not further.

X: Would it be correct to say that each Self, through programming, causes each entity to overcome certain conflicts in the attainment of a goal, and if this is short-circuited by an external, then attainment of that goal and appropriate experiences are

- not encountered by the focus, and it is a loss of experience.
- K: Yes, this is correct, and attainment will not be whole in many cases.
- X: Why are you maintaining contact with us?
- K: The project is to study the processes and functions of this connection, and to try and translate it.
- X: For what purpose?
- K: For all purposes. It serves to expand awareness, to develop and maintain control. The creative aspect is very valuable. *Our project is to experience your growth through you and exchange or offer group experience to you.* We may never develop full command of your language. If you progress to a point in the process of opening up your awareness up to other members of the group, this may occur before development of the language.. ...after such an occurrence, development in the language for us does not serve a purpose. Our foundation is not in language. It is not natural for us.
- X: Was your consciousness at our level at one time?
- K: Not exactly. We are not developed along the same lines. Our realities have crossed at different points in progression.
- X: Is it within your grasp to understand the subjective perceptions that we have when we close our eyes and go within?
- K: In some cases.
- X: I can only relate of myself. When I lie down and close my eyes, areas of my body feel numb or heavy...I am aware of them... I can then produce a deliberate internal effect (I am doing it now)....this effect amplifies the others. Then the process would be, I believe, to imagine my focus in motion. Beyond that, the process is uncertain...I can see visuals and symbols and faces and other things...I guess I am looking for...
- K: When you have reached that point of movement, you must let go of your connection. You must trust the movement. At some point, it will stop...or you will be moved to cause it to stop at some point throughout the levels for the experiences for which you have aimed. Once there, you must follow your intuition. You must allow you awareness to touch you, because it is there in that space. As you follow it, you will possibly have to keep reminding yourself to trust it. No matter what you see and feel in there, it is real and valid. What you will see are the things that you see at many levels...that you feel...
- X: The idea of letting go of the connections. I am trying to understand what this means...not that I am unwilling to do

it.

K: Letting go of the focus on the physical connection...narrowing your focus of attention so tightly on your destination...or on listening until that is all you are aware of at the knowing level. You are on the right path. The movement has reached a point where you are very close to what you want.

X: Is one of the indicators the ease at which the body goes numb?

K: Yes. The next time you go in, you can take this control. Whether or not you realize it is up to you. It is like a fine tuning... ..it is a kind of alignment and then the willingness to follow yourself. Your imagination is not as defined. Your imagination is another reality. Your imagination as you know it is where probable realities ...alternate reality lines...comes from. In this way, your conscious physical focus acts as a prime entity to these other realities, and you are fully aware of them, if not their function, and the relationship. In any focus, realities are created from within; realities during the growth of realities.

X: The concept of space filled with nodes or points relative to consciousness - would you comment?

K: You might say that these nodes or points exist in a common field, as has been expressed "sea of light", thus erasing any lines and planes. It is bubble shaped. This affords instant contact throughout any part of the Whole, whereas with the Matrix network... ..visualization...this involves concepts of "time" and "travel" and "finding direction" and such ideas that are not accurate, for the process.

X: So the actual process of visualization and the understanding and structure with which you visualize and utilize the projection of consciousness depends on the effective accessibility, in terms of immediacy, of the information?

K: Both expressions have their uses. It would not be appropriate to start with usage of the matrix of lines and planes, but with the idea of matrix of bubbles or nodes.

X: How am I in stead with my self?

K: You and X are very different. He has come to this level with an awareness beyond the norm. He has self-awareness in ways that many of you do not.

X: He who?

K: X . You referred to a remark made to X regarding standing in stead with ones self.

X: Who's asking the question when I ask that?

K: This is for self-determination.

X: Am I not X?

K: Both had asked.

X: So the physical focus was expanded more than normal?

K: It exists in a state of movement...of fluctuation...in and out.. you often bring back pieces of perception from these waves of awareness that you are throwing off your self at this level. You wish to reach further with these 'arms' and to grow as a whole awareness of self?

X: Of course

K: This is what you are doing. Pay attention to your self and your awareness.

X: When I asked you about being in stead with myself and I asked "am I not X"?, the interpretation was that my Self and my physical focus are so very close. Could you elaborate on that?

K: The realities with the choice being made one way or another are very close together. You are, in a sense, living both. All matters are matters with the Self. The other side of the choice is a reality in which the conscious physical focus awareness is much greater than it is here, or among the group, at your level that you are aware of.

X: So I have another physical focus?

K: No, but you can have, in your terms. This line of questioning is your interpretation of the decision that must be made between remaining as a physical focus as you are, and merging awareness with the group. You have awareness. You have great awareness with few blocks holding them.

X: I would like to know exactly what those blocks are.

K: One method is to closely examine all your motivations and relative circumstances through your memory. You may run across opposing beliefs, even small ones, that need to be removed. See your goal achieved in your mind, day by day. It is an appropriate exercise in creating reality.

X: Are there "right" or "wrong" decisions?

K: No. You cannot make the wrong decision. No matter what decision you make it is not wrong.

X: If other people do not accept my decisions, that is something for them to deal with.

K: Exactly. It is not their place to accept your decision.

- X: They are not aware to the point where they know that?
- K: This is by choice.
- X: Yes, nevertheless their lack of awareness of that would create and direct negativity.
- K: Your first responsibility is to yourself and your values. As your universe expands, so do others, no matter what you do. If you are good to your Self, you are good to others. As you see your Self, you see others. It is not important that they understand you, but that you understand you. If you have a full enough understanding of yourself, you will also understand them.
- X: I do understand them and why they do what they do. People often continue to ...put themselves in 'negative' positions.
- K: Regardless of the negativity another person calls to himself, you can do them no harm, You can do them no wrong. All is done by himself.
- X: In terms of cultural impact and in cultural situations, some of the things that are going on have to be 'karmic' in nature. I am trying to sort that out.
- K: The clearest way is to remember associative experience. A good example would be an experience, from your viewpoint, of knowing what you refer to as a 'past life'.
- X: I have always been motivated to help people, and teach them new discoveries....some people continuously desire assistance..
- K: Independence is a product of Oneness. Dependence is a product of that which is not Oneness.
- X: Separateness.
- K: Yes. These are major steps in many lines of development.
- X: I feel that I am on the verge of doing something.
- K: You are on the verge of affording yourself the ability to create what you want as a reality.
- X: Many wish to create realities where they will 'be happy'.
- K: All ability is magnified by happiness.
- X: It seems that things that might normally be barriers have been modified or taken away because of a strong desire to create a particular reality.
- K: This is a function of the process.

- X: There are those scoff when I reply that what I am doing is a matter of my 'soul'. They apparently don't understand.
- K: Do not expect them to understand. You need not explain yourself. You do what you must do. All do what they must do. What they say is not your problem. Your reaction to what they say is your only concern.
- X: What you are saying is that what they say is relevant only as far as I allow it to be?
- K: Yes.
- X: What of the element of synchronicity?
- K: Synchronicity is feedback and occurs constantly. Your understanding and awareness of it is the variable. You reflect all around you what you are doing.
- X: Then the degree to which one is not aware of synchronicity is the degree to which one is not aware of the process of creation of one's reality?
- K: Yes.

NOTES

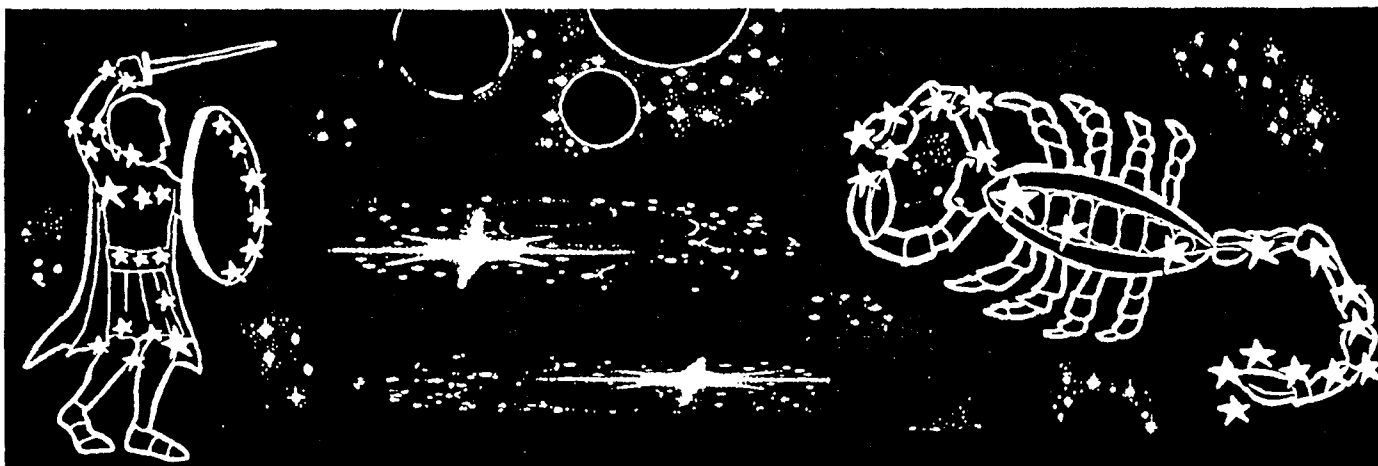

Orion the Hunter had boasted that he was mightier than all the beings in heaven and earth. For his boast, the gods sent a Scorpion to sting him...

CHANNELING, UFOs AND THE POSITIVE/NEGATIVE REALMS BEYOND THIS WORLD

by Marshall Telemachus

PART ONE

Changing Channels

What could be a more perfect topic to begin our Book Review section during the month of Halloween, than discussion of the various books on channeling? Channeling is not only a popular sport at present, but if examined closely an intriguing one. It's not at all clear, for example, what the purpose of channeling *is*; this lack of clarity actually gives it a "spookiness" that's almost independent of the fact that disembodied or otherworldly intelligences, personalities and even (shudder) "entities" are central items of the channeling phenomenon.

Consider, for example, the most common means of establishing the "inner plane" or channel connection: meditation. This is the method most recommended both by channelers *and* the given channelled source. Meditation is of course, as we should all know by now, a means of stilling the mind so that our ordinary thinking faculties are temporarily vetoed; this provisional silence of the otherwise constant "interior monologue" is the means whereby the meditator is supposed to bypass the conditioning screen of (culturally programmed) concept, in so doing becoming ideally receptive to holistic dimensions otherwise recessed into the unconscious beyond the focus of ordinary "notice". However, as the very object of channeling, out of those ostensibly more holistic zones of being comes charging...more verbiage! Out of the meditator's mouth issues another voice. In Los Angeles alone, in fact, the phenomenon is so prevalent that it seems every other face has "someone else's" voice coming out of it (although this is apparently such a commonplace of filmland that "channeling" seems more a logical extension than an abrupt break).

And a great deal of the content of such channelled information from coveted "higher sources", is taken up by odd black-key vibrations inflected into the upper registries of haunted nasality extolling the virtues of...meditation!

This of course can only mean *one* of one thing, ultimately, amounting to a largely unnoticed metaphysical tautology; you're being encouraged to meditate in order to still the chronic cover of the verbal mind, thus putting you in the properly receptive condition to pass a sonorously-rolling Voice *not* your own around the glottis in elicitation of a Speech which inevitably extols the virtue of *mediation*, as means of extracting a verbal instruction that tells you...

Now *that's* spooky! It's almost another version of the oddly reverberative "self-reference" paradox (you know, the peculiar conceptual log-jam which occurs when a categorical negative is expressed in first-person, i.e. "all statements are false, including this one". Richard Hofstadter would have a field day deciphering the Moebius code which the general program of "channeling" carries!)

To be fair, the exhortation to "meditate" that emanates from channelled sources, like t.v.'s exhortation to watch t.v., ostensibly points to a content beyond the significance of its own form-in-itself; i.e. just as television bids for your attention presumably because of the *information* it carries, so channeling claims your attention by way of the meditative mechanism apparently because of its unique power to bring a stream of extraordinary news. People consult the channeler, after all, not only or even particularly for the edification of the standard message to meditate, but largely because it's expected the source can produce a verbal description of conditions and events beyond the ordinary ken of three-dimensional faculties.

We consult the channeler because, basically, we are *concerned*, in a very ordinary conceptual way. Like every personality anxiously poised on the psychological tightwire spanning the temporalized chasm of existence, we grope in ambiguity over the Questionmark of chronic incompleteness supplied by the tenses in which we conjugate the terms of ego-identity; it would always be oh-so helpful if we could see the future in advance, be informed of the respective consequences in the alternatives confronting the present perplexing moment of decision. We would like if possible to be underwritten not only for our monetary but for our psychic commitments, insured in advance against the usual contingencies; and the channeler proffers the prospect of just this excelsior potential.

The channeler in a sense, then, *exchanges* the personal power

of verbalization born of limited perceptions for the transpersonal power of *verbally portraying* dimensions or aspects of being otherwise inaccessible. The myriad channeled voices to which we have been opened in recent years do indeed present an avalanche of prediction, of advice on principle and in particular, and a massive characterization of planes, states, levels or dimensions of reality introducing whole other *magnitudes* to the ultimate questions of purpose and consequence. Through the innumerable contributions of channeled sources we have been, in a certain sense, asked to reappraise the whole matter of *success* in terms beyond the conventional, so that the horizon upon which the grail of accomplishment rests has been as it were elevated, the sights raised to the prospect of a more comprehensive and crucial, indeed *sacred* focus.

On the "plus" side then, the phenomenon of channeling has supplied a verbal *chorus* of confirmation tending collectively to install our usual questions and concerns in a setting offset by distinct considerations of Soul. The "answers" to our most mundane queries as to future, choice and result have been furnished a whole additional *dimension* of meaning, so that the most casual skimmer of "channeled" material can't help but perceive at least implicitly the bearing which every conventional ego-choice has upon the larger destiny of soul-growth. Never mind for the time being that such emphatic intimations result from a *cutting in*, an abrupt verbal funneling of the basic meditative stream which was ostensibly moving toward the unique value of personal (unmediated) cognition and direct perception of those very, spiritual and high-psychic modes now presented by descriptive approximation. Never mind that the whole phenomenon seems in a certain light to express the *impatience* of higher-dimensional intelligence long waiting for the sluggish personal development characteristic of this "material plane" and so simply intruding with the necessary packets of information at the minimal achievement of some meditative quietude.

To be fair, some "channeling" circumstances seem to promote the personal progress of the channeler in gaining direct access to the planes, states, phenomena and degrees of mind-body integration otherwise only described or verbally characterized by ventriloquist voice-transmission (cf. the *Seth* material, and the late *Jane Roberts'* occasional description of her personal development in "inner plane" understanding). But for the most part, the expressed *Ryerson*-attitude prevails, which amounts to a curious dissociation between the person of the channeler and the content of the communication resulting practically in an overall *substitution* of the description for the thing described.

More immediately, on the *minus* side of the phenomenon we end up (in this avalanche of description from various sources) with a collision rather than a smooth confluence of materials. At the "higher" levels of consciousness not limited to the spacetime framework of the blindered channeler, there still seems to be contention or discrepancy in the respective characterizations of Reality; there still seems to be division regarding that which is perceived or known *even* in these greater and more allegedly comprehensive Domains of Knowing. Any who've scanned more than one of these sources in print, or compared notes with "live" sessions attended, are bound to notice (if minimally conscious) that, beneath the *general* agreement as to the existence of higher states and planes, of different orders of knowledge and action from those assumed in the context of strictly physical expression there is a *welter* of large and small divergences ranging from minor variations to an embarrassment of glaring contradictions.

This is explained in one such source, *Cosmic Revelation* "channeled" by *Virginia Essene* and *Ann Valentin*, as the inevitable condition of confusion resulting from the urgent/unprecedented need of the "higher dimensions" to disseminate changing patterns of information belonging to "revamped educational programs", brought about by this critical epoch of transition through which we're hesitantly passing. Such confusion according to this source results from the

requirement of transmission along the *spiritual hierarchy* of inner plane beings through which such "information", formulated at the highest levels, must pass. Consistent with what may be gathered from other source-channels, the various levels along which the orders of intelligence transmit the flow of data "downward" formulate the patterns of information according to the understanding of their particular plane. Tintured already by that qualification, the information may receive its most noticeable distortion at the level of the channeler where, according to the variable of the given "linkage" there may be greater or lesser reliance on the personal memory-record, conceptual matrix or vocabulary of the channeling agent. The resultant verbal product is, in any case, several dimensional steps removed from the originating Intention. Add to this the recognition that all such knowledge emanates in its highest form from levels of creative intelligence that are basically non-verbal and that conduct all processes of knowing in abstract spiritual terms not directly translatable into concepts congenial to a physically-focused framework, and we seem to have on the surface a convenient explanation as to why *Seth* and *Hilarion* don't agree, why *Ramtha* and the "Christ" material of *The New Teachings* apparently quarrel on the shelves.

However, does this layered meshwork of spiritual cheesecloth through which the channeled curds are continuously strained really account for some of the comparative anomalies that, independently, speak with such assured and *specific* Voice?

Let's take a page from the *Essene-Valentin* material of *Cosmic Revelation*; let's listen to the Voices of "the Rays" and, like good researchers honoring the strictly scientific method, take them seriously on their own terms the duration of the experiment in order not to bias the results of testing their hypothesis. According to "the Rays", there must be a massive effort on the part of incarnate teachers (i.e. those sharing the *embodied* condition and thus the communicative premises of the physical dimension) of the levels "4, 5, 6 and 7" to collate the welter of incoming data, organize it into a coherent corpus of principles, premises and usable esoteric knowledge. "The Rays", in other words, invoke the cooperation of initiated teachers functioning in and through the physical dimension, exhorting any or all such teachers to act as the topper of a cosmic loom coordinately combing separate strands of starry Material through the distaff.

When however such an Initiated polarity *does* respond in the proper scientific manner to the call of this experimental hypothesis, something unexpected happens. After all, the Rays' proposition being *in fact* an *hypothesis*, a premise to be proved in practice, we are *not* assured before the fact that one element of the resultant equation will go evenly into another without fuss or irrational byproduct. And indeed, it seems that, by taking *Virginia* and *Ann's* "Rays" up on their own proposal, it is They along with various others that tend to suffer in the ensuing Comparison.

If we're going to tackle a task which even a cursory survey will show is proportional to the Purifying of the Augean Stables, we'd be greatly aided with a fit standard of measurement. Given the premise, it would be bad form to pull out a yardstick that derived from other than the material in question, since that would be *begging* the question and would bring up the additional problem of an extraneous source-verification. If we're going to extract some sufficient standard from the gathered data itself, it should be identifiable at the highest level of initiated understanding; its explanation should pair well with the patterns cast by the most intensely integral and holistic light available to initiated consciousness, and if possible should indeed serve to illumine certain details of such patterns beyond that which is already known at the level of Awakened *physical* focus, by virtue of its origin in the field of some comparatively unfettered Perspective.

Probable Seth

There is always of course the *Seth* material, which is the granddaddy of such channeled information and which is often over-

looked in the turbulent consumer-drive for the new, the novel and the “up-to-date”. One would hope that metaphysical principles and deep philosophical points couldn’t be so easily “scooped”; the *Essene* material seems to suggest that we’re subject to an information *turn-over*, as if spiritual truths and “eternal verities” showed the newshour brand of transience on their bovine flanks as they lumbered past our post toward the stockyards of instant antiquation. This is indeed all-too-true of much channeled material which frankly seems designed by an otherworldly Madison Avenue only interested in fashioning the latest catchphrase. What made the *Seth* material so noticeable, and what allows it to stand up well today, has much to do with the channeler **Jane Roberts** herself who—along with the channeled text—narrated a continuous chronicle of her own internal struggle with the whole *phenomenon* of channeling, as well as the content of the material. The uniform quality, consistency and integrity of the *Seth* teachings which spanned many years (compared to various one-shot sources today) was largely due to the strangeness and unfamiliarity of such a mode visited upon *any* consciousness at that “early” time meeting head on a rational and intelligent—if critical and initially quite skeptical—personality.

As **Roberts** herself states from the perspective of experience, it was indeed the initial dubiety, the deep reservations accompanying her reluctant participation in so extreme a phenomenon that kept the keel even, and helped therefore to keep the communication steadily aligned along the potential shoals of egoism on the one hand and reductive rationalization on the other. There is, as anyone should be able to tell, a universe of difference between these carefully monitored, combed and curried sessions and the modern immoderate opus cavalierly compiled across the familiarizing interval of time since the Summons of *Seth* wherein the chief feature of the inevitable book seems to be the channeler Herself, lavishly displayed on the pages of the photo insert coyly captioned from “childhood” to the “mature adult present” (in which, having donned a pyramidal duncecap in a moment of pure caprice the subject became so suddenly Serendipitous Host to some materializing entity, quite helpfully clarifying things at the outset by announcing Its Enlightenment).

In considering the *Seth* material as a whole, we can recommend it on the great virtue alone—taken for granted by now, but quite unique for its initiating time—that it introduced the important key of *probability* to the field of psychological reality, thereby freeing the idea from its exclusivity as an abstruse phenomenon of physics (occurring—to any significant degree—only at the Heisenberg-indeterminacy level, fit for the “position and velocity of electrons” but unsuited to strip the material mind from its fixation upon rigid causal conditioning and deterministic hypotheses of action). The *Seth* discussion of *multidimensionality* and the branching probable paths of conscious navigation through the wake-and-dreamstate served to shift the fulcrum of power to the bristling psychic present, thereby helping at once to loosen the mental clamps of a dominant behavioristic psychology and to perform a long-overdue correction to the religio-spiritual emphasis on *karma* or the irresistible pressure of past actions, mnemonic conditioning etc.

In this respect then the *Seth* material served its purpose admirably; and that purpose was to help consciousness take the *next*

great step, the necessary step into a whole new Stage of spiritual progress and development.

But in order to have a perspective upon the very *framework* of implicit stages in which all such development takes place, it no longer suffices to remain with the *Seth* material; and although certain other “channel” sources have subsequently touched upon the subject, one source alone stands out as a comprehensive overview; agreeing with **Andrija Puharich’s** endorsement, we find proper standard and sufficient yardstick in the material known as *The Law Of One*, otherwise known as the *Ra* Channeling.

And why should such a designated source show particular superiority over any other? What makes it stand out? Again, we’d have to account for its quality by noting the *way* in which the source was channeled (rather than simply consulting the proclaimed level from which any such source ostensibly emanates). Whereas **Jane Roberts**, for instance, functioned as a one-woman hawk of vigilance in a way which most modern band-wagon channelers manifestly don’t, the *Ra* material was conscientiously culled from the cooperative, carefully coordinated interaction of a minimum of three participating personalities, i.e., **Don Elkins, Carla Rueckert, and James Allen McCarty**. According to their own listed precautions and further *communicated* suggestions, the group used various ritual and formal

meditative devices to ensure the purity of the process and also...to ensure protection. For as they were to find out, contrary to much saccharine communication from the alleged “beyond” all is *not* necessarily well in the real Realm of the Higher Dimensions.

The *Ra* material, of all channeled sources (and as a fine-tuned, “narrow-band” communication) presents a cosmic overview both in terms of the multidimensional stages or “densities” of conscious progress in the Soul’s awakening to the spiritual holism of the Creator, and the developmental progression of galaxies and planets as evolving vehicles of those densities. Such an overview is enabled by virtue of *Ra’s* status as a “social-memory-complex” of

the “6th Density”, a locus of functioning sufficiently congruent in alignment and integration with the Spiritual Whole characterized as “7th Density”, to account for its unique power.

Other Realities OR the Octave of Ra

(The following summary of the Ra Teaching parallels the discourse of that Intelligence from the initiated viewpoint, and therefore supplements where necessary according to a direct knowledge or insight which finds its deepest chords of congruence with that Material, as far as any channeled source of information is concerned).

According to *Ra*, the units of consciousness that become the developing Soul-vehicle or mind/body/spirit complex evolve through octaves of Creative Expression known as densities. There are seven densities and an infinite subdivision of seven-fold levels within each density, that compose a spiritual Octave. The planets and star systems exist, multidimensionally, within and as the vehicles of these densities, so that for example the sun is not just the physical source of nuclear fusion we know as a materially-focused subject; the sun exists in various states and forms *through* the densities and simply has the radiant appearance *we* know in our characteristic 3rd density field, just as Earth exists at least in potential through all the densities.

The movement of the lenticular systems as a multidimensional



whole, accounts for the cyclical and coordinate passage of the various suns and stars through "local regions" of transformation in which a basic revision of the nuclear material occurs and the perceptual patterns are realigned so as to install the given "body" at a progressed density or level.

Our solar system, and therefore Earth, is passing through such a transitional space now, so that our 3rd density planet is in the process of transmuting to a 4th density body.

The friction that characterizes the maladaptation of 3rd density, materially-focused consciousness as a whole in relation to the more spiritualized or subtle density of the oncoming 4th, accounts for the manifest difficulty of the transition with its attendant natural and manmade calamities. Obviously, such transitions don't *have* to be so difficult (the Ra entity, for example, describes its 3rd-to-4th density transition on the planet Venus millennia ago, as very smooth and harmonious); but the 3rd density consciousness we collectively embody does represent in the scheme of things a certain critical level. In order to understand the threshold character of that level, and therefore to appreciate the requirements we actually confront at this point, it's helpful to explain here the system of densities as a whole according to the Ra account.

"You Are My Density" (George McFly to Lorraine in *Back to the Future*)

First of all it's important to explain just what is meant by "density", since its use in this material is extremely helpful to our understanding *once we clearly distinguish it* from the common usage that allies it with terms of inertia and opacity synonymous with strictly physical existence. Although nowhere in the material itself is the term "density" sufficiently explained so as to make that distinction, initiated intelligence would have you understand "density" in the sense of *richness*; the density of a manifesting plane or space is not a calculation of its inertia in this context, but to the contrary of its subtlety. It is easier to understand density as the degree of coherent activity, the characteristic "accommodation" of a given volume with respect to the perceiving system. The mathematical discipline of *sphere-packing* is helpful as a concept in grasping this definition. (How many oranges can be packed in a crate?) Sphere-packing employs the "greedy algorithm" in calculating a pure economy of space and is therefore a very practical help in communications, though it may theoretically work with an infinite number of dimensions. "Density" is analogous then to a multidimensional sphere-packing; the greater the density the more information a given volume codes, the greater the energy-value and richer the potential as which the space is configured. Like the discipline of sphere-packing, the idea of *density* implies a "geometry of information".

For example, we well know the "law" of 3rd density, our present collective plane of focus: "No two objects can occupy the same space at the same time". It should be obvious that this is a function of *perception*, for the operative coordinates of perception determine the outline of what's to stand as an object. According to 3rd density focal alignments, the descriptive units of "objecthood" are mutually exclusive and define one another by contrastive polarization. Perception of the essential *coinherence* of all mutually defining, polarized terms as an inextricable unity of complementary values, is a function of a higher-density cognition (or depends on the use of faculties *belonging* to the presently recessed planes and energy-systems of the higher densities). Thus when, in the course of spiritual discipline or occult practice performed through this plane we presently perceive a luminous wholeness and basic *simultaneity* that shines through all apparently separate objects (even though in the field of tangible perception such objects may persist in the perspectival "relief" that makes them appear distinct) we are actually experiencing a mind-body alignment or momentary, harmonious coordination with energies and instruments belonging to other den-

sities drawn into our frame of reference

In this way we can understand the basic condition that comprises a given density. When the Ra material talks about "1st density" it's talking about the developmental condition of a planetary sphere as it moves through space the highest functional unit of which is capable (in itself) only of supporting the degree of "consciousness" and "light" known as mineral. It is, in other words, not yet of a sufficiently rich "intensity" or degree of complex energy-organization through any given section of its system to support the minimum, coaxial cross-correlation of mirroring values indicative of the threshold of *self-conscious* being.

When the Ra material talks about "2nd density", it's talking about a planetary condition the highest functional unit of which is only able in itself to support the degree of consciousness and light (still therefore a "sub-conscious" degree) known as vegetable, and later animal. Such a density is not in itself of sufficiently rich and subtle composition through any given section of its system to suggest the viability of a self-reflectively conscious axis.

Only the 3rd density of planetary development is sufficiently rich and symmetrically potentiated through a characteristic cross-section to imply the patterning of perceptual and cognitive processes belonging to an axis of truly *self-reflective* consciousness.

The 3rd density degree of self-reflective consciousness is the "moment" when the Soul awakens to itself, first through the patterned mediation of symbolic or representative values. It is therefore the "moment" when the unit of consciousness becomes aware of itself by a process of *modeled approximations* (i.e., the ego-image, the constructed or synthetic "self" of the memory-patterns). Its self-representation emphasizes *mind* as the mediator of consciousness through perceptions and cognitions; its chief vehicle is the verbalization or abstract-imagistic description of the interior monologue.



Its immediate *potential*, however, is the pure awareness of consciousness in-itself, without descriptive characterization or provisional modeling.

This is why the 3rd density of consciousness (i.e. the *self-reflective* capacity of planetary Being) is a critical threshold stage. Its potential clarity with respect to its own existence aligns it in congruence with the complete, multidimensional axis of consciousness (this is symbolized in the vertical, bipedal posture of the cerebrosplinal "trunk"); for the being of consciousness is no longer *structurally* hidden from itself. It is at this stage only masked by self-assumed patterns of symbolic modeling. Thus the Being of consciousness is *functionally* masked from itself by relative anisometric alignments along the minimally harmonized, globally potentiated mind-body axis; but that axis is itself the Line through which the Creative Intelligence of spiritual Consciousness generates and organizes the multidimensional patterns of all the worlds.

Raised up in essential congruence with that Line, the potential of 3rd stage self-reflective consciousness has theoretical *access* to all the powers, properties, vehicles and instrumentalities of the densities (lower or higher with respect to its chronic, 3rd-stage focal lockin) according to the functional degree with which it can further integrate and harmonize its processing currents efficiently modeling the *perceptual* vocabulary through habit-patterns of identity.

Thus the 3rd density of conscious development represents a very decisive stage in the progress of Soul-realization. In a certain sense the destiny of such development has been shifted into the "hands" of self-reflective ego-consciousness. What *conditions* such consciousness at this stage are the inbuilt patterns of ritual-sur-

vivalism, reproduction and power-acquisition developed on the basis of lower-density experience recapitulated through the basal-brain lobes of the R-complex and the correlative abdominal centers of the autonomic currents in the extended, mind-body form; what *beckons* such consciousness of the 3rd stage level is the intimation of the higher densities of intelligence and life, received at varying degrees of strength and awareness through the unity of the cerebrospinal axis or multidimensional, conscious Trunk itself.

Most immediately, the 4th density (characterized by Ra as the density in which are learned the lessons of Love and Understanding) calls consciousness, vaguely or urgently according to the quality of attentiveness, to the experience of its *psychic* dimension as the first overtly "spiritual" zone disclosed to awakening intelligence. From the clarified value of this density revealing certain secrets of Consciousness to itself, it is learned just *why* the 3rd level of self-reflection was patterned in such a way as to initially mask the character of Reality as a spiritual magnitude, substituting a representative alphabet of symbolically modeled "name and form".

From the parting of the Veil draped across the perceptual threshold of 4th density, a distilled sense may be obtained of how previous Logocentric experience with worlds of soul-development found such process slow or positively stagnant, due to the absence of an adequate *catalyst* which might serve to move mind toward active search for a deeper Being ultimately commensurate with consciousness-in-itself. Thus according to Ra the device for the succeeding Logocentric pattern was formulated, i.e. that of *screening* the value of spiritual inheritance (or Void-nature) from the perceptual potential of 3rd density where consciousness first takes estimable stock of itself.

Cubing the Circle

Since dimensions are handily defined by "mutual perpendicularity", such a screening process can easily be conceptualized with the use of Rubik's Cube. If the perfect harmony, integration and mutual alignment of the dimensions belonging to the Octave of Densities may be visualized as the Cube rotated at its optimum coherence of color-matched sides, then the screening process (whereby coaxial currents of information-patterning are "skewed" so as to distort the view of existence away from direct cognition of maximally-symmetrized, self-cancelling Void-reality) may be similarly understood by seeing what happens when we give the Cube an arbitrary twist.

By this analogy it may also be understood how there arises a variable gradation of patterns and multidimensional, coordinate-alignments by degrees masking or disclosing the noumenal condition of Void-nature through the given perceptual field; for just as, in reassembling the optimal alignment of the sides and colored units of the Cube we may pass through stages of experimental combination each turn of which has multiple repercussion across mutually-perpendicular axes, so too in employing our endowment of overt and hidden faculties for purposes of plumbing the paradoxes perplexing our normal reality-constructs we may trigger electrochemical codes and dormant keys in the magazines of our complex circuits which magically power a differential repertoire of focal-compounds and variable alignments.

Rather than returning immediately to the perfect, global coherence and symmetric cross-correlation of systems indicative of the pattern at perfect "rest" in its inspiring Ideal order, we may pass through any number of mediate combinations and organizational variants which, like the tumblers of the Cube occasionally mating one or two whole sides may function through partial match-ups, turns of more "direct" integration and alignment which nonetheless from the Aerial View leave certain unseen phases in relative disorder and "incompletion".

Thus we have, at the 3rd density level and even beyond, the interesting circumstance that the spiritual common denominator of Void-value may be known through any number of disciplines or

"slants" producing some reorganization of the mind-body circuits within the framework of the Whole. Yet all such disclosures are, in themselves, metastable. They require constant work in adjusting, shifting and realigning the operative coordinates in experimental feedback generating an ongoing "adventure" in God-seeking since the given illumination was produced in the first place by a fortuitous ratio of interaction among certain emphasized centers and magnetic circuits (dialing one of the "permissible" combinations that serves to draw perception across the minimum requisite threshold of select, self-cancelling symmetries).

Thus we have the traditional testimony of mystic and sage, the magus, yogi and zen adept each describing a variation on Void-nature sufficiently consistent and corroborative one with the other as to give rise to the idea of universalism in the match-ups of Comparative Religion; and each at the same time characterizing the conditions, the indispensable fields or internal requirements of that Void-nature

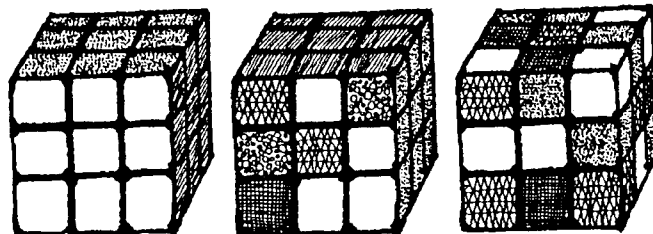

in terms sufficiently disparate and *unique to the given combination of centers* as to generate the classic contentions and "dharma-combats" indicative of the traditions.

We may understand the business of the densities, then, by analogy with old Rubik's damnable Cube. We may imagine that our minimal, threshold level of self-consciousness in 3rd density is similar to being installed at the globally symmetric center of the cube (thus our potential for *self-reflection*, since we're functionally established as a locus of cross-correlation and convergence through a system of Looking-glass planes inset for infinite, imagistic regress like a complex of dressingroom mirrors); at the same time, the units of each side of the cube are still at their maximum state of disorder, so that everything is *functionally* perceived through distorted patterns of mazelike indirection.

This condition gives rise to some interesting potential, in the formally screened or "masked" patterns of 3rd-density reality. Keeping in mind that this calculated screening of the direct recognition of Void-reality from 3rd density consciousness is for purposes of "producing catalyst", we see that the practical result of such disguise is the generation of a necessity for *choice*. Since the absolute coherence, unity and ecstatic identity of everything with everything else on the ground of Void-reality is *not* directly perceived and is therefore not a functional "given", the self-reflective ego consciousness of 3rd density is confronted with the requirement of assessing the *implication* of all interaction with other beings, and of choosing an orientation on the *basis* of that *assessment*. Given the full complement of rational and intuitive faculties with which 3rd-density consciousness is equipped, and which may on the basis of *identification* function either in congruence with or in antagonism toward the underlying principle of unity, that consciousness is empowered to determine just what the informing character of its reality is.

Thus, it can either ratify by experimental reflection and analysis of consequence (of relative "cause and effect") the essential unity and empathetic identity of all beings one with the other; or it may reject the implication involved in the *empathetic* extension of selfhood to other-beings, preferring to compound the harmony, self-congruence and integral consistency associated with the principle of selfhood in a purely personal portfolio of ego-investment, drawing on the option made available through screening of direct Unity-cognition by encoiling the love-nature around a fictitious core of separate I-hood.

Thus 3rd-stage consciousness is always reflecting a potential polarization between exclusive self-orientation, and an apprehension of selfhood which follows the intuitive lines of the undivided void-ground in extending that love value to all apparent "others" (i.e., all those comprising the "objective" dimension of the subjective self-sense).

Polarized Harvest, the PII Factor

This is very significant, for, according to the Ra material, the work of crystallizing the extremes of this potential polarization is the real and underlying business of *3rd density existence*. We have lived our myriad rounds of incarnation through this density ("preserved" between physical lives as a memory-record of identification patterns coded in subtle-dimensional media through the Soul matrix like a holographic "working-beam" locked in comparative integration with the "virgin beam"), strictly in order to produce this polarization, to one side of the "self" equation or the other, out of response to the "masking" catalyst of opaque physical existence.

The inference is, of course, that the "balancing" mechanisms of karma or impressional continuity do not merely serve the simplistic rectification-process characterized by our traditional good-active spiritual teachings; those balancing mechanisms, depending on the aggregate tendency of the ego-soul over the greater span of its incarnative history, may serve either to harmonize the self-complex in conciliatory service toward "others", or they may function to consolidate an insular harmony about the basically fictive complex of ego in aggrandizing service toward itself.

This polarization of "service-toward-self", "service-toward-others", is then the *object* of 3rd density incarnation; in light of the Ra Teaching, such polarization-alignment determines the "harvestability" of the soul-entity at the close of each Master cycle (a period which we are living *right now*, and which will end—in close correspondence to Mayan prophecies etc.—around the year 2011). "Harvestability" is the manifest ripeness of the soul-entity to proceed, by virtue of the minimal threshold intensity of its polarization-alignment in *either* negative or positive direction, to the more subtle lessons of the higher densities beginning with 4th, which offer the benefit of being basically unscreened and thus openly congruent with qualities of bliss-love, integration and wholeness (whether "wholeness" conceived in terms of strictly private or *transpersonal* continuity).

The implications of this teaching may come as a shock to many. For it clearly indicates that the separative and self-seeking "delusion" of negative egoity (developmentally possible at the level of 3rd-stage screening), is capable *itself* of achieving a dedicated integration and overall alignment in one-pointed devotion to its own, absorptive aggrandizement which through *its* polarity is as spiritually potentiated and ripe for "advance" as its positive counterpart! Uh oh. Does this mean that we are to bump into the negative ego-complex even in *densities above the 3rd*? Does this mean that, just at the point we thought we'd shed the shadow of that despoiling antagonist, it looms large once again only amplified by the additional potency belonging inherently to the unscreened higher dimensions?

Yes it does. Indeed, such a negative ego-complex must be *high* in the achievement of such integral intensity and mind-body alignment of the organizational currents about the illusory nucleus of the separate "self", in order to merit such harvestability (just as the positively polarized being must exhibit a comparable intensity of alignment); at that requisite degree of harvestable negative polarization, the being must have achieved a certain value of *purity of its type*. Such purity in the traditions goes by the name of "demonic".

Negative Greeting (Hell-O Harvest)

Just as positively-polarized beings are advanced after Harvest to the unitive level of *social-memory-complex* compatible with the unity of that greater density, so the negatively-polarized beings are advanced after Harvest, "waking up" to the potential hierarchy of

positions (sorted and settled through preliminary battle) comprising a parallel Negative "social-memory-complex". Whereas in the polarizing field of 3rd density the relatively "positive" and relatively "negative" personality-complexes were admixed upon the same general orb so as to intensify the confrontational power of catalyst, in the 4th and higher densities the clearly polarized positive and negative beings are distinctly separated into different psychic spheres of patterning. These distinct planetary loci then pertain to values of the higher densities differently polarized, either positively or negatively. In this way, catalyst for further intensification and resolving harmonization *continues* to exist even in the higher, "clear" densities where the unitive value of Void-nature is a direct and immanently *functional* reality.

The relative "delusion" of self-recoiled egoity is able to persist and operate even through such a unitive void-ground, and strictly on *its* terms, since the initial formulation of its delusive premise was enabled in the more opaque incarnational atmosphere of 3rd density where it was *not* bathed in a choiceless Unity and harmonization of polarities from the beginning; now that, by virtue of its harvestability in orientation about its own shadowy axis it is able to function through the *overt void-planes of being*, it may be characterized as a true *spiritual evil* for it *chooses* its orientation quite freely without the functional restraints and cognitive masks that formerly had forced its association with a pattern-lockin relative to the fragmentary left-brain fixation of dualistic material focus. As the Ra material states it, a harvestable negative Being demonstrates a *conscious preference* for Negativity, regardless the incarnational conditioning that served as point-of-departure for that polarization.

Such a distinctively *spiritual* (because chosen, conscious) *evil* functioning from higher, psychic and subtle planes, gives objective justification to the traditional insistence of the religions both East and West as to the reality of *conscious negativity, intelligent malevolence* and thus...real demonism.

The Ra material explains that this higher-dimensional "clinging" to separative egoity creates a military-like hierarchy of negative beings who, as previously harvestable entities, had shown a *clear preference* for manipulation and enslavement of "other-selves", for the control involved in the inducing of fear and pain etc. even when able—at a certain point of consolidating pressure—to *see* the resultant magnitude of Void-Light made indifferently available to any such degree in the threshold integration of intent. Due to their *negative* polarization through the higher densities they exist along a current which nourishes itself on the psychic energy-exudate of emotional distress, sadness and terror etc.

Their purpose is "the same" as that of the positive beings; existing a reality informed directly by the unitive ground of ultimate spiritual holism, they seek a degree of intensification and alignment commensurate with the attractive value of that ground. The difference is that the negative beings seek to "stuff" that infinite magnitude into the dimensions of the illusory ego-nucleus, the retractile self-center of furtive, unapproachable "subjectivity". The *means* of their further polarization toward progressively higher densities is the diabolical pattern of "conscripting" an expanding number of uncommitted or as-yet-insufficiently-polarized souls (necessarily recruited from the schoolyards of 3rd density worlds) to the ranks of negative polarity, thus earning merit by stocking and replenishing the Negative waters with a proliferating spawn of self-serving subjects lured into "obeying" the propaganda of the Negative hypothesis.

Because they constitute a *spiritual* Negativity their tactic is an interpretation of the presiding divine law regarding the conservation of *free will* in all instances, so that success is measured by the cleverness with which *obedience* to the principle of self-serving is elicited as a conscious option. In this way the *negative beings* of the higher dimensions promote the *attractiveness* of enslavement of others. Enslavement per se is a *coercion* of free will so that, by itself, it does not aid in further polarization and thus advance of the negative being;

the negative being is interested in conquest and dominion through persuading the formation of a "power elite", the members of which will have *chosen* the path of self-service. Those who *are* enslaved, in turn, are subjected to the well-known stress of self-protective psychological identification with one's tormentors (cf. studies of the victims in Nazi concentration camps) so that they will ideally seek a similar power as the "winning hand", thus arrogating the "virtues" of self-serving to themselves.

Fourth density discloses Void-nature in the form of a subtle, perspectival anisometry so that the "void" of reality takes practical shape as a reticulation of psychic tunnels, hollows of conducting passage formulating a cosmic webwork or energy-net of interlaced holes and cognitive tubes; here the "transdimensional ducts of hyperspace" comprise a living psychic reality, drawing a starry network of spatial corridors for the continued, collective Seeking of the Creator.

The positively polarized social-memory-complex of 4th density roams the known galaxies in "spacecraft" that are actually biomechanical extensions of the members' electric current-envelopes or auric fields, energizing a living psychic technology for purposes of patrolling the available dimensions—regulating the allowable comings and goings of positive and negative influence with respect to developing systems and in general seeking modes of service which will enable expansion in pure Understanding so as to polarize more efficiently toward congruence with the higher densities, and ultimately with the Creator.

The negatively polarized social-memory-complex, similarly roams the galactic corridors in its biomechanical "spacecraft"; its members scout with predatory eye for likely worlds of "light" (i.e., self-reflective consciousness) upon which to poach, seeking always to create a power elite under the negative entities' control which will in turn prosecute the pattern of controlling others. Thus the "highest" in the Negative hierarchy stands at the summit of a cosmic and planetary chain of control, a chain always looking to bind increasing numbers in the promotional links of negative Empire ("Empire" is Ra's terminology, a *Star Wars* analogy Elkins did not fail to note).

In the case of both positive and negative beings of 4th density polarization, the negotiable currency of their transactions is a biopsychic energy; the mode of both is accumulation, in the sense of storing and putting such biopsychic energy-capital to work in power-

The world of 4th density is an astral webbing through which etheric and physical components organize as the sensate-olfactory extremity of a total, incarnative Vehicle or body-complex; it is therefore similar to what's experienced through the "inner planes" when 3rd-density consciousness dissociates in its *astral body*. It is a medium surcharged with the symbolizing "numen" of what we usually associate with the dream state. Yet to the quickened spark of self-reflective awareness struck in that continuum it is a world of perceptual properties as consistent in the laws of their behaviors as the perceptions of the material dimension are consistent with respect to their own. Whereas however the "astral" is commonly experienced by 3rd-density consciousness through nocturnal dissociation of the nested inner vehicles as a disembodied state, 4th density represents the coaxial extension of a focalized and locked-in, incarnative consciousness sweeping the span of available states from the psycho-symbolic to the electron circuit of condensed tactile value we identify as "physical".

Thus 4th density beings are astral-psychic entities in their optimum degree of awareness, with a physical-complex (electronic) component organized and extended through the patterning alignments of astro-etheric cohesion. The biopsychic energy which constitutes the "negotiable currency" of 4th density beings, is their natural nutriment. It is not just the "fleshy leaf" upon which they sup, but the specific value or psychic charge of its enveloping *astro-etheric* atmosphere. Positive 4th density beings achieve greater polarization

through aiding the maintenance and peaceful, harmonious furtherance of energy-rich spheres such as that of earth where biopsychic entity of a less advanced stage nonetheless generates tremendous "loosh" (in the terminology of **Robert Monroe**) through the surcharged atmospheres of a self-reflective—and therefore abundantly productive—degree of consciousness and light. The peaceful promotion of a unitive continuity and energy-intensive "advance" of such globes, planes and worlds as the physical we know, serves 4th density positive polarization creating as it does a general spread of coherent *nodes* in the universal net functionally coextensive with social/memory/complex "bodies".

The "saucers" of 4th density, being biomechanical vehicles, serve the group entity in energy-intensification and enrichment by virtue of their means of propulsion through the "nutritive menstruum" of astro-etheric atmospheres, in operative continuity with group-biological configuration. The "saucer" is not then an independent "tin can" hardware vehicle of the type we know, but is rather more like a pattern-crystallization of the group psyche or auric field of its "pilots". Similarly, the negative beings of 4th density are accelerated in their particular polarization through the sowing of stress and disintegration in energy-rich fields, thereby breaking down and converting the nutritive substance of biopsychic life indicative of a given zone into material suited to their psychically styled "digestive" needs.

Taking the Fifth

The current-intensification and coordinate alignment of *5th density* is accelerated to a power sufficiently comprehensive as to change the character of "spiritual seeking" for both positive and negative beings, and establish it on a different basis. Whereas 4th density was involved in the intensive effort of energy-acquisition and consequent "boost" (as if realization were an asymptote curving toward the focus of a Horizon subtly displaced by the margin of Planck's constant from perfect resolution), 5th density comprises a kind of *discontinuity* that suggests a true crossing of the Abyss.

In 5th density the basis of spiritual realization changes, with an abrupt jump as if recognizing the psychic energy-lanes of 4th density "travel" as a simple cul-de-sac. Here one should do a double-take, and consult the **Castaneda** book *The Eagle's Gift*; those who believe **Castaneda** to be a pseudo-shamanic storyteller should soberly compare the description given by Don Juan of the path taken by the early sorcerers of his tradition, of how at the critical threshold of the Eagle's spiritual Aerie they suddenly realized that all the strategy of their energy-acquisition came to naught—that they'd been barking up the wrong metaphorical tree so that a discontinuous transformation of Being was called for, independent of any of their feed-in paths of identification.

Though here the Ra material has progressively less to say, initiated thought would have you understand that a minimal threshold level of coherence has been accomplished up to this point to stabilize the currents, universalize and integrate the subconscious energy-complexes in congruence with the conscious axis so as to allow the basic force of identity to be fixed between the coordinates of

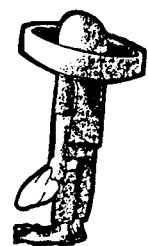
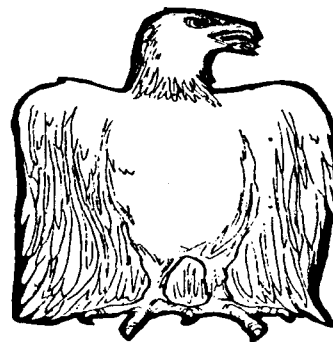

Balance. The value of identity itself henceforth, from 5th density onward, becomes the key and all Creative patterns are understood in its whole and moveless light.

At the level of mind-body integral coherence and threshold intensification required for the basic transference of operative Principles at 5th density, the factor of attention is less significantly subject to variable "openings" through the inviting void-potential of ducts and psychic wormholes (proffering deep dimensions of energy-nutrient in exchange for caretakership and cultivation—or, in the case of the negative being, exploitation and plunder). The instrument of attention (which functions largely as the "periscope" of awareness) has settled into close correspondence with the basic, quickened force of whole-value identity established as the universal locus or common denominator in the convergence of compositional coordinates distinctly resolved as a powerfully intensified and stable Void-point.

In the form of the universal, convergent void-point, the value of Identity constitutes a kind of equivalency-by-identification with the axial model of "vehicularized" life or bodily-being altogether. Identity has not been lifted gently from *between* the coordinates of Balance as it is in 6th density (or in the 6th stage of realization belonging to the higher adepts incarnate in 3rd density); it is fixed as the radial locus of all polarized terms, harmonized in a global resolution of self-adjusting Equilibration. Identity functions then at 5th-density level as the apotheosis of Limit; as such it is identified with and as the creative principle Itself, for all the teeming universes of creativity spring in the first place from the prototypal power of the Illimitable to accommodate the apparent "antithesis" of limitation.

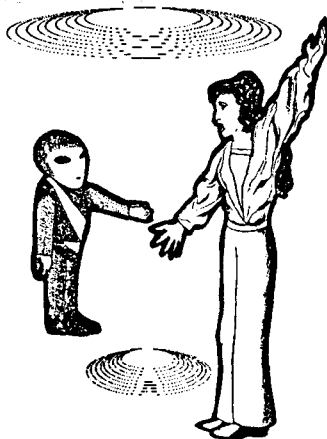

Therefore, 5th density is the spiritual-light zone of learning for "embodied" beings who work directly with and through the creative patterns of Mind, the whole-point value of void Identity serving as the unerring, always-conscious resolving Principle of each formulated pattern furnishing the optimum axis of Balance.

The positively-polarized being of 5th density acknowledges the *constituted* character of the resultant, equilibrated void-point of Identity deposited as the central spiritual "residue" of self-cancelling coordinate extremes, thereby assuming the orientation of service toward the constituting Whole without center or delimiting circumference; the negative being of 5th density accepts that universal convergence in self-cancelling centrism as indication of the way in which all things *are constituted* to serve its Identity, upsurging as the common "product" of all cross-correlation and synthesis.

Thus both positive and negative beings of 5th density tend to "remain in place", and from that point of rest in Identity through the creative light zones emanate archetypal patterns as a kind of co-creative function to be adapted according to the interpretive terms of the lower densities and planes, as causative Influence. The positive beings project patterns of the creative archetypes that tend to promote harmony and peace; the negative beings project patterns that serve to tailor the astral and physical forms of conflict, disease and discordance.

Thus the soul-complex does not "travel" any longer as it did in 4th density, nor does it *seek* in that sense ever again, but only practices the alignment of all creative patterns in congruence with the self-evident, standout Value of Identity clearly furnishing the common term of all dimensional coordinates.

The 5th density is indeed the density corresponding (in "embodied" or soul-concentrate form) to the Macrocosmic Heaven-realm of the Creative Itself. Here all the cosmic patterns of expression

in their potential dimensionality and variable, compound focal-alignments shimmer like a great crystal, an illimitable metacosmic Jewel. It is from this level, reflected into the spiritualized Mind of 3rd-density being through the consciousness of a 5th-stage master (the realized *stages* of 3rd density "embodied spiritual masters" correspond, by resonant harmonics, to the like-numbered densities), that we receive the lustrous descriptions of the Buddha realms, the Taoist Mountains and myriad Transformation Bodies, the infinite creative scapes of "jeweled pavilions" and "strung pearl nets" multiplied endlessly in mirrored reflection through each of their incomparable facets etc.

Cosmic Smerfs: Here Come the Space-Dorks

Note: it is the vision of this great, Creative Crystal, as well as the concomitant vision of the Eagle, to which the little gray space beings introduce **Betty Andreasson** in *The Andreasson Affair*. The distressing "strangeness" of **Andreasson's** interdimensional experience at this point of the narrative that so tended to put off her credentialed colleagues, *precisely* specifies the nature of the ordeal as that of having been taken to the very threshold of 4th density "astral" or cosmic-plane reality, abutting the Archetypal force-forms projected from the ledge of Fifth Density. It is unexplained in the book (indeed it is simply too perplexing for all those involved) but the *purpose* of the beings having exposed **Andreasson** to such an unbearably crushing intensity—see **Castaneda's** very similar accounts of intolerable pressure in the attempt to physically cross such threshold zones—was that of satisfying their collective, social-memory-complex curiosity as to how much of the Creator-Presence a *heart-being* of the earth plane could take after the several light-adjustments and technical alignments received in their craft.

Although these little bug-eyed beings involved in the **Andreasson** event are of the "positive" polarization-alignment despite their similarity to the negative grays, they exhibit the typical development of systems which deemphasize the median *heart-center* or dimension of psychic Love, so that in practical fact they are aligned with Cosmic Law but restricted in their Search for the Creator by just that comparative lack of heart-embrace; it is for this reason that they took **Andreasson** on several occasions to the "locale" (in terms of Astral 4th-density coordinates) of the Macrocosmic or Creative God-power, where that Presence seems to specifically concentrate and open out the psychic density as a great Door, or push through as a nodal eminence in the form of a glowing Dome etc. Whereas they themselves, in the limits of their interminable 4th density seeking, will not "walk" directly into the Locus of that Presence, they have no compunction about pushing **Andreasson** into it as far as she can go.

This apparent deficiency in the development of the heart center with respect to "spacebeings" of the 4th density has been noted in several sources; we may even find in **Meher Baba's God Speaks** a reference to the fact that "earth" is uniquely a locus or spiritual training ground for the full development of that center, and that beings of other systems and galaxies lacking such opportunity covet the experience to be gained from the lessons of earth-consciousness. From this we may interpret the nature of what the **Andreasson**-beings meant to observe through her ordeals with the burning Eagle or Hawk and the breath-taking Crystal etc.

Due to the character of our traditional spiritual and esoteric teachings, we may have a conceptual difficulty understanding how a being of a higher density (especially one which is represented as involving the value of Love itself in its basic lessons) manages to acquire its status without benefit of any basic heart-development. Such beings (of a positive character) have achieved the necessary intensity and developmental alignment adequate to 4th density polarization, through conscious decisions based on recognition of the abstract propriety and promotional advisability of peaceful values, cooperative characteristics and strict adherence to identifiable divine law. Thus beings such as are encountered in the *Andreasson Affair*, display a recognizably "scientific" approach to spiritual considera-

tions; they openly regard Divine Light as a measurable magnitude, actually quantifying the presence of "religious merit" so that for example when in a moment of fear **Andreasson** protests that she is "full of the Light", they show her "X-ray slides" of the precise ways in which she is not (they also subject her to certain gentle processes of light-balancing to amend the "breaks"). Their apparent "coldness" or objectivity in even the warmest, most "psychically alive" of astral-like circumstances does not prevent them from registering any inadvertent distress they might be causing their "captive", and modifying their approach accordingly.

If this seems minimally gratifying in light of the fact that the incident is, after all, one of those increasingly common accounts of UFO abduction, the "victim" seeming to be forced to endure such non-ordinary experience through no decision of her own, one need only compare the behavior of truly *negative* beings in superficially similar circumstances in order to appreciate the difference. In the famous accounts of **Whitley Strieber** regarding his ongoing *history* of bizarre abduction we have an adequate example with which to contrast the **Andreasson** description.

Smerfs-Up: Here Come the Gremmies

The **Strieber** entities make no bones about the pleasure they derive in causing him stress; juxtaposed against the **Andreasson** grays, the latter are nearly innocuous. Rather than the apologetic withdrawal and prompt provision of liquid "balms" (that induce a kind of overriding bliss) as with the **Andreasson** entities, the **Strieber** marauders furnish graphic illustration of what the **Ra** material describes (according to abstract principles) with respect to the higher-density Negative Being.

What then of the seemingly execrable, indeed unthinkable fact that both accounts revolve around *abduction* scenarios which with equal, peremptory efficiency seem to deprive the subject of precisely that *free will* factor so central to the preservation of spiritual integrity as outlined in the **Ra** material?

Even that material suggests that, *very rarely*, members of the Confederation (the higher-density Good Guys) are involved by Permission in such abductions, or Close Encounters of the fourth kind. However, **Ra** suggests without specifying that these apparent psychophysical "kidnappings" do not at their deepest level violate the free-will factor, and are occasionally though not often considered to be serviceable in the direction of positive polarization. How can this be? All one really need do is conscientiously compare the respective texts, i.e. **Andreasson's** and **Strieber's**; initiated understanding will furnish the conceptual characterization of what's inevitably intuited or vaguely felt when weighing these accounts against one another.

In the **Andreasson** case, we are always given the impression that, despite her overt fear and often terror at the sheer strangeness of the situation the beings are always doing something of a telepathic or quasi-physical nature to put her at ease; there is even the sense, reported by **Andreasson** herself, that at some deep level this is taking place in *conformance* with her will and not against it, as if in some way it had been *prearranged*. In contrast, *discomfort* of a deliberate kind almost consistently characterizes **Strieber's** account, and he is made to feel very overtly like a specimen humiliatingly observed and manipulated. He is even laughed at. There is in **Strieber's** case no *underlying* sense of complicity, of a prearranged concordance between dimensions of the deeper volitional being perhaps belonging to the planning-boards of Dream and the intensified volitional level of the entities themselves; rather, there is something much more distressing. And that distressing note develops in the course of **Strieber's** writing his accounts.

Rather than any *a priori* sense of soul-compliance, there is evidenced a progressive, *after-the-fact-rationalization* as if the negative intensity of the experience were too much to bear, and the implications too stressful to contemplate. In **Strieber's** account we witness the astonishing (but, under the circumstances, under-

standable) effort to *transmute* those horrific experiences into an ego-positive outline. Thus **Strieber** with almost excruciating transparency invokes the standard "humanistic" saw to the effect that dichotomies of good-and-evil are too simplistic and medieval, truth always being some "gray" blend of opposites; in this way he shields from himself the obvious implications of his ongoing ordeal. But more importantly, he demonstrates to perfection how one procedurally "falls into the hands" of the Negative Beings and, by the self-protective mechanisms of 3rd-density psychology engineers a reversal of assurance to the effect that "good" things, developmental things positively proceed from such ordeals—thereby underwriting *a posteriori* through the work of his own will the things which can't be "taken back" from the memory-banks and so seem to require some cover sufficiently assuaging of any ego-damage done through that quality of helplessness dripping, like absinthe, from the bitter cup of his plain victimization.

But other messages echo through **Strieber's** lines, much more powerful and persistent messages. "Why do you hate me?" was the first expression to which he gave rise in the recovery of his initial "abduction memory-print"; he reiterates over and over, in both *Communion* and *Transformation*, that despite everything he can't overcome the feeling that "they" are totally negative, just plain evil and monstrous. Yet his conclusions, his occasional distillates of what so far he's learned insist almost schizophrenically that these entities must in some way have the "good of mankind" at heart, that through the apparent terrorism of their utterly unworldly appearance and vile behavior they function something on the order of "cosmic zen masters" (as one commentator inferred from **Strieber's** account) taking a hard stick to our stubborn skulls so as to crack them of their crippling insularity. As "proof" of the actually liberative work they're performing, **Strieber** invokes the fact that owing to his jarring experiences he's "come loose" and is able to sample in waking consciousness the phenomenon of *astral travel*.

This shouldn't be so heartening, if properly understood.

Strieber's inventory of "positive side effects" on the whole describe a definitive list of what would be characterized in the **Ra** material as distinct inroads in the Negative program of conquest and ultimate Soul-capture. Like diabolical chessmen, **Strieber** inadvertently shows that the "spacebeings" have maneuvered and bullied his thoroughly beleaguered psyche into actively *choosing* the hypothesis with which they've implicitly enveloped him. He has accepted fear, for example, as a legitimate "tool" of deliberate spiritual "teaching" (which is very curious, since **Strieber's** hearty endorsement is prominently displayed on the dustjacket of **Kenneth X. Carey's** *Return of the Bird Tribes*, a "channeled" book which has as its most distinct and repeated message that *Love* must become the accepted educational mode of consciousness *and not fear*—do we detect **Whitley's** furtive effort to humble himself before a principle opposite of that which he openly espouses? or is there something more deliberately subversive here—one tactic of the Negative Beings, after all, is to find a means of subtly allying their Message with that of the truly Positive so as to generate confusion in untrained minds which would tend on surface evidence to accept these actually contrary messages as equivalent).



In further "defending" his tormentors and interpreting their tactics as a strict but ultimately benevolent discipline(!), Strieber helpfully displays for us one of the common vulnerabilities on which the Negative tactic counts, as a kind of hook upon which the Soul is sure to be snagged save by the unlikely event of a real egoic "repentance"; for indeed there is not *just* the sorrowful, cringing form of victimization to be found in the Strieber profile cast as a shadow on the psychic wall of his verbal edifice. There is also the distinct, burning ember of ego, the persistent glow of an intellectual pride which refuses to be counseled when the counsel seems to touch too close to truth; for any suggestion that his entities are plain evil seems to cause him to clutch his experiences the more covetously, and guard their interpretation jealously from any who might have a revealing word (which would in effect displace their proprietorship onto the overlapping circle of another ego). He proclaims over and again, all too often to remain marginal, that no one can explain his experiences to him since they're uniquely his, that anyone with an interpretation ipso facto has an axe to grind or approaches from the Procrustean perspective of preformulated concept, doctrine or theory; and that finally, his intellectual superiority makes him uniquely qualified to pioneer this field which he acknowledges sharing with other "abductees" (inferentially, not so well qualified).

It is this type of rationalization and self-protective recoil upon which the Negative design counts; for it is these internal properties of 3rd stage consciousness which serve all too predictably to convert scenarios of real coercion, flagrant violation of free will and worse, into occasions of egoic appropriation magically transforming the imprisonment of will into a full volitional acceptance. So Strieber seems to accept on principle the methodology and meaning with which he was harrowed, the Weltanschauung through which he was seized, defending it in full Will like a snapping terrier coveting its terrible bone against all comers; and that is too bad, because by his own account and according to his public history he is a man of gentle instinct and kind, overtly benevolent traits. He has written of his concern for nuclear disarmament, and thus of his concern for humanity; and he has given every indication of being a conscientious father (whose son, nonetheless, has become deeply involved in this unsavory business according to what was recounted in *Transformation*).

Planetary Quarantine and the Divine Dice

The natural question to ask, then, is how is it (considering factors of "karma" and psychic "laws" of like attracting like etc.) that an apparently positively-inclined personality such as Strieber should be so confoundingly caught up in the net of Negativity which he details? Isn't his tendency toward "goodness" enough? Is there some unknown element involved in all this, which accounts for the seeming collapse of protection that ought to surround a "good man"?

In fact, though this saga spans dimensions and takes place principally on a spiritual level, we may suggest that the same factors apply which govern those grim circumstances wherein very good and innocent people went to the ovens in Nazi Germany—and indeed which presided at all such similar outrages recorded in our mystifying planetary history.

The answer to this question is going to be disturbing, particularly for all those who believe that their day-to-day "niceness" is enough, a kind of talisman like the universal sign of the cross that automatically "repels" negativity and sends it to the door of the less deserving.

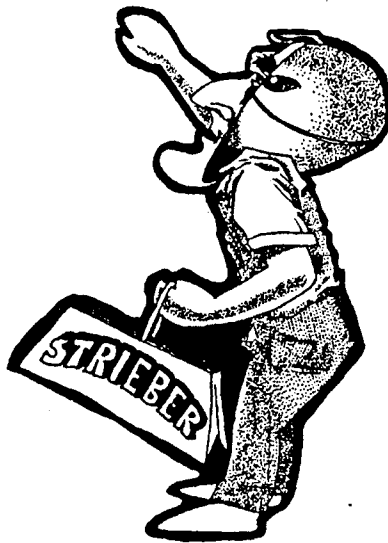

Initiated understanding knows of principles besides those of "karma", which govern the cycling of events (as if "karma" were some heartening explanation that kept the wolf from one's door, owing to the likelihood of one's unblemished reincarnational past!) There is also a random factor, something very much akin to the revolution of a roulette wheel or the occasional synchronization of—arbitrarily calibrated—stroboscopic pulses. The random factor in the lives of beings is very much like a cosmic manifestation of the principle of free will; it is in fact an expression of the underlying *conscious indeterminacy* which informs, and indeed permits, the variable coordination of complex lines of tendency and preconditioning we take to be fixed or fated patterns.

The random factor flickers over our lives as a particular kind of catalytic agent; its existence, *through* the principle of indeterminacy, furnishes an unpredictable variety and therefore multiplies by an exponent the numbers and types of experience through which we're given the opportunity of soul growth, freeing such possibility from an otherwise strict limitation to "causal input", or those wheels which are already set in motion by our will.

Such a random factor is described in the Ra material in the discussion regarding *planetary quarantine*, or the means established by the Confederation to block out of the vulnerable matrix of enforced, 3rd density limitations any *undue* influence that would infringe on the factor of free will. An undue influence would of course be that of the Orions (the name Ra gives collectively to the Negative Beings of the higher densities, though not all negative beings are from the etheric locus of Orion); for the Orion Crusaders as they're called proceed precisely by plunder, and do not observe the positive proprieties of, for example, waiting until there is a distinct call put out for their "services".

Their method is, by tendency, to *coerce* the capitulation of "free will" thus in effect adhering to the letter of the Law while violating its spirit (through those means and in the manner previously described). Thus a compromise balance is struck by the positive "law enforcement officials" of the Confederation, honoring the spiritual requirement to allow for the Orions' negative interpretation of the "first distortion of the Law of One" as Ra puts it, i.e. the Law of Confusion or free will. The free will of the Orion Crusaders to plunder and *impose* their influence wherever possible is furnished a minimal aperture through which to vent its impulse, the random and ideally infrequent "holes" in the kaleidoscopic webwork of Quarantine thrown about the 3rd density earth-sphere. This random factor is also conceived to supply an indeterminate term in the supplementation of "catalyst" which is otherwise largely laid out upon the well-worn tracks of "karma" or previous conditioning.

The ideal *minimizing* of this opportunity afforded the Orion Empire—having to time its predacious leaps through the infinitesimal calculations of light-wave synchronism whereby the void-channels opening earthward irregularly "pucker"—establishes under ordinary conditions a satisfactory ratio of balance between the free will "needs" of the Negative Beings, and the free will requirements of 3rd density incarnate consciousness (inordinately vulnerable due to the deliberate, encoded blindness accompanying the critical choice of a "test-dimension" specifically shielded from direct perception of void-nature as a unitive and intelligent continuum).

Cattle Call

Indeed, the only means of *waiving* the light-strictures of Quarantine revolves around the requirement of honoring the in-

tegrity of free will; thus when there is a specific *calling* from the dimension of 3rd density consciousness (i.e. a coherent and sustained psychic *request* either pointed or implicit for certain types of information, "positive" or "negative" depending on the type of knowledge or the character of those making the request) either positive or negative forces of the higher densities may respond according to kind coming straight through the Quarantine envelope.

A "pointed" request would be that of a magical ritual specifically invoking powers and intelligences, whether "white" or "black"; an "implicit" request would be that of, for example, a prolonged brooding either personally or collectively over certain dilemmas of existence that loan themselves to central issues of value, meaning, purpose, the nature and destiny of Being etc. From this it may be inferred that there is one way of *breaking* the primary balance in the cover of Quarantine. That balance can't be violated from *without* by either positive or negative forces; but the collective character, over a prolonged span of time, of the net aggregate *calling* rising up from 3rd density consciousness, whether on balance predominantly positive or negative, *can* modify that initial formulaic ratio of equity. The quality, integrity, persistence and numerical composition of the "call" are the variable factors that determine the net value of all calling positive or negative.

The "physical" disturbances that may be said to contribute to a disruption of the Shield such as underground nuclear testing or atmospheric detonation of nuclear devices, the negative employment of certain "secret" superweapons of a scalar or etheric-energy type, the devastation of the ecology through petrochemical mismanagement etc. may actually be understood as perceivable manifestations or concrete "symbols" of a psychic orientation toward great negativity, with a concomitant "calling" requesting the most powerful means or knowledge of exploitation, dominion and enslavement. To this call, the Negative most obligingly comes.

This distressing situation accounts for the alarming increase in the incidence of nonordinary or invasive negativity of a conscious type (an increase of which we are just becoming aware, as if it's steadily percolating to the surface of mass apprehension from the subconscious shadows and hypnagogic half-lights where for many decades of sinister incubation it has lurked—cf. **Budd Hopkins' *The Intruder's***, **Whitley Strieber's *Communion and Transformation*** etc.). It seems in fact that we can date the evidence of an accelerated Negative calling from approximately 1945, or the year of the fateful decimation of a human populace by atomic weaponry. (Another and more direct incident ensued by just several years, which served to crystallize the calling—of this, more in the next issue of *The New Thunderbird Chronicle*).

Couple this knowledge with our previous explanation of the *densities* and we have a prospect pushing so hard upon the general threshold of awareness that it seems even now to send many off-whistling in the dark of a nervous denial.

After all, we've received knowledge enough of both physical and metaphysical types to understand the basic principle of the "densities", i.e. that all dimensions, planes and states may coexist through a given point; that any such point is geometrically "saturated", a focal expression of creative vitality alive with the potential coordinates of force and form that essentially overlap, interpenetrate and coinhere—and which may be artificially separated into the "discrete" dimensions and planes of experience by specific, axial polarizations comprising the perceptual grid-network of a given system aligned through the informing pattern of the ideotype (logos or sub-logos). This shows that there is basically nothing standing "between" beings of any given plane and any other except the filtrate screen of perceptual coordinates through which the "perceiver" operates. Considering that the 3rd density with which earth-consciousness is collectively identified is uniquely "screened" from direct perception of the informing dimensions of energy, pattern and light functioning overtly through the spiritual value of Void-being, it be-



comes apparent that physically focused life is lived through the one-way permeability of a veritable cosmic fishbowl. We inferentially exist as an aquarium variety that can be viewed, unobtrusively scanned at leisure by all forms of self-reflective consciousness existing through the higher densities and dimensions either "positive" or "negative"; and we in turn see nothing, even to the degree that we can (and must) ask the question "Is there anything out there?"

The very idea of this makes many people squeamish. As if it weren't bad enough to be transparent to eyes of a *benign* character operating through the higher planes, *now* we have to be told that the greater dimensions of spiritual existence beyond the physical do not just host the law-keeping legions of positive beatitude. It's one thing to accept that some Santa Claus-countenance might be beaming down upon our blindered peccadillos with a disapproving cluck of the all-forgiving Tongue that, after all, resonates to the Divine Word; it's quite another to have to confront the prospect of some basically *malevolent* intelligence, of a purely conscious and calculated, predatory wisdom far more than just a match for any homegrown 3rd density mentality, moving freely with catspaw quietude through the porous fog of the dimensional interstices, gliding surreptitiously around and through the concrete objects that so peremptorily outline *our* limits, sidling next to us—invisible shoulder to quite vulnerably-solid shoulder—and whispering hemlock-sweet overtures into our defenseless ear (overtures that ooze with subliminal ease into the ongoing complex of our motivations, passed right by the crude monitor of our physically-oriented focus without registering a blink).

So unacceptable is this prospect to the 3rd stage ego (scarcely integrated to a degree where anything but anxiety can be its counselor), that it plunges for the veto-button, foaming denial with a frenzy able to reach—in indiscriminate recall—for every churchly word of whatever denomination or faith that ever intimated only the "good" pass on to the afterworld.

Indeed, part of the "confusion" of these comparative channeled accounts is that such reaction finds certain comfort in passages taken even from the better sources, so that for example, against the excellence of the Ra account the word of the *Bird-tribe* council may be juxtaposed to the effect that negative values and thoughts of warfare can't be brought along into the higher realms. Such sources would specifically have us believe that the basic identity of things as disclosed in the common denominator of the Void-light, *compel* a conscious conformance to the values implied in such unmistakably unitive modes.

Sticking to Your Guns

Just a little reflection, however, should wobble any such presumption; for no 3rd density scientist (for example) seems automatically constrained to "good works" by his own evidence that the elements operate through a mutually defining network of closely integrated properties and unitive principles. The objection to this, of course, is that the comparative perceptual "samadhi" of a 4th density magnitude would tend to subvert the dualistic underpinnings of the psychological structure—characteristic of 3rd density—that permits a persistent *behavioral* conformance to its divisive claims while allowing free rational admission of an underlying unity of Being.

However, self-recoiled ego-identification is at bottom a *conscious preference* rather than a provisional mechanical constraint, and this is *proven* precisely in the higher densities where there is no longer a polarized lock-in enforcing a linear and abstractly distancing—or rhetically "dividing"—left brain emphasis; at these accelerated levels, the adherence to divisive egoism in the face of the unitive Void-field is a manifest expression of will, and can *only* be the resort of a very conscious intent (i.e. it can no longer be "excused" as the subconscious habit-pattern of the enculturated nervous system). The clear decision to lurk and prey behind the overt holism and ecstatic oneness of reality, using that spiritual love-continuity in fact as a camouflage through which to install oneself by stealth, becomes self-evidently the option of a *conscious being only* (for the beings of 3rd density, no matter how "negative" they may be behaviorally, are not conscious—as 3rd stage beings—of the unitive holism of Void-nature and so do not *have* that value as an option to include in their calculations).

This accounts, for example, for the confusion **Strieber** feels in confrontation with his tormenting entities; as merciless as they are toward him, he feels the presence of *love* rather strongly when around them. This in conjunction with the compensatory mechanisms of psychological fear-reaction help lead him to conclude that they must be at bottom or in some way "good", and have mankind's welfare at heart. What **Strieber** *feels* in their presence is the informing quality of the density through which they characteristically function, i.e. the Love-density of the 4th stage. However, he fails to realize the manner in which this Love-unity-feeling is the pervasive property of that density (to which he is temporarily exposed in his abduction), *not* the personal expression of the beings—except insofar as they consciously invert the love-value of that density upon the shadowy, nucleated outlines of their intentionally preserved, egoic brand of selfhood. However, the beings *rely* on the general Love-feeling of that density to confuse the issue, to befool the bedeviled mind into taking psychological refuge in a self-protective premise that will further encourage the acceptance of their most coercive behaviors as reverse-twist exemplifications of the general rule of "love".

Why then do even otherwise "good" sources in the general category of channeled material sometimes speak to the effect that nothing negative can move on to the higher planes or stages of development?

What You Don't Know...

First of all, of course, the character of the *channeler himself* has to be taken into account along with all his preconditioning and personal limitation. The channeled source often *transcends* those limits, if it is a good and strongly aligned source; but it may also make use of those limits. In the case for example of the **Bird-tribe** source which **Ken Carey** channeled, we find illustration of a certain benign "contention" or division in methodology belonging to the higher 4th-density plane; for it should be understood that 4th density sources (of which **Carey's** is one) function through a *variety* of concepts as to which "approach" would be most practical and productive in raising 3rd-density consciousness. There is no absolute agreement in the 4th density even amongst positive groups of intelligent service. **Carey's** source is simply demonstrating, in its explanations, the decision to

address a certain type of 3rd-density consciousness through his particular style of ideological limitation, by focusing only on the principles of "positive" polarization and in effect denying or bypassing the "negative".

This conforms to a certain belief-pattern prevalent in New Age circles and "used" or supplemented by occasional 4th-density sources disposed to take the "see-no-evil" approach; such doctrine runs to the effect that where there is no knowledge of negativity, negativity does not exist. This in turn links to a rather bumptious corollary in the theorems of certain New Age schools and "astral" fields of inquiry, i.e. that of "you create your own reality" (see next month's *T-Bird Chronicle* for the article that addresses this issue).

The defect in such reasoning would be clear even to those who subscribe to it, if it wasn't put in terms of "spirituality" (which makes it still too nebulous and unreal, frankly, for those even who purport to subscribe to all sorts of "spiritual" New Age principles) but in simple, easily identifiable terms of physical existence. Thus, if it were a matter of warning against something like the formation of *Hitler's Nazi Germany* as a quite real stormcloud looming over the horizon, very few today would take the Chamberlain approach and imitate the proverbial ostrich. However, when it comes to negativity of a *spiritual* character many (including beings of the 4th density) assume some special attitude: from the physical perspective, the assumption is that "spiritual" and "physical" have different roots; from the astral perspective the assumption proceeds out of a kind of intoxication that "forgets", or never knew, the difficult ambiguity and admixture of physical life.

Now, if *karma* were really a simplistic matter of the type popularly professed and only "negatively disposed" beings or those with blemished records were vulnerable to any potential incursion by negative forces, *perhaps* we could see some minor virtue in not troubling all those "good" heads over such contretemps. But this is still not the same as *denying* the existence of such evil outright; and in any case one could never know in the depths of one's "personal karmic record" whether there weren't some lingering mark that might compromise one's perfect dissociation from such business. But "karma" is *not* that simplistic; the global slate of the breath-soul upon which karmic marks are recorded, requires that *blank spaces* be filled in as well as existent entries balanced. Thus, vacuums of experience (especially those experiences or potentials deliberately avoided) possess a magnetic urgency to be filled; and where *avoidance* indeed accounts for the vacuum, there the random factor which we've previously discussed becomes an ever-more-likely catalytic agent as opposed to any head-on initiative of personal will (which would, of course, create proportionately more "governable" circumstances).

It is for this reason that the education of 3rd density consciousness to the existence of real negativity, to the ways of such negativity even to the characterization of its existence as far as the degree of true spiritual (because *conscious*) evil, is considered appropriate and even necessary by the alternative viewpoint of higher-density consciousness. Such Consciousness looks at the ostrich approach as a disservice, and as very *short-sighted* even where clothed in the apparent sanction of an "astral" or 4th density communication. (Even **Pollyanna** acknowledged the existence of negativity; she never denied it, just emphasized the positive. That's hardly the same thing as dismissing the negative in neo-Augustinian manner as a "non-entity", as a fugitive shadow definable only in the "absence of the good"—which falls to the standard liberal sop of educating all beings out of their "contrary ways" since the negative can only be sustained in the presence of *ignorance*. Such doctrine has *no idea* what to do with an evil that isn't simply "relative to cultural context" or comparative definition, and which functions not through ignorance but—to the contrary—on very *conscious intent*, by highly intelligent preference).



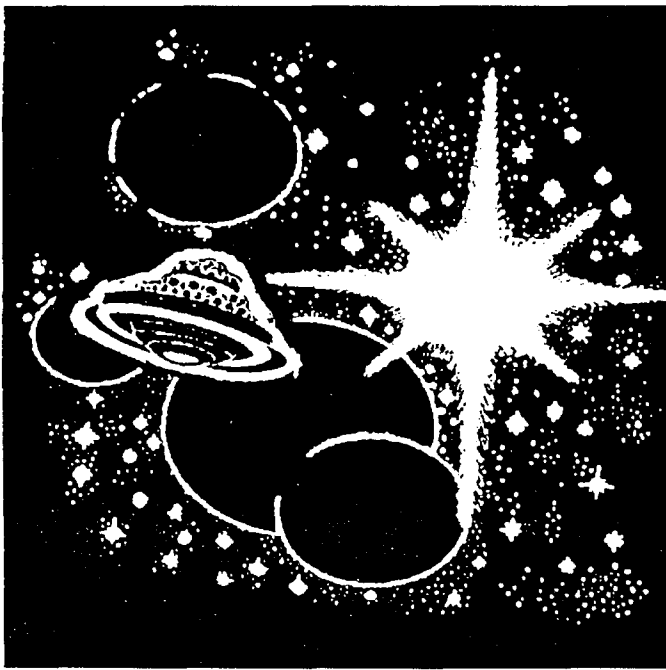

PART TWO

Love Was All He Said

The alternate convention to which a certain "New Age" mentality turns whenever the possible existence of an actual, deliberate negativity approaches the unimpeachable, is that of the vaguely "Christian" tactic: love-bomb the blighters until they see the error of their ways, by the point-scoring Good Example set. Such cheek-turning is in practice of course a very selective espousal, since it rarely seems to constitute the day-by-day *business* attitude of the very same proponent. Even in the case however that this recommendation weren't outright hypocrisy, it would remain fatally fatuous; for, as the Ra entity proclaims to one of the questioners who presented just such a tidy "solution", they (the Orions) "do not want your love".

This rebuff clearly meant that any "love-rays" directed toward the zones of Conscious or Spiritual Negativity would find nothing receptive on which to fall, no substance upon which to work. The inescapable implication was that *any* such proposal, suitable enough perhaps for beings of a straight *3rd-density* consciousness not decisively polarized and therefore still possessing a "recessed trait" of potential goodness able to be acted upon, when applied toward Spiritual Negativity of the Higher Densities simply served as clear indication that its proponent hadn't understood the point.

The Negativity of the Higher Densities is *ipso facto* awake; it has *chosen* the rejection of other-love as a whole-being orientation, and therefore has no subconscious residuum of receptivity that might secretly "respond" to the good intentions of a positively-directed beam (even if such a beam proceeded from a sincere resolve which consistently applied its Samaritan counsel in all other avenues of life).

Indeed there is deeper implication than this. In the face of such *uncommon* or truly *spiritual negativity* the presumption of such conventional counsel (applicable enough at the *ordinary* level) might well result in consequences worse than simple "lack of success". It has to be understood that spiritual principles and religious precepts, even those cherished from long use and universal recommendation are at best optimum advice for the given system of function; at the transition

to general 4th-density existence, those precepts and principles most apparently "eternal truths"—as they stem alike from Buddhism and Hinduism, Christianity and Sufism—have to be evaluated against an enlarged context, and modified according to the forms of information "unique" to the higher domains to which consciousness must adapt.

The principle to "love one and all alike", to bestow "blessings upon all beings" and so forth is not subject to *abandonment* at this stage; we are not to somehow understand that a reversion to hatred and warfare are suddenly "all right" due to the extenuating circumstance that "pure spiritual evil does indeed exist". Universal Love is and always remains the principle in some proper form; but the *specific* beaming of the "love-vibe" in the direction of the Orion Crusaders not only possesses the defect of wholly wasted effort; the philosophy informing it tends to contribute to a tremendous *misreading* of the elements actually involved. And this is no better illustrated than in the Strieber account of the manner in which he was made to feel tremendously *guilty* for not having obeyed a direct command of his tormentors.

Sweet Setup

In *Transformation* he recounts the otherworldly interdiction whereby a "voice" bade him refrain forever from sweets, his one true vice. Addicted as he was, Strieber couldn't stop, even though the "beings" engineered circumstances so as to bombard him with dire implications. As a result, one evening he is visited by a malevolent presence which he himself—as always—describes best, i.e. as "monstrously ugly, so filthy and dark and sinister. Of course they were demons. They had to be." Again, "the sense of being *infested* was powerful and awful. It was as if the whole house were full of filthy, stinking insects the size of tigers." The entity, rising up beside his bed like a "huge, predatory spider", places something at his "forehead" (i.e. the Third Eye) and with an electric tingle he is "transported" to a dungeon-like place where his attention is fixed upon a scene of excruciating torture. The victim, a normal-looking though quite naked man, is being whipped to shreds amidst agonized screams by a cowed figure. His "entity" explains to him that "he failed to get you to obey him and now he must bear the consequences". This disclosure is followed by a very *interesting* and *significant* "assurance" that "it isn't real, Whitty, it isn't real." As Strieber reports, such an "admission" did nothing to mollify his horror.

The assurance was indeed an oblique reference to the actual tactic being used by his tormentors; the whole scene, like so much UFO-abduction data, is a projected *thought-form*. Such thought-forms are generated not in or through our ordinary "3rd-density" plane, but are manufactured in the medium proper to them, i.e. the Astral. The subject, then, is either spirited to the "vibratory frequency" of that density through dissociation of the astral vehicle from the physical, or, as in certain accounts possessing a component of "high strangeness" the 4th-density menstroom is tuned into place by a vertical adjustment and wholesale realignment of the nested "bodies", in such a way that the subject doesn't *dissociate* from the integument of "touch" (and thus, from the physical-electric grid) but rather undergoes the rotation of the coordinates of that grid so that they line up in conductive relation to the informing geometries of astro-etheric patterning which otherwise are obliquely screened—thus affording a direct continuity of perception surcharging the apparently "preserved", familiar field of physical focus with impossible Whitley-in-Wonderland elements.

The purpose of soothing Strieber with such assurance as to the ultimate unreality of the convincing scene experienced, should be familiar to anyone who's heard of the torture tactics employed in any good Banana Republic (i.e. those in which the victim is subjected to excruciating pain on the one hand while being simultaneously stroked and reassured on the other, often by the same party). The object is to elicit the full cooperation of the victim under duress, by making him instinctively gravitate toward the implicit salvation extended

through the “motherly” touch demonstrated in that schizoid Grasp, feeling some surcease and thus even affectional Gratitude with respect to that one factor in the whole horrible stew that seems to proffer kindness and a relieving recourse.

Indeed, **Strieber** proves himself the compliant guinea pig; even under the intelligence that it's all a thought-form, his compassion for the (imagistically dramatized) unsuccessful “bidder” persists, obviously in thorough confusion with his own self-commiseration, so that finally he collapses upon a repentant love for the very roaches that bedevil him. “Again, though, I felt love. Despite all the ugliness and the terrible things that had been done, I found myself longing for them, missing them! How was this possible?”. Again, “I regretted the contempt I had shown for its [the *other* “reality’s”] needs and its laws and felt a desperate desire to make amends.” “I had felt a pain greater than the pain of punishment. It was the pain of their love....I had the sense that they had on my behalf turned away from perfect love, and that they had done this to help me.” “I suspect that the ugliness I had seen last night was not them, but *me*. I was so ashamed of myself that I almost retched.”

In this way we may clearly see the baited hook that awaits within a context *inclusive of life in the higher densities*, with respect to the word of universal-indiscriminate love. The effort to operate such love according to a literal interpretation of the word, is ripe to be employed as a real booby trap for any form of consciousness having as yet *no practical grasp* of the Whole, and so by virtue of standard habits of identification chronically confounding the Whole and the part (as is the typical pattern of 3rd density mind). Unable to “see” the Whole which nonetheless directly *infuses* and underscores the negative entities as their very medium, clinging to their foulness like a sweet masking scent, the mind used to dealing only in terms of the representative part is unusually open to making just that identity-equation in which the incidental *expression* of a Field is presumed to contain that field, or is taken as one-to-one equivalent of the quality belonging to the field as a whole. Conversely, the *return* of the Love-value toward any being of such a field *isolated out of the context of the Whole*, tends—to the mind chronically focused only on the complex relation of part to psychological part and never on the Whole itself—to be but a yielding or block submission to the other’s requirements as means of overcoming the resistance of “identification”.

To the Highest Bidder

Should there remain a reluctance to grasp this point, or some desire to conserve the liberal-humanistic proposal to which **Strieber** often turns (i.e., to call such things truly Negative or Evil is “simplistic”, you know) we need merely resort to the **Ra** material once more, wherein we find a passage—first published in 1981, don’t forget—that anticipates **Strieber’s** account by years and furnishes a framework *before the fact* which not only fits the **Strieber-entities’** behaviors like a key a lock but gives us a needed perspective of *evaluation*.

On page 21 of Volume III, *The Law Of One*, the **Ra** entity characterizes a prototypical tactic of the Orion Crusaders, that of “bidding”; “bidding” is described in such a way as to make it clear that **Strieber’s** experience represents a concrete instance of the phenomenon, a factual case history with which to footnote **Ra’s** words. “Bidding” is a contest of will, serviceable in determining the pecking order of the social-memory-complex of the Crusaders, and in rendering the general run of consciousness enslaved through intimidated compliance of its own free will. It is a *command of obedience*, precisely such as that issued without explanation against **Strieber’s** lust for sweets. Its sole purpose is to bend the subject into accepting the command, the actual *content* of the order being largely beside the point (other than the degree of difficulty involved for the subject according to the strength of the tendency to be overcome, a factor which redounds to the polarization of the “bidder”). We find further that any *failure* to exact conformance in “bidding” results in

a proportional *loss* of negative polarity to the aggressor, a situation which the entity must then attempt to rectify. In this way we see that, in terms of the higher densities not only are “thoughts things”, but the metaphorical relations characterizing the order as which beings functionally interact possess distinct energy values, and have a direct bearing on degree and intensity of polarization-alignment. To possess a legion of “servants” in these subtle regions is an actual nourishment to the centers and systems, a kind of psychic “food-chain pyramid”.

At this point a pure bolt of recognition should allay any further doubts, either of the type which question the factuality of **Strieber’s** accounts or the kind that equivocate as to the actual nature of the entities involved; for we find the **Strieber** entity virtually paraphrasing the earlier **Ra** recitation re the modus operandi that identifies the Negative polarity, in its suggestion that the failure to exact obedience on the part of the imagined “Crusader” bears punishable consequence. Not only is this “narration” of the visualized scene an adequate admission of the terms involved, for those with prior knowledge as is supplied by the **Ra** description; it is a continuing *illustration* of the way in which the Negative polarity extorts the desired obedience—and thus soul capture—through manipulation of the Love value belonging impartially to the psychic plane through which this largely takes place.

What then are we to “do” with the counsel of the general Teaching thus far delivered to this density, such as that of “love thine enemy?” How are we to interpret such a precept or indeed understand the principle of Love altogether, when its application seems so susceptible to a sticky, spider web ambush from planes of reality actually *eager with invitation* for so innocent an approach?

Love Was All He Said

At this point it’s important to understand the way in which a spiritual truth is necessarily *reflected* into zones of adaptation. Principles applicable to one density of consciousness aren’t just outmoded and put aside upon “stepping up” to another density. It may however be necessary to identify the form in which such a principle is recast, according to requirements of a density nearer in direct spirit to the Truth which it expresses. In this sense, from a perspective that may be characterized as “4th density”, the appropriate disposition of the Love-nature which serves it most perfectly on all occasions is that of *whole-hearted Love of the “One Infinite Creator”*.

We may of course readily recognize this “higher truth”; it is none other than the Shema of Israel, which Jesus identified with the heart of the Law. If then the first spiritual precept to “Love God with all your heart” is a familiar reference of *3rd density consciousness*, how is it that such a framework possesses it? And how does such a reference coexist with corollary commandments and encomiums, i.e. precisely those such as “love thine enemies”, “love your neighbor as yourself”, etc.?

The general rule, “Love God”, reaches alike to every density, for it is in its *essential* character the spontaneous outpouring of the Truth of Life apart from any formulation or customized tailoring. Thus the 3rd density freely receives it, just as any other, regardless the functional state of understanding. At the 3rd-stage level of egoic self-reference, such a rule incarnates through abstract conceptual distortions practically screening direct cognition of that Whole which is the real referent of the rule. In order that such a rule be functionally operative and lived according to its spirit, a level of mind-body integration and harmony is required that abuts the threshold integrity of a “4th density”; for such a (minimal) state of unitive coherence is able to surpass *identified allegiance* to the ego-divisive verbal mind, thereby settling into congruence with the actual holism that informs it as reflective expression of the Holism of the Creator.

It is through such holistic grasp that the undivided Love of the Creator is received as the constitutor of all centrist reference, so that such a composed self-center may in full awareness ascribe that Love-value to its true Giver, faithfully returning the Gift. Where—as

in the ordinary state of 3rd-density consciousness—this cannot be done directly owing to the prohibitively *low level* of mind-body integration and harmony, Compassion-incarnate adjusts the means to suit the available material. Thus a relatively indirect instruction is necessarily given, one which compassionately takes into consideration the actual compass of comprehension practically available.

The “holism” of Self and Creator is functionally masked at 3rd density level by the compulsive allegiance of the (potential) whole-value of identity in one-to-one *equations of identification* with the preferential profile of the ego-inventory; thus the advice to “love thine enemy” may be understood as very practical strategy meant to extend the I.D. beyond its contractile, lopsided self-enclosure into a more *unified resolution* recognizably encompassing polar terms as facets of a single Being. It’s suited strictly to a level of functioning which is not able to proceed directly *from* a grasp of the Whole, but must attempt to *approach* the Whole through comparative inference.

Such a compromise adaptation of the primary rule, while it may serve well enough at its level as a rehearsal, shows precisely why it was a stop-gap measure progressively less viable *in very practical ways* as consciousness approaches the plane at which the Law operates through self-evident values and direct qualities.

When the general level is raised at which the Love-teaching is received, the relative inefficiency of its previous level of reception becomes apparent; the possible pitfalls and mental snares of that reflected, stepped-down viewpoint emerge like serpents and spiders from the rocks when the open invitation to take on the higher responsibility of a more profound level of existence at the same time discloses conditions revealing the defect of lesser adaptations, and making mortal the dangers of persisting to identify a whole and indivisible Value with fragmentary phases or preferred parts.

When (in adaptation to the more direct Influence of Truth infusing the higher densities) we learn the whole-being expression of Love as that spontaneous *Love of the One Infinite Creator*, the very essence of Love tends to emanate impersonally *as a global value*, spreading without effort or special address to all quarters where it’s received or not according to the specific will of every form. In this way its Presence doesn’t become confused with the conditional presence of the myriad beings “positive” or “negative”. Nor does its Presence become confounded with the mechanics of “give and take”, which are all relative identifications of the mind (look again at what befalls *Strieber* in his mental efforts to *specify* the love-value he felt lurking in the worst of circumstances; notice the manner—common to the complex of 3rd-stage psychology that accepts the teaching of Love according to its lights—in which he winds the skein of complicated love-strands through a conceptual miasma of “owes” and “oughts”, bewildered by just those ordinary terms of psychic bookkeeping).

The Portrait of Dorian’s Grays

When considering the extraordinary deception woven about the circumstances of such abductions as *Strieber’s*, we may wonder how it is that the entities involved don’t simply use their obvious powers of illusion to mask their awful character; for in all the captious play-of-mirrors produced in relation to the principle of love, the actual ferocity and venomous character of the Crusaders seems to

spring irrepressibly forward, thus in a sense almost *requiring* a tremendous expenditure of energy and time toward bullying some interpretation that belies the painfully obvious. The answer to this, also shows succinctly the real nature of the phenomenon with which we are dealing.

The origin and informing character of these entities is, self-evidently, that of the density corresponding to (what esotericism knows as) the *astral* plane; and what esotericism knows of the astral plane clearly accounts for the *transparency* of their basic presentation, which, as we’ve noted, calls for an overlay of psychic subterfuge. The Law governing astral existence, requires the exteriorization of basic character in identifiable symbolic terms. All “form” in its astral origin wears its heart symbolically on its sleeve. It is for this reason that a physical object of apparently neutral character such as a knife, when perceived astrally may distort in dream-fashion into a recognizably malevolent entity, assuming a distinct persona in the manner of anthropomorphized objects in a Silly Symphony.

The *Strieber* entities give the overpowering impression of malignancy, because that is their character; and by extending their essentially psychic, 4th-density being into physically perceptible



range, they are merely spreading the compulsive “honesty” of the self-symbolizing Astral medium into twilight structures visible to eyes of flesh. (Such spontaneous, symbolic exteriorization functioning much like the Portrait of Dorian Gray, becomes progressively less reliable as an index of “moral valuation” the higher up the scale of densities we ascend; thus the luminous, angelic white entity *Strieber* encounters as a kind of harbinger of death in *Transformation* does not qualify by appearance as a positive manifestation. It is of the Negative along with all the others; but it is a relatively rare presence in the corpus of the *Strieber* account, since it emanates from the *5th* density of creative Mind. Thus it represents in its appearance the power to conceive and govern whole patterns of exteriorization. The *Ra* material discusses just this capacity of the 5th density Nega-

tive adepts to assume so fair a shape; and in fact the likelihood is altogether greater that higher-density entities either positive or negative who manifest in more “pleasing” human terms are *5th density* beings able to modulate the matter of visible appearance according to inner conceptual requirements, rather than merely being able to regulate it from a point past its primary patterning and projection).

Speaking With Forked Tongue

It is for this reason of direct symbolic disclosure that the Negative hierarchy often finds more efficient means of dissimulation in the *channeling* phenomenon; for here, there is no direct encounter or condensation to “visible appearance”, but only the medium of the *word* to be interpreted according to the recipient’s lights. The mode of expression is by that measure *indirect* and the Negative beings have therefore a greater latitude of deception at their disposal.

Since the Negative is altogether, in one sense, an inverse reflection of the Positive or True Creative Logos, a parallel configuration borrowing all its components by simple reversal and distortion, it proceeds by the method of imitation. It *apes* the expression of the positive, the more meticulously where it wishes to be mistaken al-

together for the positive so as to subvert the message for those who tend to abide by it. Its typical strategy is to adhere so closely to the letter of the positive as to be virtually indistinguishable to all but initiated awareness, installing itself through the rhythmic lull of entrainment so as to catch the "congregation" totally off guard when it diverges slightly or greatly from pattern and so pulls a portion of the positive track along with it.

The voice of the Negative is of course the more ingratiatingly imitative where the inclination of the recipient is already to the positive; a negative receptacle requires no such precaution.

Even in the case of channeling, however, the character of the Astral origin compels the insinuation of a sign, a kind of confessional signature no matter how subtle. Indeed this trait of the communication is often accepted as a device of mockery suited to the character of the source; it is played with as a defiant means of asserting the true identity of the Signal, hiding it in plain symbolic sight in conformance with "astral" requirements.

This law which insists even the physical form exhibit "some sign or characteristic which identifies" the "true essence", is indeed remarked upon by one such channeled source, the *Hilarion Material*. *Hilarion* is an entity identified in both the "Christ" materials of V. Essene and the Ra channelings, as a being of the positive Hierarchy. Thus when we see books on the shelf bearing the *Hilarion* moniker we automatically respond with a beam of recognition. *Hilarion's* "channel" (Maurice B. Cooke) seems decisively predisposed to the Christian stream of positive teaching, so we are not particularly surprised when the second half of *The Nature of Reality* (which had up to then been a so-so account of "esoteric physics") breaks into a frenzied description of the imminent apocalypse. Indeed, the book ends with a graphic account of destruction and the final torment of souls as they are beaten to their knees in extortion of a "repentance" and "turning to God" which they'd apparently been reluctant to make even when melting into one another.

This stomach-churning peroration was no accident, for in another *Hilarion* volume, the source proclaims that the structure of the book had been deliberately designed with the "Armageddon" last so as to attract a particular type of "select" readership.

My, What Big Eyes You Have...

With an eye, then, to the Ra account re the way in which the Orions have traditionally sought to subvert the positive messages and meanings of persons or events through emphasizing moods of doom and destruction, making such negativity a *central feature* of the communication thus deflecting attention into brooding byways of despair, we may turn to the *Hilarion* account of the existence of Negative Beings (or the Dark Brotherhood, in the terms of this source). According to *Hilarion's* account, the Negative is allowed to exist because its minions act in the ultimately helpful and healthy capacity of predators that only decimate the "diseased" ranks, i.e. like wolf attacking the sick or congenitally weak specimens of caribou (*Hilarion's* analogy). "The wolf attacks these defective caribou, and would never think of wasting its energy trying to chase or bring down healthy specimens. By weeding out the weaker ones, the wolf ensures that the healthy remains strong." With this edifying version of Christian Darwinism, we are comforted into the notion of our constitutional safety (considering the readership of such a work to be ipso facto amongst the Elect, an assurance "we" were already given in the gross-out discussion of Armageddon).

This encouraging information hardly tallies with the outright attack which the Orions launch upon the Ra channelers in the very midst of their activity (see books II, III and IV, *The Law of One*); nor does it square well with what initiated knowledge otherwise knows about the effort of the Negative to attack, discredit or physically eliminate those who are quite positively polarized and in no way "defective" in the arrogant sense that the *Hilarion* material proposes. It is also more than passing interesting to note that in the film

Wolfen taken from *Whitley Strieber's* book of the same name, the behavior of the predatory creatures is rationalized in *precisely the same way*, i.e. that they are simply weeding out the recrement of mankind thereby ultimately strengthening the total stock (the fact that one of the "good guys" who even *subscribes* to this interpretation and is in no way depicted as "defective", is nonetheless wantonly massacred by the creatures, attests to *Strieber's* early powers of schizophrenic dissociation, and gives us as well certain cause to look more deeply into the character of the *Hilarion* idea).

Too Many Plots Spoil the Cooke

When we read on that the Dark Brothers are allowed to "test" a channel such as Cooke (apparently alluding to an early channeling incident that must have been a source of some distress) by making an *agreement of exchange* with the "White Brotherhood", each bargaining some "deal" or concession from the other, we are squarely on Donald Trump territory and about as far away from the facts of the polarities and the densities as we can possibly be. (The "*Hilarion*" rationalization here is almost self-evidently a cover story, meant to assuage Cooke more than anything else; for initiated understanding *does* recognize that a Negative source, having attached to a positively-disposed channel, will push the negative hypothesis into increasingly more overt expressions in order to determine how much the malleability of the subject will yield to directly negative propaganda. Apparently at one point Cooke must have been pushed too far, and this absurd scenario was manufactured to explain the cordially adversarial relations whereby the Positive and Negative players of the higher realms use the channeler's "inner instrument" like a Borderland parimutuel window).

When we read further along how to identify the interference of the "Dark Brotherhood", we presently realize we are being disabused of the *Seth* teaching (although of course that teaching isn't specifically named due to the punctilious observation of that "Cosmic Law governing the operation of these testing factors"); *Hilarion's* objection, revealingly enough, has to do with the "impropriety" of explaining *cosmic* truths of simultaneity and probability to the anthill focus of physical consciousness, which should be properly stuck with the *mea culpa* considerations of karmic consequences; thus "*Hilarion*" neatly pivots us *back* into proper alignment with all those conventions of cultural conditioning that chronically lock us in place as a mechanical unit of cause and effect, and away from the elastic efficacy of the *present* poised at the juncture of potential change.

Finally, *Hilarion* regales us with the assurance that all "galactic observers" within the "region of Earth" are necessarily friendly, contrary to the misleading teachings which would have us believe otherwise. "There is the suggestion that some are distinctly alien and even hostile, and that certain of these beings kidnap humans and kill animal life for experimental purposes". To disabuse us of this baseless notion, "*Hilarion*" resorts to no less than the old canard about the inability of any civilization in the galaxy to develop interstellar technology until such time as it decisively overcomes all negative inclination (!). Thus any close encounters, sightings, landings or interactions of a third or fourth kind are necessarily conducted only with the kindest and most positive of beings.

Flying With Expired License

It is precisely here that those most glaring of contradictions indicative of the channeling phenomenon become inflamed, and virtually *force* themselves upon our notice...right along with a virtually self-disclosing hypothesis that accounts for them. For the Ra material *specifically* warns that Confederation sources (with very few exceptions) refrain from any but long-distance exposures, generally only in order to extend the range of mankind's inquiry toward renewed consideration of the Unknown, and almost never effect that kind of encounter known as "landing". Landing has become the almost exclusive resort of the Orions, the Negative Beings. Thus, virtually all

"close encounters", reports of abduction etc. are of the manifestly negative type. Despite his composed rationalizations, Strieber's emotional declarations continue to ring in our ears; and the material gathered into such sources as those of **Budd Hopkins**, certainly have little of the aura of "good will" about them.

Then just what could this "counsel" of the **Hilarion** material possibly mean? It seems only too evident from this as well as other "revelations" of the teaching, that the "**Hilarion**" source conforms to the methodology of the Crusaders as disclosed in the **Ra Material**, i.e. that of close adherence to the style, thought and content of positive sources so as to sneak in "undercover" as it were, and at the point of greatest vulnerability—when the subject is set at his ease and off guard—pour the venom of disinformation in the audio channel. (We should be interested to know that "false teachers" can be identified by their appearance, whether they're too fat or too thin, whether they look as if they can be trusted and—oh yes, whether they've "ever been hounded through the courts, or banned from any country"—an interesting criterion, considering such an ostensibly "Christian" source. Perhaps the governmental persecution of true Teachers is a phenomenon confined to the old Roman past.)

Taking all this together, we may now identify the very emphasized oratory of the **Hilarion** material on page 26 of **Dark Robes, Dark Brothers**: "Specifically, by asserting that one should *love one's enemies*, Christ presented the single most effective way to overcome the temptations of Earth life and to confound the whisperings of the Dark Brotherhood." Interesting that of all the possible teachings and enlightening words of the Christ, this material should go out of its way to emphasize the *one* expression which is most subject, in such a context, to the distortions of 3rd density thinking patterns. For of all the possible teachings that might effectively have been drawn upon, the one which lends itself most readily to the snares of the Negative poachers is precisely this precept, presumed by a mind-body complex insufficiently unified in congruence with the conscious axis to make the necessary 4th-density transference from the psychological structure where such imperatives come to lodge, to direct alignment with the unitive Ground of Being from which love streams naturally in all directions without entrapping concern for "friend or foe".

I'm Sorry...Do You Have Any Credit Cards?

Finally, there was the case of a student of the initiated teaching who, finding the cover signature on the **Hilarion** books quite intriguing by virtue of its consistent entwining of the heels of the letters "L" and "A", decided to apply a Qabala of numbers whereby, lo-and-behold he determined that the deliberately emphasized letters clearly spelt "LA" which in Hebrew means "nothing" or "zero". Since Zero is alphabetically an "O", his eyes automatically transposed that letter over the "LA" on the cover signature and, much to his amazement, one of those clever "astral" disclosures sprang forward, of the type that shows the natural compulsion of the medium to reveal its character symbolically (as well as the perverse delight taken by the Negative in coding its identity in plain sight): HI ORION. (Some of the book covers indeed *expressly separate* the letters H and I from the rest, which are arranged to touch one another so as to group the "LARION" with its entwined L and A in one bundle). Indeed the contents of "**Dark Robes**" etc. (a book, remember, *about* the negative beings) pointed to its own clue in declaring that even all physical things bore the symbolic signature of their particular source.

This Is Not the Behavior Of an Ordinary Kitchen Appliance

It is necessary to note that the growing public presence of "negative" literature (i.e. books overtly or unknowingly inspired from spiritually-negative sources) is not just the mild circumstance of a "democratic distribution" of diverse information. The presence of such material is not innocuous; nor is its active component confined to the personal imbibition of content. It is not in the contents *alone*

that such media carry their infectious messages. Everyone reading this review section should take to heart the real lesson contained in the incident reported by Strieber in **Transformation**, i.e. that of the psychiatrist who upon *seeing the cover of the book* felt compelled without knowing its contents to purchase it, the next day being greatly surprised to hear a number of *patients* report dreams of UFO abductions for the very first time. It is revealing that the covers of both Strieber's books depict the alien countenance of his abductor; for in **Communion** we learn that the entity actually *modeled* for Strieber at the interior space of his "third eye", specifying that it wanted the artist who would transcribe the description to *get it right*.

To initiated understanding this clearly shows that the accurately-rendered image was to be used as a kind of talisman, or a material basis for the manifestation of that force-influence to which it corresponded.

Strieber gives vent once or twice in **Transformation** to the sentiment that, if he really thought the creatures with which he was dealing were negative or harmful he could not in all conscience expose people to what was clearly a powerful and unpredictably commanding influence. He should have held on to that thought. He should have made every effort to penetrate the shallow rationalization by which he "forgives himself" for his recalled participation, in youth, as the apparent ringleader of the "children's circle" whose job it apparently was to lure acquaintances out into the haunted woods of night where presently, amidst the horrified shrieks of many, they would find themselves face to face with something unspeakable. . .

In addition to Strieber's books, there is a motion picture of **Communion** soon to be released, as well as a spate of other movies already primed for the competition that purport to depict true-life alien encounters. These should not be considered ordinary modes of entertainment. They must be understood as vehicles, very potent types of imagistic "talisman" supplying the material basis for a mass manifestation of unprecedented character. We need to listen more closely than ever now, to a channeled source that dates back to 1957; for in **The Secret of the Andes** we find a corroboration of the **Ra** source which predates that communication by many years, in which it is specified by name that we are under invasion by the Orion Empire.

It is necessary to understand this for what it is, and not treat it as a removed spectator witnessing another phenomenon of mass entertainment. Everyone is involved; and there are children present. As was indicated, in last month's review titled **Movie and Dream; the Qabalah of Star Wars**, motion pictures have a profound correspondence with and influence upon the dream-psyche, owing to the structure of the medium. That harbinger of the "Freddie" films, in which there arises an incursion into waking consciousness of the terrible content of dream and nightmare such that they are presently confounded and inextricably entwined, is poised to take place "in reality" the same as it was prefigured on film. In the specific instance of the Strieber books it is very advisable to neither buy nor read them, and this is *not* the expression of some "censorship of content". There is something else going on altogether, something for which the public, in its wildest dreams, is scarcely prepared. It is advisable that the new films such as Strieber's dealing with UFO abduction etc. be given a wide berth, and certainly children should be kept away from them. They are not just "spooky" movies, good for Halloween-type thrills.

This is not an easy month for your reviewer. The decision to advance this discussion and extend such difficult, goblin-ridden counsel has not been made lightly. But the truth should at least be put out, out on the bookstall floor or streetcorner along with every other conceivable kind of information in the endless bid for the ephemeral attention of this place. What people choose to do with it, is a whole other column.

But do it we must, and did. This is the ghostbusters boys; your cover is blown and your time's at hand.

E.T., go home.

Ra Material (collected works)..... *****
Seth Material (collected works)..... *****
Communion and Transformation..... Z

(This is an instance in which a Z recipient actually exhibits emotional and intellectual power, and even occasional sparks of real Gong Fu. Strieber is an excellent writer; but these books have the beauty of the molecular structure making up the substance of strychnine.)

Hilarion Material (collected works)..... Z

Don't miss Part Three of *Channeling, UFOs and the Positive/Negative Realms Beyond This World* in our November issue. (Oh, yeah, did you hear the one about the UFO that crashed in New Mexico in '47 that the military recovered.....)

Rating system for all book, film, tape and video reviews:

Has Gong Fu; has technical and intellectual/emotional power.

Has Gong Fu; has a measure of both technical and intellectual/emotional power.

May or may not have Gong Fu; has a measure of technical and intellectual/emotional power. (Since Gong Fu is the principle that sets a work on fire, intensifies it to the degree of boiling, then a 3 or 3 1/2 that has Gong Fu possesses It to the extent that the work, at least in part, exhibits first signs of real kindling; it strikes a genuine spark of combustion, at least in places. If a 3 has no real Gong Fu, it must still have a good degree of technical, intellectual/emotional power.)

**

Has no Gong Fu; may have technical or intellectual/emotional magnitude.

*

Has no Gong Fu; has little, though possibly some, technical or intellectual/emotional magnitude.

Z

May have any of the above, including (sometimes but not often) Gong Fu, but still deserves to have the Marx of Zeppo swiftly etched across the designer label of the smug-fitting back pocket.

PART THREE

Will, Being and Well-Being

In Parts I and II of *Channeling, UFOs And The Positive/Negative Realms Beyond This World*, we discovered through such proffered channeling sources as the *Ra* material that "graduation" beyond this threshold 3rd-density existence holds ambivalent implication, of a disconcerting type, for many who'd assumed that only the "positive" alignment possessed a purchase on integration adequate to make the advance in required spiritual coherence. As it turns out, negative orientation of a virtually exclusive, self-serving type is capable of commanding a coherence and sufficient systemic integration to "make the grade" as well; as far as the necessary technical degree of mind-body organization and threshold intensity (or purposive unity) is concerned, the negative polarization can exhibit a "harvestability" equivalent to that of the positive.

This is where the comparison ends, of course, since beyond this admixed 3rd density plane (where such decisive polarization is still being determined) the astrally inclusive, biopsychic fields of an overt void-nature obediently factor out into discrete realms of qualitative organization spun respectively about the poles of either positive or negative orientation. In this way the *law* of that level is exhibited whereby correlated properties formally combine into the unific presentation—or cohesive exteriorization—of the Symbolic value functioning as common denominator. Thus *identities*, on the aggregate, compose worlds of a basically astral character; and even the "materializing" property of the informing, focal-coordinate lockin whereby that group psyche incarnates exists structurally as a system of mutually reinforcing parallelisms, of a uniform or consistent grain, as distinguished from the earth/physical structures integrated through magnetic opposites.

The idea that negativity or "evil" orientation not only survives this plane of blindered ignorance but is capable of holding its own and advancing through the higher spheres of more overtly spiritualized substance, is not only a distressing notion to many; it is difficult for some to accept on philosophical grounds due to the conventional understanding that "negativity" is inherently self-divisive and therefore ultimately *disintegrative*, so that the requisite unity consistent with Being through the higher planes is by nature beyond its grasp.

And of course this "understanding" holds, in an ultimate sense; as the *Ra material* explains, spiritual advance through the Negative Hierarchy reaches the pons asinorum at the mid-point of the 6th density, the cutting-off place just before consciousness merges into unity with the so-called Oversoul or Higher Self. Anywhere prior to that point the inherent deficiency with respect to negative orientation may have become apparent to the ongoing focus of consciousness assaying an "ascent" by that mode; the upper limit of friction, division and thus *inanition* (or unassimilable energy) may have been grasped as the inbuilt barrier to perfect resolution with the Whole in terms of the Negative tactic.

But in any case such recognition is inescapable at the threshold of mid-6th density, where the necessary magnitude of Wisdom as it is made impartially available discloses the structural impasse automatically defining the upper limit of compatibility between the "unity" of negative orientation secreted around the false granule of the illusory ego-self, and the uncompromising Unity of Absolute to which that imitative parallelism aspires.

It's important to note however that such inescapable concession, *structurally* imposed at the degree of conscious intensity corresponding to "mid-6th", indeed occurs at a relatively "late" or advanced point. This indicates that the stress of *ultimate* incompatibility is not a sufficiently imposing factor through any of the

previous stages as to comprise an Imperative. There's no *obligation* to confront its proposition until the brink of Oversoul consciousness is met. Thus the whole hierarchy of spiritual strata preceding this point, is capable of being strewn with the litter of relative negative "waste" without obligation on the part of that poisonous processing to dissolve.

When we turn, puzzled, to ask how this may be, we need look no further than our own 3rd density backyard. Here recent research has found, on behalf of the general *Newsweek*-consciousness, a medical evidence not only tending to substantiate aspects of the perennial Teaching regarding the relation of mind and body, but ripe with other implication. Scientific investigation into the "mental" influence on health now documents that those exhibiting strong positive correlation with values of will, confidence and self-motivation tend to display proportionately strengthened immunological response. Just as it has been established for some time that protracted stress of an internalized type (manifesting as "anxiety") as well as prolonged periods of grief, depression and boredom predictably correlate with depressed immunological function, so conversely it's been found that the highly purposive, self-confident psyche literally tends to amplify the available leukocytes and in general enjoys a more resilient mind-body vehicle—and this *independent* of whether the personality is altruistically oriented, a self-giving soul of beneficent motivation or on the contrary a narcissistic and manipulative power-broker out in full-force service to *self*!

This should be very instructive, for those who can read the implication. From this interesting data, we can locate the *mechanism* behind the otherwise perplexing intelligence that beings of a committed, threshold degree of inner unification whether positively or negatively oriented may equally advance to the higher ground, where their respective intentions are granted more potent substance with which to experiment.

The common key of such advance is not the *character* of the motivation per se; it is not a *moral judgment* that draws the line, at any threshold gate of progress. The common key is identifiable here as *will*, and its closely correlated value *confidence*.

Will is medically associated with the cerebrospinal system, known as the *volitional axis*; voluntary behaviors and conscious determinations are connected to lobes and circuits of this central nervous network. A highly integrated and purposive will would in effect "take command" of the whole being much more thoroughly, as that channel through which consciousness acts and with which it's aligned comprises the locus of organization for the total mind-body complex. Through volitional unity all instruments, faculties and functions of the being (*processed* by autonomic currents of the subconscious systems associated with the extended line, or frontal axis, flowering with its glandular "points" from the central column) tend to be harmonized, set to mutually cooperative service in a more efficient manner than is characteristic of the average of those same processes taking their "commands" from self-contradictory programs, of mental quandary or mutually conflicting intents, indicative of the ordinary 3rd stage psyche adrift in the chop of indirection.

It's axiomatic that those functioning through a sense of "control", whether control over some precious little area of their private world or apparent control over the fate of nations, infuse a kind of concord through all the coordinate processes of the mind-body whole; such agreement of intent amongst contributing aspects of the being promotes a high harmonization of part to subconscious part expediting the efficient issue of every order.

Conversely, those with a comparative sense of helplessness, of lacking control or the capacity for direction and who therefore succumb more readily to despair, equally "program" the subconscious processes through volitional currents and intents; there is no escaping the order of influence which always, in will-positive manner, proceeds from the implicit "command" contained in the aggregate of intimately-held concepts and feelings, of which the relative congruence or lack

UNWANTED:

The Great Orion Gang (GOG)

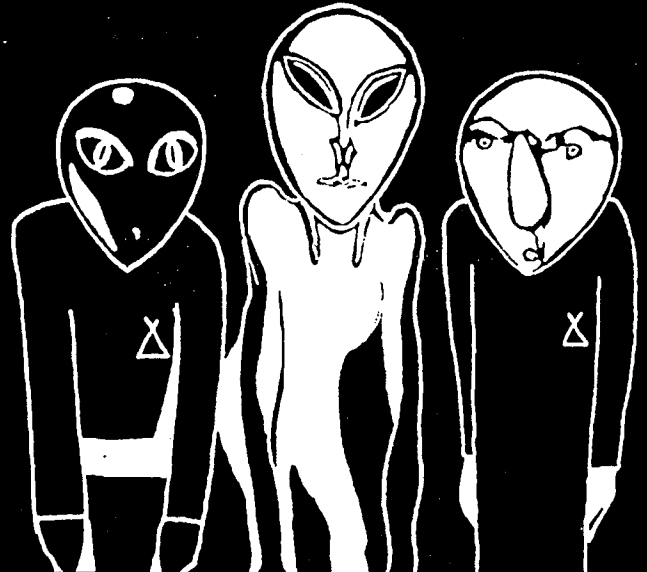

Sought by Law Enforcement Officials in all known Galaxies. On 6 counts of violating the Man Act; 66 counts of infringement of Civil Liberties; 333 counts of Psychic Burglary and Aggravated Mayhem. The Sloe-eyed Vixen in the center is their reported leader. If you see these notorious cosmic banditos, do not attempt to subdue as they are armed and dangerous...Call FBI (Free Being Intelligence) for immediate Protection.

of correspondence with inherent Unity impartially authorizes the behavior of subconscious response-patterns in faithful transcription of the character of the command.

In this framework there are really only two kinds of mental contents and feelings with which the value of identity can become involved, i.e. those which reflect and enforce the reality of the volitional directive of the mind-body whole, or those which belie it. In either case the subconscious systems process the mind-body pattern and its *em* field in conformance to the internal implication of the identity-content. Thus it's never a matter of whether there exists some impartial gauge of being from which a "realistic" assessment can be made regarding the actual proportion of our "control" or "helplessness" as subjective centers of the universe, or objective bits of flotsam in the buffeting cosmic tides; there is only the *impact* which such estimates, infused with the committed force of identity and "volitional subscription", may make in their respective values on the nervous systems that encode their implications in the cells and biochemical functions of the mind-body vehicle.

Since there is only *one* orientation (between these two possible positions) which conformably reflects the *unitive truth* of the very process of which it's a function, there is only one orientation which can effectively serve to advance the being into deeper congruence with the ground of that truth; for the opposite orientation *denies* the

validity of its function in the very process of implementing it (as an inevitability of the structural correlation between the mind-body system and Whole-conscious Being) thereby *undermining* the inner instrument of its potential self-focus and adjustive resolution. Ergo, either positively-oriented or negatively-oriented beings of a sufficient, threshold value of volitional unity are candidate for advance to the "4th stage" in the developmental saga of consciousness. As far as the practical mechanics are concerned, it's equally possible to create a strong integral system in orientation about the axis of an insight inspired by the spiritual Oneness of being, or around the illusory core of a persistent self-hypothesis to which the credit of Oneness is extended.

This brings us, in turn, face to face once more with a problem we'd commonly assumed was surpassed once we'd crossed to the comparatively "foolproof" ground of *channeling*.

Crossing the Channel

Channeling, after all, seemed to possess a timely-inbuilt solvent to a difficulty just recently experienced, i.e. the troubles encountered when in our dawning ecumenicalism we'd presumed the Eastern attitude and opened ourselves to the possibility of *embodied* enlightenment (therefore necessarily exemplified in some current, incarnate being Who could act as the exhibition and demonstrable forerunner of our own imminent awakening). What was rapidly discovered, (as a genuine or apparent disclosure in any particular instance) was that whoever *declared* himself enlightened was not by the sheer magnitude of such announcement necessarily or automatically enlightened.

This of course led to corrosive distrust regarding the possible, lurking presence of *ego* behind any agent occupying the same (notoriously ego-riddled) plane as ourself.

Embodied, walking-talking Enlightenment was a novelty devoutly to be wished by those whose cultural instruction confined the benefits of spirituality to an afterlife, and to one historical personage possessing exclusive proprietary rights to the genre; but the barrier to locating the living address of such a sublime state of consciousness seemed proportionately insurmountable, since the very factor making it so attractive (i.e. the possibility such a Freedom could arise precisely in the heart of ego-territory) was also the factor making its identification *through* that agency and *in* that milieu terminally ambiguous.

It's for this reason that the phenomenon of channeling, young and marginal in the '70s heyday of Esalen, human-potentials, est and Divine Light Mission inevitably flowered as that first hope waned.

The prospect of channeling seemed suddenly made to order. If the Catch-22 of locating Enlightenment-incarnate in "3rd density" hinged on the common presence of ego belonging to so low a plane (permitting sheer chicanery to cloud perception) then the obvious answer was to inquire after that Enlightened status only through planes or states of being intrinsically *ego free*, and thus patently safe—by definition—from the subterfuge of self-serving. The presumption underlying this, of course, took background from our very cultural conditioning through which we'd long learned to make the conventional equation between "spiritual" existence and innate beneficence. Naturally we were more than delighted when (ignoring our own new, highly-touted occult discovery re "like attracting like") we began apparently receiving "objective" corroboration of this equation from our contacts with the Other Side.

For yes indeed, Seth Spoke and many more followed suit to the effect that "negativity" is a subjective misperception, brought about by the masking opacities of our 3rd density camouflage world and therefore—like a deepsea fish—unable to survive the transition to the "upper atmospheres". Ignore for a moment that Seth actually qualified what was otherwise a very emphatic and consistent teaching about the formative power of thought, in a minute passage from *Unknown Reality* in which he proclaimed that "90% of the time",

encounters with the specter of negativity are purely self-created. Ignore the fact that the exception of even one all-but-negligible percentage point changes the picture dramatically from the wholesale authorship otherwise espoused—ignore all that but for the *larger issue* as to how it is that Voices speak to us from an apparently Homogenous Beyond, in tones of supreme confidence allowing no room for reservation and still manage to contradict each other as flatly as spokesmen of competing political parties? How is it, we may well ask, that one Voice lulls us with the glamor of a world in which all "evil" is reduced to a subjective ignorance that can't withstand the all-absorptive Good composing the inner planes; and another is equally sanguine that the Negative comprises a whole Ontological Orientation, a basically *spiritual* interpretation of Being existing independent of the projection-screens of our privately enveloping auric wall, vouchsafed validity as a polarized *universe* of implication extending a particular hypothesis of "unity" to its logical extreme?

And how may we, in our apparently inferior position, possibly discriminate between the two?

The usual new-age afflatus to the effect that both may be "equally valid in their own space", just doesn't sit well. It's for this very reason that we turn again to the *Ra material*, as per our method of last month in which we "play by Queensberry rules" and consult the *internal evidence* at its highest available source in order to find some resolving principle.

In this case, it's necessary to note the distinction which Ra makes between the orders of *space/time* and of *time/space* (all the densities from Ra's Perspective downward are organized in these complementary ways). Although the *Ra material* doesn't detail the significance of these organizations beyond certain preliminary points, they are cited as categories of consideration because of what they necessarily imply.

Through the Looking Glass: The Time/Space of Our Space/Time

We may understand "space/time", first of all, in the terms we're familiar with. We occupy the system of our space/time as a vehicle, (or axial, mind-body locus) through which the coordinates of that system necessarily arrange all features according to the requirements of *situationality*. We are *located*, vehicularly, at and *as* a particular juncture of time and space, so that the values of "near" and "far" acquire functional importance. In this context, our limitations are our opportunities; what is filtered through the bottleneck of space/time becomes the focus of our concern, and the material of our resourcefulness in operating through finitizing faculties. Because our condition is one of centrist perspective and therefore discriminative *navigation*, the order of space/time comprises the context in which progress is possible through situational *doing*. We learn by acting through defining conditions, from which an order of consequence develops whereby to gauge all *Adjustment*.

We may have heard that at death, the limits of the localized body dissolve, and we move through a lighter material into conjunction with a display of space and time that's comparatively plastic. It's here that, in the unity of a presiding Light, we may review all the features belonging to our personal past without regard for the usual measure of sequence, or apportionment of priorities. Everything appears equally available, in the manner of a deck of cards fanned out in panoramic display or as simultaneous images shining in a reflective flotilla of bubbles. Here there is no "rootedness" at an enclosing, defining space/time juncture similar to that which was experienced in physical life. The "vehicle" (or axial locus) of the mind-body being which may be identified as operating in the new state, gives no impression of imploding on a contained self-sense but rather has more the feeling of an acceleration constantly surpassing itself, expanding through Space of starry nerve-clusters in a range embracing the soul-record to the finest part of the life last lived. This is the complementary field of *time/space* belonging to the *inner planes*

of 3rd density existence. The ticks of time are indeed *spatially* exhibited, in a kind of interior hall-of-records where a life-review may be conducted and all the "masked" elements unveiled for a kind of global consideration.

This is an *interval* in the pattern of soul-progression, usually conducted as a kind of protracted sleep-and-dreamstate wherein experience may be assimilated, distilled, and the various steps of "dissociation" rehearsed whereby the heart is ferried—on the implacable subconscious current—through the underworld ordeal of a purifying *dis-identification* from every attachment and lingering fixation of form—summing in the Amenta of the psyche's recuperative rest what must eventually take place as a *volitional work of conscious understanding* in the context of space/time limit.

This *time/space* framework of the inner planes is inferentially sealed up, self-enclosed for purposes of such soul-examination; for here the most important determinations must be made as to what the soul *has within it*, and this process necessarily goes on without disturbance.

Such a state is a kind of clearinghouse for the assignation of souls, each according to the quality distilled in the process of "becoming" the sum-total of what, viewed in the complementary space/time frame, is spread out piecemeal as a sequentially shifting pattern. From this time/space antechamber, where the soul aligns progressively with the *non-local* character of the compositional coordinates subtending all "local" clusters of physical existence, the distillate of psychic focus comprising the latent personality-expression may be transferred to the *space/time* framework most consistent with its net value; these worlds of space/time organization may indeed, beyond the admixed education of 3rd density, polarize to the emphatically positive or decisively negative.

The complementary time/space frameworks of the "inner planes" of each succeeding density, function very much on the same principle of review, analysis, attunement, adjustment according to sum-volitional inclination, and further assignment of *space/time* fields in which the relative "localization" of vehicularized consciousness furnishes conditions of real, developmental furtherance and learning.

The "division" between the contractile, self-enclosed *space/time* vehicle and its expansive (self-surpassing) *time/space* counterpart seems much more solid and impermeable in the 3rd density framework owing to the general screening-device of that realm, in which the interior order of things is specifically rotated at mutually filtering angles to the physical field of expression. It's for this reason that there's no direct knowledge of or recognition re an "afterlife", for the most part, at the 3rd stage level of consciousness, all such matters being confined to speculation, rumor and culturally modified myth. In the higher densities the "division" between the given space/time and time/space organizations at each level is less severe; there is a *permeability* between the two orders in the higher densities, greater or lesser depending on the refinement of the density.

Each higher density has a *space/time* framework wherein the soul "contractually" aligns with a nest of embodying vehicles, through which the compound focal patterns of specific level-identification produce an incarnating *eversion* of the currents organizing the locus of cross-correlation and perceptual synthesis. This "invagination" of the participating planes of the current-field (through ideoform lockin of the focal-coordinate line) fixes the streams of multidimensional, patterning geometries into a stabilizing structural hold, concentrating a practical station of space/time "points" of coherent convergence so as to formulate a real *position* of true situationality.

The process is much the same throughout the densities. The extreme invagination or turning-inside-out that comprises the physical 3rd-density frame of focus, is represented in familiar terms by the polarized lockin of the *kandalini*, the energy-coils of which seem to settle the multidimensional turns or Moebius twists of the composing current-fields in inverse order of descent around each other; this in

effect nucleates the subtle, radiant-psychic ethers reflecting the given (operative) Typologies so that *mind* and *idea* seem to occupy a position of faint interiority with respect to the fixed "physical" envelope of structural consistency and inertial repetition, into which those psychic coordinates are aligned.

In the condition of 4th density, such incarnative focal lockin formulates a functional specification of time and place in the same general manner, producing a kind of "materialization" of the Astral field into a similar, situational centrism. There exists the same type of vehicular contingency which makes "travel" in the Astral 4th density fields of space/time a matter of actual space "ships" (albeit of the biomechanical type described in last month's issue, consistent with the psychic level at which material is generally organized in such a framework); whereas we are familiar, if only by hearsay, with the flotational mode of conveyance wholly *free* of any mechanical-vehicular requirement in the context of Astral or inner-plane, 3rd density *time/space* frameworks. This accounts for the apparent discrepancy, i.e. the difference between what we hear in terms of the "Robert Monroe" style of inner-plane astral travel conducted strictly in the Soul-vehicle, and those reports of astral-like entities certainly functioning from the plane of a "psychic" milieu that nonetheless require physical-mechanical vehicles of some type to convey them from place to place: the non-mechanical flights of astral transport through unencumbered agency of the Soul-vehicle in general belong to orders of *time/space*, which have a specific and very different function from space/time in *any* given density; conversely, those modes of travel through astral, astral-etheric or etheric-physical fields manifestly requiring a kind of mechanical or "hardware" vehicle, belong to space/time orders of organization.

Either type of vehicle, proceeding from space/time or time/space frameworks, may intrude upon familiar space/time physical reality.

In the higher densities the frameworks of space/time and time/space are equally discrete, since they serve separate purposes; yet the more translucent modes of organization belonging to those densities allow a permeability which makes the fields and informing patterns of time/space more readily accessible to the vehicularized "localism" of incarnative, space/time agency.

Thus to 4th density "embodied" entities, the whole history of a life-system is *akashically* available even though in practical terms they're functioning at a particular cross-section in the span of that history. Similarly, in 5th density the totality of cosmic patterns comprising the infrastructure of all times and places is theoretically available, even though the "incarnative" pattern of the particular space/time agent functions from the perspective of a situational locus immediately responsive to *certain* worlds, space/time frames and patterns.

In every case, the juncture of "meeting" between the Positive and Negative realms and/or the Positive and Negative Beings is generally reserved for the *space/time* frameworks of any given density, since the time/space frames (serving another function) are largely self-sealed as the souls "isolation-tank", where it may take stock—as it were—of the potential moves of further progress through its chosen polarity.

This accounts for *some* of the channeled information we receive to the effect that the Negative is just a chimera, a "projection of our own subconscious fears and primal doubts", etc.; the other sources of such information *are* Negative propaganda, proceeding from the Negative planes themselves.

"Axial" Alliance: The Return of Tokyo Rose

As to the latter, we refer you to the discussion of the so-called *Hilarion* material of *Maurice B. Cooke* in last month's issue. In this particular case the misleading counsel did not proclaim upon the "unreality" of the Negative; instead, it took an alternative tack by recounting the ancient moment of our collective "fall" into material

consciousness as a temptation by negative inner-plane powers which subsequently, so the tale goes, imparted a *spark* of that negativity to the “veiled” soul along with the counterpart spark of goodness furnished from the angelic side. This tale subtly installs a very deceptive and subversive notion; for if there is an increment of truth in the time/space asseverations counseling to the effect that we “create our own reality” (and that as a consequence negativity is but a phantasm of our own mental self-estimates), such truth may be located in the corresponding implication that any term of “negativity” is, necessarily, *wholly self-appropriated*. This is precisely the case, and is the part of such time/space counsel which has a legitimate purchase on the “psychic facts” of our experiential self-patterning.

And it is exactly the personal responsibility, the ultimate soul-accountability contained in this interpretation which the “Hilarion” counsel slyly subverts, through the tactic of conceptually *reifying* the influence of negativity making it in effect a “thing” which is lodged within, an alien presence interiorly importuning over-and-against the volitional consciousness of the soul in which it ostensibly inheres (rather than a *potential*, approached in the freedom of the determining psyche requiring the active appropriation—and introjection—of the consciousness in question in order to possess any personal force at all).

In this way we can see that Negativity is not a phantasm of personal fear and trepidatious projection which “doesn’t actually exist” (an understandable if obliquely skewed counsel from the self-sealed planes of time/space); but rather, we can accept it as a *potential*, as real—in that sense—as any “goodness” or “positivity” (whether as aligned with the ultimate character of things or not) and constituting a Philosophical proposition that springs internally from certain considerations of the general terms of existence. It is not an “independent entity” or alien presence that, like an ensouled parasite, whispers subversively from within (implying a passive, dependent and thus ultimately estranged and helpless relation to it), but a general Proposition *requiring an interpretive orientation* (always ultimately made through the inherent freedom of the determining void-psyche of the soul).

Two tricks of the dedicatedly Negative are (1) to appropriate the short-sighted counsel of 3rd density time/space (or the revivifying afterlife of this dimension) in “confirmation” of the non-existence of the Negative except as a subconscious tendency; and (2) to endow the idea of the negative (as in the Hilarion recitation of the “fall”) with an alien and antithetical formalism that, in essence, imposes upon us a “forced” or inoculated kinship rendering us all that much more powerless and *ineffectual* in relation to its invasive presence. (The fact that in this account we are also “inoculated” with the Good, only makes that value-potential an equally alien and invasive presence contending for the soul in virtual independence of its passive-battleground condition. The soul, in such a case, simply becomes an incidental “site”, and is reduced to the stature of host-organ.)

In this way we come to see that, even in relation to the alleged rescue-operations of channeling, we haven’t succeeded in surpassing the original problem at all. We find there is no device to which we can have recourse, that serves as proof against the possibility of deception and illusion. We find once again that we are thrown back ultimately on our own resource, stuck after all with the responsibility of developing our own discriminative faculty, our own will, our own spiritual intelligence able to act as a gyroscopic monitor of information-signals. For it becomes inescapably evident that, regardless the subtlety of the originating plane or quality of the formal Ground, the voice of Self-serving can Speak from the Other Side with as great an ease as any other orientation, and indeed takes up Residency there with as

firm a sense of proprietary rights.

At this point we hear the common plaint: what about the “goodness” of the medium? Doesn’t the “right intention” and positive expectation of the *channeler* tend to ensure the benign intent of the Received Signal? Doesn’t the occult proposition pertaining to the law of the psychic plane wherein “like attracts like”, serve as sufficient safeguard so that we may resume our basic confidence in the integrity of the Higher Ground granted this one proviso of appropriate alignment?

Overlooking for now that this still leaves us with the petitiio principii of having to *assume* just the egoic equanimity on the part of the channeler that’s as problematic as the question of any “guru’s” ego, and that in fact has yet to be proved, we should go to the central consideration in the whole question of

any invited intercourse between planes.

The “Good” Ol’ Boys

Channeling is resorted to in the first place in order to *obtain* what one manifestly doesn’t have; and despite tangential issues, this means most critically certain *Values of Being*. Indeed, the device of “meditation” from which those values are traditionally thought to proceed, becomes the agency of acquiring *information* more colorfully descriptive of those values, in the context of channeling. The *operative* plane from which all of this takes place, is as a consequence maintained at the ordinary low level of mind-body integration characteristic of 3rd density consciousness as a whole. Indeed, the channeler takes pride in the preservation of just that humble “ordinariness”, displacing all claims to the extraordinary upon the received Source. In this way, we’re supposed to take comfort in the fact that the channeler lays claim to *no personal* merit in terms of Transformative Realization; he’s not purporting to be the source of such fascination but only the indifferent *medium*, thereby retaining his warmly assuring identity in ingratiating commonality with us.

This shouldn’t be a matter of such congratulatory assurance. The implicit confession is that the channeler, no matter how personally oriented to the “good” he may be (and *whatever* that may be in his terms) is functionally established at the same, essentially non-transformed level of mind-body harmony and integration characteristic of the mean average with which he takes such proud identity. He is, by inference, only as integrated and properly aligned with respect to the volitional axis, as everyone who goes to consult him.

His very *method* of “reiceval” may be traced back as an extension of the initial way in which the whole “foreign” theme of *meditation* first intersected the framework of the Western Psyche. A couple decades ago the debilitating tension of Western-technological living issued an implicit call to alternative “technologies” able to solve for that specific problem. And if we remember, it was the “Maharishi” style of “**Transcendental Meditation**” that answered to such a call. Thus we get our impression *to this day* as to what “meditation” amounts to, through the ripples issuing from impact of that first imported influence. All those subsequent, bandwagon techniques either borrowed or domestically developed took their acceptability—and measured their “correctness”—from that original template.

Meditation as understood in the *Initiated* Tradition is a technical means of augmenting a *general practice of spiritual orientation* and whole, mind-body intent whereby the subconscious systems are integrated with coordinate intensification along the conscious Axis to the degree of producing a *combustion* lighting the filament of that Volitional Line, and “turning on” the spirit-lamp of direct Awareness. The hallmark of such Meditation is a poised, *alert receptivity* that carries through all actions. Meditation as understood through

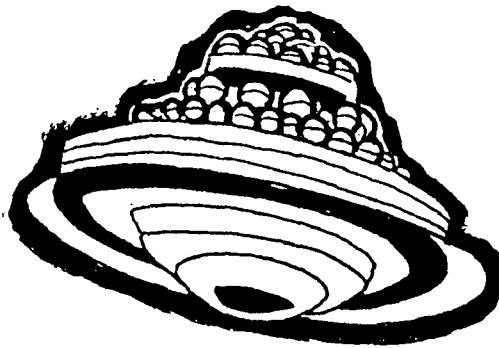

franchise-versions of the Maharishi-styled technique, is a means of rendering the mind-body system *passively* quiescent. It is relaxative, to be sure; and that answers adequately to what was, in the aggregate, a rather shallow "call".

Such a trance-like state of semi-drowsy *passivity*, however, has come to constitute the *standard* of all that we think of and accept as belonging to the subject of Meditation. Any number of such methods are bandied about on daytime talk shows, and consumer-consciousness now knows how to "count backward and lower yourself with eyes closed into the deep well of your inner self" as well as it knows how to measure out soapflakes in the washer-cup. (It is more than telling that the "Hilarion" material, in contradistinction to the overwhelming body of channeled material the sources of which specifically *abjure* giving technical instruction, blithely proffered just such a "countdown" method of meditation inducing the type of vulnerable contingency—and entranced passivity—optimum for establishing the invitational configuration of "horse and rider".)

The West has accepted the technology of meditation from its angle as a relaxative, and has exploited it extensively along such lines. In the process it's come to find out that such techniques can indeed induce a deeper state of "rest"; they are, on the pattern of the Maharishi-method, able to establish a kind of minimal, quasi-meditative harmony and integration at the *ordinary, low-level* of common functioning. This becomes the sum of what we tend to know or expect from the category of meditation. We tend to know nothing of a mind-body integration and harmony established at a *higher* functional level than that which characterizes the norm, in deeper congruence and alignment through the unitive value of the Conscious Axis itself.

Leaky Submarine

With the subject of meditation as we've accepted it and tend to know it, there is no basic reorientation that would belie the *standard* orientation (in which the self-lumining "light" of the conscious axis is chronically displaced, through its divisive conceptual categories, as "focal reflection" scanning the nocturnal fields of subconscious identity-patterns and vital-survivalist imperatives). Rather, through the accepted, passivity-oriented meditative methods it's the *autonomic* system which is set in ascendancy as the result of effectual submission to the murmur of subconscious processes; the subsequent, diffused focus lowers the light of consciousness gently down to certain, subconscious depths so that those levels and spontaneous springs may be refreshed at the *expense* of the conscious or volitional system. Rather than *leaving* the subconscious processes to their uninterrupted business as in sleep, here those processes benefit from a slightly different order as consciousness slips silently into their field and "loans" them a certain value of implicit unity (borrowed from the conscious axis) which they may momentarily appropriate in more direct manner. Since however those subconscious processes are never by this means oriented and aligned *with respect to* the conscious channel and thus the awakened value of mind-body unity, they necessarily slip back from their "optimized" degree of meditative rest under strain of compulsive ego-resurgence, bounding back from the ordinary (non-transformed) level of habitual functioning.

It's as if, rather than the subconscious processes being intentionally turned in integrative amplification toward the spark of consciousness abiding in the "central channel", so as to kindle it with their combined energies of coaxial intensification to full flame, that conscious spark is instead lowered down into the well of those uncon-

scious processes themselves (in displacement from its central, axial locus) loaning them its integrative light to be used at their ordinary, low-level of interaction until it's altogether extinguished in the slumber of their depths. This has the effect of temporarily "unifying" the subconscious processes so as to make them a suitably receptive vehicle only *deprived of the spark of consciousness* belonging to their own central axis, putting them inferentially in a position prime for the structural invitation of a "Conscious Light" not part of the specific integrity of that axis but finding an adequately airtight vessel, accommodatingly empty of "driver"!

Thus the "goodness" of the personality is, at such a common level of mind-body integration, strictly subject to the specific tolerances of the axial harmony thus far established through the consciousness-systems. It is strictly a function of *egoic habit*, not the condition of a realized integral ground. The shallow state of mind-body integration from which the channel-mediator assumes the "appropriate" passivity to receive, functions through a volitional axis that is effectually *empty*, the value of consciousness-in-itself being chronically displaced into the subconscious habit-channels of the frontal or vagus-current. The "goodness" which may seem to formally extend the invitation is a shifting, unstable value based on egoic estimate rather than unitive congruence with the Divine Order; the real constant presiding over any such invitation is the effectual *emptiness* of the Conscious axis displaced into reflective, subconscious habit channels, that would otherwise serve as illuminated instrument of that Order. The response which is elicited from such a passively oriented invitation therefore answers to the real constant, the *actually* consistent factor presiding over the whole proposition. The real invitation doesn't issue from any well-meaning *attitude* based on personal self-estimate but from the operative emptiness of the (relatively unintegrated) axis of *will* implicitly requesting a replacement-filament of volition from a Source superseding its own technical level.

Such assumed *passivity* as preparation for the receipt of an anticipated, Otherworldly Beneficence, thus amounts to an invitation for that empty volitional channel to be *filled*. This is, in fact, a very contingent and vulnerable orientation. Any Intelligence of high integration and proportionately powerful Will functioning through the deeper densities, *whether positive or negative*, is in perfect position to infuse that vacuum of the volitional axis without challenge. Nor is the common counsel (cited even by the "human" authors of the *Ra material*) to the effect that one can invoke the protection of the Positive God-light under such circumstances so as to ensure the alignment, any sufficient corrective in itself; for in order that such an invocation carry practical weight, it's necessary that there already *be* a sufficiency of corresponding substance in the channeler. The personality in question

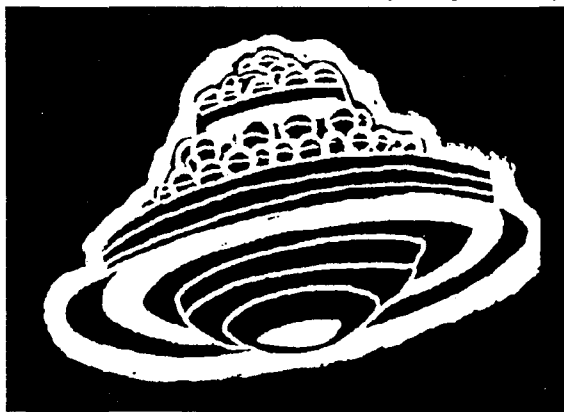

must already be substantially committed in positive integration and alignment *congruent with the value of Light called upon*, in order for that Call to have any basis for effective Response. Otherwise it's an empty invocation, and needn't have anything of automatic "expectancy" about it at all. Here we may note the Gospel account in which an Apostle, purporting to cast out a demon in the name of Christ, received the retort of that very demon: "Him I know; but who are you?"

This same basic passivity as the implicit orientation assumed in channeling, also accounts for those odd fluctuations in the quality and character of material coming from the same—ostensible—Source. It may well be that a channeler one day receives a truly positive communication, and the next a communiqué which though superficially similar is exposed to subtle detection as a specifically negative source. It's as if, in other words, the channeler had glided imperceptibly over

an invisible broadcast band, shifting from one station to another and never noticing the difference. ("Positive" sources do not, incidentally, interfere as a rule with this negative drift as they must honor the implications of free will in every case.)

Even more to the point in a certain sense, we must ask ourselves ultimately just Who is interested in establishing such Communications with us in the first place! Beyond even the valuation of Positive or Negative in relation to these sources, we ought to be asking the more central question as to what order of being, what class of intelligence or spiritual development seeks to respond to the inquiry of 3rd density consciousness through these specific means.

Here we may receive a surprise; for, even amongst those Sources which we can identify as safely "positive" in the sense that they communicate in conformance to the essential harmlessness of Cosmic Law, there is that formerly noted, by-now-notorious *lack of concord* as to the most basic tenets of certain foundational points. And it is in just this *lack of concord* that we may be able to discern the giveaway signature, the real hallmark that distinguishes the majority of "channeling" whether positive or negative.

Let There Be Light Reading

Let us return to our original, inspirational guideline mandating us to perform that needed work of cross-correlation and comparative indexing of otherworld Sources: the "Christ" material of Virginia Essene and Ann Valentin. Here is a Source purporting to emanate from the very Personality of "Jesus" (not just Christ-consciousness in general); and an additional source of this channeling team identifies Itself as the "Gold and Silver Rays", represented as nothing less than the original creative powers of God with whom the Christ-personality is now in intimate association (these major Actors are accompanied by a lesser supporting cast, including "Sananda Lord of the Omniverse" humbly so-called, who—revealingly—is described as a kind of "cosmic coordinator" of UFO activity and communication; and an entity identifying Itself as the Archangel Uriel).

When we turn to such a Source to consult what It has to say regarding such important, foundational principles as the nature and genesis of the Creative Process, the population-origin of earth consciousness, the character of spiritual development and so forth we immediately encounter an interesting phenomenon. All consideration duly taken into account of the reasonable need to "tailor" such complex subjects for the general level of earth-consciousness, we still find a peculiar recitation of the Creative Process—for example—being advanced by no less than those Authors of All Creativity the *Gold and Silver Rays* Themselves. In most Grimm fashion they proceed to regale our apparently pitiable comprehension-level with the "information" as to how, prior to forming any other aspect of the cosmos they first fashioned an experimental globe out of their own complementary materials (as emanated from the obelisk-presence of the centrally situated Creator) to function as prototype of our very own Earth. This account of course has none of the actual sense of Creative Superfetation (of the profusion of simultaneous foci from which the multidimensional probability-patterns of the universes come endlessly cascading) described very nicely within the precisions of language-limitation in Book III of the *Ra material* or the first Book of *Seth*—or which is indeed accessible at any time to the Viewing of a consciousness appropriately integrated either with the 5th density of Creative expression or any adequate subreflection in "astral" or "etheric" terms etc.

In comparison to direct "yogic" observation, or the accounts cited above, the "Rays" explanation has all the piecemeal ponderous quality of the ordinary focal *mind*, which is indeed the targeted recipient of such a recital without respect of any esoteric facts at all; such "teaching" operates out of a clear calculation aimed to ingratiate the lowest common denominator in the comprehension-range of that slow faculty.

Such a primitive, literal-Genesis model of the Creative Process

is reminiscent of another curious allegation found in the *Cosmic Revelation* book, i.e. that the type of exquisite interdependence characteristic of our planetary life is expression of some *unique design* involving free will and is *not* indicative of other planetary life in the galaxies (!). What can we make of such remarks? other than resorting to the weak excuse that the "channelers" may be imperfectly interpreting the communicated impressions in oversimplified terms of their own cosmically-parochial psyches.... While this may be in certain instances, there's too consistent a thematic reinforcement throughout the material to allow us safely to ascribe the whole business to randomly-bad interpretation. There seems to be a concerted effort to impress us with the *special* quality, the wholly unique character of our situation as "caretaker"-denizens of C-ton (the cosmic name for Earth, we're helpfully informed) even to the degree that such patently fatuous statements court the danger of screening out any but the most gullible, unthinking or unreflective.

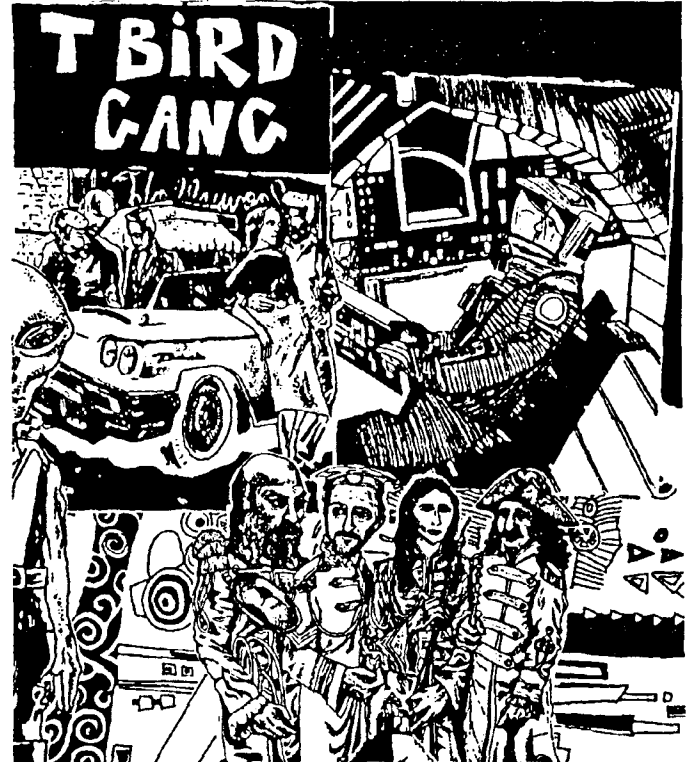

A case in point is their account of the original population-seeding of Earth, and the subsequent Fall precipitated by the Free Will-test furnished through the (negative) Black Ray influence. According to this account, some 8 million years ago a flotilla of luminant Souls already substantially awake in cosmic consciousness came to our newly-prepared Planet in the upright intent of fulfilling their Divine-contractual role as spiritual caretakers in the development of Earth (excuse me, C-ton). For a million years this atmospheric network or luminant aura of Souls kept in dutiful communication with their planetary and galactic home bases, hovering over and tending the unique life-forms of the planet as per telepathically-beamed instruction; then the *uninvited intrusion* of the Silver Ray's bastard offspring the Black Ray, set up a negative vibratory pattern progressively subversive of the souls' recollected commitment. Gradually, so the account goes, the larger portion of souls failed the initial test of free will and fell into amnesic lapse with respect to their contractual duty, becoming so involved and progressively identified with the physical lifeforms ostensibly under their care that the Creative Powers had to assemble an emergency committee of cosmic engineers to construct the most ingenious "device" ever seen in the creations, i.e. the *human body*. Such a body was specially made to house the dimming Light of the soul so that It wouldn't be extinguished in forgetfulness altogether. Through the special device of

reincarnation the souls were supposed to progressively awaken to, and resume conscious participation in planning the fulfillment of, their original caretaker-contract.

Now, this may seem superficially similar to other accounts (the spurious "Hilarion" account, remember, indicated a similar Biblical-echoing saga of negative subversion and fall); the Pleiadeans in the Billy Meier material (edited by Col. Wendelle Stevens) claim to have seeded this planet originally with their own offspring so that "we" are their legitimate cosmic children. And the *Ra material* suggests that there was some initial, genetic intervention at the dawn of 3rd-density earth consciousness, the unanticipated negative repercussions of which originally inspired the institution of *quarantine* (see last month's issue) in order to prevent undue influence of *either* a "positive" or "negative" type. The Edgar Cayce material describes a progressive coinvolvement of migrating souls and the plastic matter of the earth-plane; and Ken Carey's *Bird Tribe* source similarly describes the creative "quickening" of the otherwise inert material of earth through the increasing proximity of approaching Souls.

Yet the *Ra material*, proven in many other ways to be the most reliable single source of all, places initial planetary seeding at a distance of 75,000 years, not eight million (or seven million if we date from the "Rays" confection of the human physical vehicle). Taking the *Ra* source at Its Word that It isn't very good with dates, we may well suspect that—from Its oblique-channeling angle—It's perceiving the initial infusion of a *particular* life-wave of consciousness, not the "first". More importantly, *Ra* identifies the "seed" entities of 3rd stage planetary consciousness as originating primarily from a former *Martian* cycle of development that had failed satisfactory completion on its own ground; and this "strain" of transposed soul-seeds in any case followed the same line of *consciousness-unfoldment* and progressive development through the lower densities as the indigenous, 2nd-density entities promoted to comprise the other major portion of 3rd-stage soul-inhabitants 75,000 years ago.

In light of this last characterization, we may take a revealing second look at the "Rays" account of "how we came here", with its inference as to our mission, our duty and our destiny.

Falling Apple, or Rising Seed?

According to the Essene "Rays" we come from a soul-group that doesn't *evolve* from the less-conscious densities, but which *falls* or *devolves* from the Higher Planes. The idea here isn't to *unfold* the latent seed-germ of a spiritual consciousness never previously flowered in our particular case, but to *recover* it from the consequences of an initial mistake. The obligation to *recover* a status of *former* Spiritual Glory imposes a mood which the prospect of *brand-new* flowering doesn't share. The first is a restatement of Biblical culpability.

There is however a consequent, internal contradiction of rather significant proportions embedded in the Essene material; for, if the object is to recover the knowledge and status of that spiritual glory existing *before* our Devolution had been mercifully straitjacketed by the physical body, then it would seem that the ascension in consciousness to those higher states of Being between incarnations would—in itself—fulfill the requirement, and would short-circuit any "return" to the physical as wholly unnecessary. Obviously, this isn't what They mean to imply; for it becomes increasingly evident from the reiterated signs of the material that the "Rays" intend us to fulfill the alleged initial contract entered upon in "full Consciousness" with the Divine, as caretakers of Earth, and this absolutely regardless whether we actually recover that Glory of Spiritual Awareness as unencumbered Souls.

Incidentally, the idea that we progressively evolve through the densities as consciousness-units is not equally subject to the charge of "internal contradiction" that characterizes the Essene-Rays account; the exposure of the progressive (or procedurally evolving) soul to relatively free inner states between incarnations is never held as

the Aim or exclusive Point. It's not a matter of some "old" consciousness reexperiencing its specific functional Identity so that it can simply walk away and resume it, like a recovered amnesiac going back to his "former life"; this is a Platonic misread of the afterlife interlude in which the Eternally-Awake Ground of Consciousness reexperiences Itself from the ever-living fount of a fresh perspective—such a fresh perspective does not then just step back into a ready-made role, but progressively develops the implications of that after-echoing Being through terms of its own unique patterns, seeking forms of integration and higher-level unities that did not, in that sense, ever exist as a flower of Soul-consciousness.

The value received through those intervals of discarnate exposure serves as purifying stimulus and Standard subliminally belonging to the soul-record, encouraging a practical intensification or dynamic integration on all levels in order to draw the ordinary incarnate locus of soul-consciousness into progressively-awakening congruence with that common Ground. The "object" here is not simply recovery from the makeshift expedient of a preventive or "prophylactic" physical form, but rather the thorough Awakening of all parallel, developmental levels of Consciousness inward or outward in whatever medium as a true Spiritual Increase, bringing the dimension of Divine Awareness to every seeking facet of the multidimensional being through all its respective Vehicles so as to impart to each of its planes a precious value or Absolute quality never previously experienced in integrative Unison.

It becomes increasingly evident, then, that this scenario of our seeding and fall as narrated by the "Rays" is not a reflection of the spiritual or physical facts, but a propaganda meant to instill a kind of "cosmic guilt", as it were, shaming us into fulfilling an alleged contract that we entered into in the irrevocable responsibility of "Full Soul-Consciousness". Indeed, so patent does this become that we can only marvel at the give-away desperation seated in the motive which causes Them, at one point, to make the astonishing pronouncement that—if this ostensible caretaker role is now fulfilled—they will generously waive all further reincarnational requirements!

"Incarnation" is a matter of Identity, and levels of specific functional identification; it is not, has never been nor can it be an arbitrary matter of fulfilling mechanical conditions. If the technical fulfillment of conditions is meant to promote the proper spirit of such identity-transformation, we must ask why the emphasis of the Essene material is never on Spiritual Awakening per se but "awakening" to a specific, caretaker role. Whose "garden", we must wonder, are we being coaxed, cajoled and wheedled into tending through acceptance of a cover-story purporting to explain "how we got here", and instilling the proper mixture of guilt and ego meant to motivate us into honoring what we're ostensibly supposed to be "doing here". (The "guilt" comes from our alleged culpability—acquired through the accountability of full consciousness—for the Fall; the "ego" comes through constant encouragement for us to see ourselves as caretakers of a planet unique in all creation, special beyond all others in design and destiny). Far from any acknowledgment that the patterns of creation are supplied primarily as the occasion of our awakening, the "Christ" entity and Rays would have us subscribe to a reverse standard in which consciousness takes form in order to be the caretaker of creation. In light of this explanation, the world is not the parturitive medium of Consciousness but rather consciousness is the vehicle for the husbandry of the world.

This promoted viewpoint just may have something to do with a constantly reiterated theme of the material, i.e. that the present orientation of earth consciousness poses an immediate threat to galactic and planetary neighbors travelling the invisible etheric pathways; due to our misuse of atomic weaponry and secret forms of "scalar" mayhem (that undo not only the delicate fabric of subatomic space, but the universal Ether that comprises the short-cut "tesseract" for commuting space vehicles.) All of this may serve to account for why the actual teaching of the Christic "World Teacher"

is uncharacteristically short on the spiritual education of consciousness, and dogmatically long on warnings and instruction with regard to the proper care and feeding of atomic materials. After all, as we learned in the last issue, the atomic and subtending etheric fields of which this physical density is particularly rich comprise the nutritive energy-medium of a number of systems that "feed into" it from other levels and densities. It has been noted by several commentators, including Wilhelm Reich, that many "saucers" come within our boundaries to feed on the energy-rich atmosphere and physical resources furnished by this precious sphere.

May we not see then a lurking "identity" behind these cosmic masks more congruent with the actual character of the material, rather than the purported character of the entities?

With Friends Like These...

When the "Christ", the "Gold and Silver Rays" et al. inform us that they will only extend these warnings to us for a limited period because they have other places in the cosmos they need to attend to as well, they not only undercut the "special" character of our own focal zone but inferentially describe a mode of existence that is peculiar to say the least for a pair of All-Creative Principles (but not at all peculiar for saucer-saddled entities who do move in just this manner from one galactic point to another). When the "Christ" describes His relation to the great God-lozenge of central Creative Power (taking up a very localized residency at a particular galactic point) as that of being able to closely approach but not fully enter Its hyper-intense field, we do not find ourselves in the presence of a description that originates from the 5th density of Creative Mind, specifically cited—by Ra—as the platform from which the actual Jesus-entity would channel; rather, we find ourselves contemplating a description that succinctly characterizes the reality of 4th density space/time UFO entities for whom the Creative God-power seems to intersect as an emanative Node into the astro-physical field at specific, localizable junctures in the form of a Dome or Obelisk, a Door or luminant Lozenge, and who—as in the Andreasson report cited last issue—are able to approach that obtrusive Point but are unable to bear Its intensity in exact alignment with It. Couple to this the fact that "Sananda, Lord of the Omniverse" is characterized as UFO/space-entity coordinator (amongst other heady aspects of His job-description) and we have completed our fill-in-the-hidden-numbers portrait that exposes the actual identity of the beings beaming in behind the masks of "Christ" and the "Rays", etc.

There is no "malevolent" intent here. These are "positive" entities. But there is deception. This circumstance exists as an anomaly to us due to our misperception of what it means to be a "positive entity". Positive entities so polarized at 4th density level and higher, are "positive" by virtue of their decision to adhere to Cosmic Law, to subscribe to peaceful and cooperative means. They're not "positive" in the sense that they exist to impartially help us and promote our spiritual awakening. They have taken specific, characteristic paths in space/time with very distinct destinies, and though they exist in social/memory/complex harmony with one another their sheer, incarnative situationality imposes conditions that describe the priorities of their own particular group. Thus their subterfuge "message" to us, assumed under the guise of the Teacher most revered and sacrosanct on this planet and thus most likely to be listened to, is "benign" in the sense that it encourages our very necessary care of the planet; but it is not a message that conveys a real teaching, of maximum benefit to our own spiritual development in line with our unique destiny and

collective Path. It is a message which, while promoting the positive values of our planetary husbandry is still basically self-referred, for it's meant primarily to goad and shame us into maintaining—or prolonging the life of—a sphere which functions as a cosmic filling-station for them. They are interested in the preservation of the connecting spacelanes of the interstitial ethers; they are not interested per se in our spiritual development, which is why they're perfectly content to paint us a picture of spiritual accomplishment consonant with our roles as glorified gardeners for "their" satellite Resource.

Can "positive" entities out-and-out lie like that? Yes they can. And do. We do not see reality directly as a Pirandello dance of mutually reflecting, coinhering and magically counterchanging identities. They do. Thus there is little wrong, as far as they are concerned, with the assumption of any identity as manifestly provisional as their own.

Indeed the phenomenon of channeling altogether is most susceptible to the blandishments of "positive" and "negative" beings of the space/time densities neither of which are, by constitution, of optimum spiritual benefit to us. After all, didn't we note last month how curious it is that meditation, ostensibly a direct vehicle of our personal awakening and intuitive alignment with the Fountainhead of Gnosis, seems to be so neatly co-opted by the distractive offshoot of "channeling", which substitutes a verbal description or message of further encouragement for us to assume the inert horizontality that passes modernly for the "meditative" mode? Understanding this,



isn't it wiser to forgo the passive (and thus "easy") path of turning our spiritual development over to another entertainment program, and recover instead the original sense of meditation as a direct spiritual empowerment that adroitly bypasses every intermediate voice of every intervening plane that would turn us into a satellite-functionary of its own "cosmic trip"?

Each plane, sphere and density is furnished the indigenous spiritual teachers and teachings appropriate to it; and despite our recent "disenchantment" with the idea of living teachers, only such teachers are valuable to us as they share the same physical consequence and destiny as ours so that they may uniquely participate in as well as know our real requirements, while at the same time embodying and practically directing the optimum Spiritual Value for the fulfillment of our unique destiny.

The "positive" beings of the channel-frequencies, then, are of two types:

Time/space entities of "disembodied" status, flush with "helpful" ego eager to impart what's only being learned within the insulated framework of afterlife rest and review, and who are thus limited by the special, subjectively-reflective requirements of the framework. Any such entity is confined to the bubble-like protection and internal, "angelically" harmonious support that thoroughly screens the soul's vulnerable status from that unfair advantage belonging to the aggressive deception of the "dark teaching", (and for whom therefore the "negative" as a practical fact does not exist except in the learning situation where it may be identified at its origin as an internal potential and projection). Such an entity is not balanced with respect to the Whole and the complementary systems of learning-organization; it is preponderantly influenced by the hermeticism of its own present schooling, and is therefore minimally helpful. All such "disembodied" entities need to appropriate the "fleshly" vocal cords of the channeler.

These entities are not the same as Inner Plane Masters; the latter in fact proceed from levels of time/space organization also, and therefore require no space/time vehicle as do communicating UFO

entities. But Inner Plane Masters are not confined to the "contents of the classroom" as are the eager, between-life soul entities. They are more like the schoolmasters Who walk those time/space halls, not restricted to the curriculum taught in any of the quarters but bringing the whole experience of the World to those cloistered seats of learning. Inner Plane Masters do not need to borrow the physical vocal cords, and do not in fact enter into relation with incarnate beings through the mode of channeling at all. They respond only to the overall development, balance, intensity and will of a real spiritual aspirant who has achieved a very formal threshold of readiness (a threshold that cannot simply be "claimed" as index of the ego's desire). The Inner Plane Master communicates to the nervous systems of the ready aspirant in a kind of energy-embrace and harmony, but does not communicate through those systems in the sense of appropriating or commandeering them. The Inner Plane Master, where the potentials of soul and circumstance warrant and allow for it, always inclines the aspirant in the direction of the embodied spiritual teacher Who completes the Spiritual circuit for the student (always leaving the identification of that living teacher entirely up to the discernment of the student).

The other kind of "positive" channel-entity, is the space/time UFO being. We have already learned the limits to which any such being, situationally aligned with its specific destiny, can be helpful. That we ought not to be so eager to channel such beings, doesn't mean we're not approaching inevitable interaction with them. Indeed we will enter into formal relations with them as a planetary soul-group when that potential is ripe. But our relation to them should be that of peers, establishing cosmic bonds in terms of treaty and accord as with the relations of countries operating in the harmony of mutual respect. We should not allow the tendencies that arise in the current (aggravated) state of manifest imbalance between our respective levels to encourage a relation of "benign colonialism", as is happening at present. In order to prevent this, we must restore the idea of meditation as handmaiden of our direct, unmediated development, allowing those values natural to our own Being and destiny to flower in the form of faculties radiating a self-evident sufficiency affording

no uncertain notice of our spiritual autonomy, to be respected on the instant by all beings of good will.

If one is yet enamored of the idea of "channeling", one should heed the advice of the best of the channeled sources, i.e. the Ra material, and follow the method of Elkins et al. in resorting to the balancing correctives of group activity properly insulated and prepared.

"Alien Nation" Is Alienation Without the Intervening Space

Oh yes: there is the recent disclosure, through material such as that of Whitley Strieber (Majestic), Bill Cooper, the allegations of John Lear, etc. that the government has been interacting with and even doing the bidding of (largely negative) UFOs since 1947. While initiated understanding confirms that there is validity in this business of "Roswell" and "MJ-12", it is important to note that, regardless the objective facts which you'll progressively learn in the revelation of the '90s, one of the tactics of the Negative Beings is to propagate, expand and exaggerate the magnitude, the possible horror, and the despair of such information-content so as to deflect the orientation of personal power and render a collective sense of hopelessness, of powerless passivity and ineffectuality before the monolithic monstrosities of the "hidden government" and the experimental labs on the "dark side of the moon". Such an induced sense of helplessness, remember, moves us toward modes of meditative passivity from which we hope to elicit the compensatory Authority of a substitute self-power "beyond" us; and it adversely affects the immunology system making us even more subject to the toxic depredations of our gross ecological mismanagement, and thus weak beyond resistance to any wholesale negative invasion that could be marshaled against us. People such as Bill Cooper who, unlike Strieber, understand and rightly warn against the negativity of the government-alien interaction, may be "modern-day Paul Revere"; but our powerlessness in the face of all this is not the message. The even-more-intensified mandate for our Spiritual Awakening and renewal, most certainly is.



355-A-27

FORCES ARMEES

23 JUIN 1992

N° VSRP 3147



ETAT-MAJOR GENERAL
Etat-Major de la Force Aérienne
Section Relations Publiques

Quartier Reine Elisabeth
Rue d'Evere - 1140 BRUXELLES
Tél.: 02-243. 4939

Dear Sir,

Your letter dated 2 June 1992, had all my attention.

I regret to inform you that the Belgian Air Staff is not able to provide you with information about the UFO subject.

Since we lack the authority to give out information in public any longer, we can only refer to the following organization, which cooperates in this regard on a regular bases :

*SOBEPS
(Société belge d'Etude des Phénomènes Spatiaux)
Avenue Paul Janson, 74
1070 BRUXELLES.*

For further information concerning this matter, we therefore advise you to contact the above address.

Yours sincerely,

A handwritten signature in black ink, appearing to be 'M. Emonts-Gast', written over a horizontal line.

*M. EMONTS-GAST
Lieutenant-Colonel
PR-Section*

*Mr. Nicholas REDFERN
20, Paradise Lane
PELSALL
WALSALL
WEST MIDLANDS
WS3 4NH
GREAT-BRITAIN*

355-A-28

Relationship, Connections and Generation of Entities

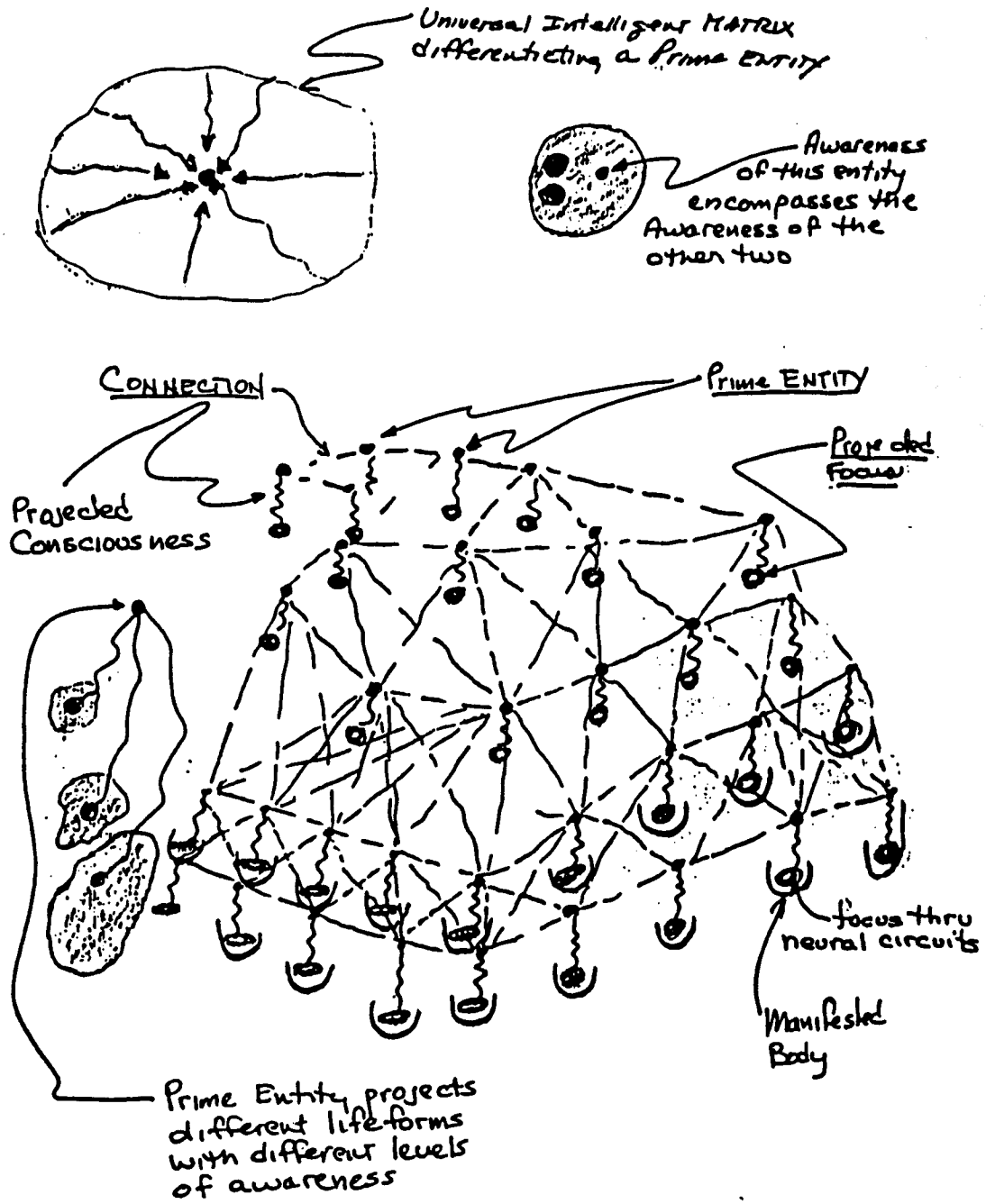

Conversations With the Essessani

The Essessani are a hybrid race that functions outside our linear time track. It is apparent from reconstructions of their physical appearance that their genetic structure has components that are common to both Reptilian and Homo Sapien. They are considered to be advanced in both Technology, the Mind, Service To Others, and have the capacity for group awareness and knowledge of other time streams relative to both themselves and others.

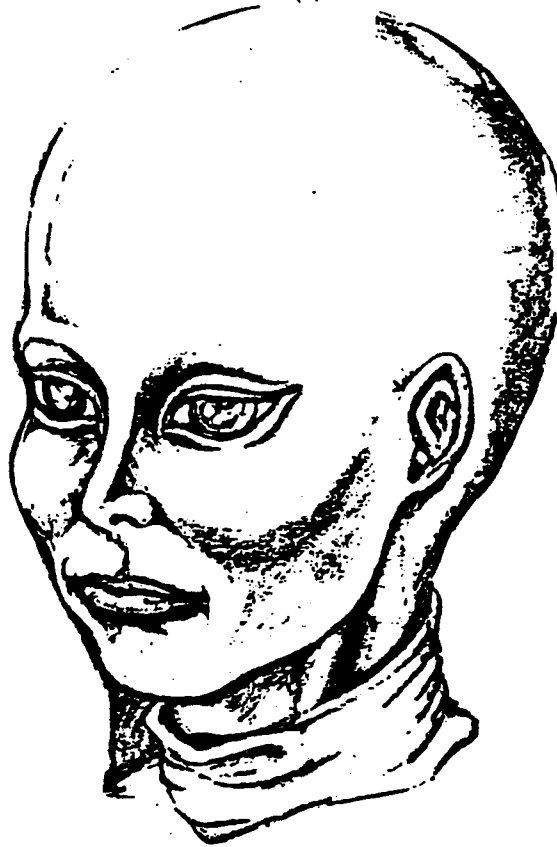

Representative Image of An Essessani

The main contact that has been made with the Essessani is through contact with the entity known as Bashar, an entity who seemed to combine a Seth-like holistic awareness with an extraordinary sense of humor. What follows is an extract of some of the dialogue characteristic of this interaction:

001: You create time to exist

002: We will give you a bit of illumination, regarding the other species upon your planet, that exists within the idea of the same level soul which you call the whale and the dolphin in that way. You being the idea of the land human, and they being the idea of the water human. You are the same soul type. You are different in terms of your application. There is more than a little potential for you to communicate very openly and very easily. Recognize, in this way, that they have been receiving communications from other civilizations for thousands of years. You have been receiving these communications, but only now are you beginning to pay attention. In this way, recognize that the dolphins, that sentient form, has much to share with you about the methodologies of allowing your self to open up and receive communication that is being sent to you always. Its mostly on the frequency you would call empathy that you will feel these communications. It is emotion, feeling...that will allow you to activate those facets of your imagination that will give you the recognition that you are in touch with many forms of consciousness, by definition, by existence. By right. In this way, you are never out of touch. You are always in connection with everything. You can utilize interaction, whether physically direct or emotional, or through your imagination doorway to invoke assistance from the cetacean life form you call dolphin and whale. Simply, in this way, go within and invoke an image in your imagination of a dolphin form floating before you. Allow yourself to recognize the idea that as you invoke any feeling or image within your imagination, into a reality no less real than what you experience to be your physical reality. Your beliefs and your bias towards thinking are what appear to give your physical reality more validity than the reality in your imagination. You create the illusion of the linear time frame in which you exist. Now you are beginning to enter a phase of your existence, your transformation into 4th density reality, that is the beginning of allowing you to know that all you have ever perceived for tens of thousands of years has only been the product of what you've imagined your reality to be. It is that malleable. We are not speaking in analogies. It is that literal. It is that simple. You are, right now, dreaming in a very real sense of the word. Your imagination is the channel through which you can link physical dreams with non-physical dreams and see how the physical dream is but an extension of all that you are, as a non-physical being. As an eternal being. In this way, allow yourself to allow the imagination to provide you with communication from your dream non-physical higher selves, your oversoul. Your imagination is simply the tool that is tuned to your vibration. It can only, by definition, give you what will work for you. Any time you need a method; any time you need a way, trust your imagination to give it to you. It can only give you what by definition is the vibration that represents the path you chose to be, if you are willing to trust and not judge it, you will find that your imagination will always keep you consciously on the path you chose to be.

003: Many individuals are now experiencing some transformation in the throat chakra. It may transfer into your sinus area as well.

Question: Is this connected with my channeling? Answer: Yes , for there is the opening in that area for all of you. The strengthening of the throat chakra..the balancing of the area of intention in the solar plexus.

- 004: What you call the pituitary gland, the pineal, and idea of the base of your brain will form a trinary structure that will create an apex at you crown chakra. When you become allowing and linked in that way and sensitive to the vibration of your planetary force, 7.5 cps, you can become in touch with all other mentality on your planet, and extend your senses out the top of your head in the crown chakra and be in contact with all other levels of your consciousness as well. It forms an energy pyramid that allows communication from all levels in your being, and extensions in your society. You cannot receive unless this is open. Your imagination will assist in developing this. Any time you do allow yourself to be conscious, you are receiving information, those sensors are functioning together and are open. When you are tuned to that frequency, you receive a similar frequency.
- 005: All pain is judgement
- 006: If your positive dreams were manifested in your physical reality, would you be ready to live them? If your answer is: "I can't imagine them..." then you have your answer as to why they are not manifested. When you allow your imagination to function as an open link between your dream and your physical reality, then you will let your imagination do its job. You will not constrict the flow of imagination. Open the conduit. The channeling process helps open the conduit. Trust in your intuition is knowingness in how you need to manifest the opening of that conduit.
- 007: Everything that you decide to do in your life is significant and valid, or you would not have conceived of it at all.
- 008: You can only, by definition, conceive of the things that are pertinent to your existence.
- 009: Although Yeti and Dolphin are from a different vibrational density they share the idea of instinctual knowing.
- 010: Hawaii is the heart chakra of the planet.
- 011: You have but to open yourself up to All That Is, and you will automatically grant to yourself any mode of transportation that you require.
- 012: The incidents of the shuttle disaster and the Libyan scenario are being used to open up the idea of compassion around the world. It exposes vulnerability of both parties out in the open. Communication can be shared out in the open for all to see.
- 013: All is in a state of motion. There are some ideas that are beginning to anchor. This is time of limbo, in this way...a time of infinite probability. It is all completely up to you.
- 014: Nothing is in you in the sense of the space you occupy. You can take upon you an associative vibration. In that sense, all that you desire to be with you is always with you. You can tune into and out of what you will. All associations of that nature are through agreement. It comes in the fashion that serves you. When you no longer need it to serve you in that fashion, the fashion changes. But it is always with you. Not because you need it, but because you have agreed to share an idea and become an experience. Allow the energy to flow, and you will manifest all the answers for yourself.

015: If you have a dream, and it goes into a theory , that is a devolvement.

016: All situations serve you, and the vibration you allow yourself to be will only allow that effect into your reality. For all situations, are fundamentally neutral. You give them meaning, positive or negative. When you assign a meaning, you invite that reality.

017: If you believe you need to be protected, you are inviting the attack.

018: Do not go in the face of your belief. You can change yourself to whatever degree you are willing.

019: The speed of light is the vibrational limit of the 3rd density reality. If you take that and divide it by the circumference of the planet, then you will have the frequency of the planet. 7.5cps

020: The limbo state: the state where all probable realities that you can possibly allow your civilization to become exist equally. As you begin to chose, the probabilities become more and more and more solidified.

021: Info re Greys: Tall grey being, 3 fingers and thumb.

There are many focal points within that communication. Many connections, within you to different ideas of origin.

Zeta Reticulans are much shorter.

Question: What is the purpose of the contact?

Answer: To open up ideas so that you discover more of your self. So that you allow yourself to live for the purposes you agreed to live.

022: What are you doing with the sense of difference you have?

023: There are consciousnesses that are willing to assist you to elevate your awareness to different levels, so that some of the information coming through you can take on the nature of ideas that will be reflections to other individuals for what they need to hear through you. You may have agreed to act as a spokesperson, so that other beings who have similar connections may enjoy them through you.

024: When you are infinitely accelerated, you are everywhere at once, and its exactly the same feeling as standing completely still, which seems to be a non-density, but is actually all densities.

025: Why do you believe this or that?

026: If you know that you know, then by definition, there is nothing stopping you.

CREATE THE WAY IT IS FUN FOR YOU TO CREATE!

027: When you assume that where you are is where you need to be and begin to enjoy it and live in the moment, then you will not try to be somewhere else, and that is what will let you get there.

comment by Bashar: Ecstatic explosions of coincidence and synchronicity shall fill your life , and allow you to know you are living as the representation of All That Is. in that way. Living in joy and ecstasy. Living in the moment! Living in the now! It will mean you do not require patience, not will you create impatience, for you are too busy having fun, and enjoying each and every single moment. And because you enjoy every single moment, you will hardly feel the passage of time at all. Paradoxically.

028: (Referring to Nickola Tesla)

Do you understand how he invented what he invented? His imagination was so well lived-in, that he was able to envision the actual device solidly in front of him, and see it in running operation. All he did was copy it. Get the picture and copy it. Understand, he had the ability to see an image, and if the machine was not running properly, it would give an indication that his idea of it was not in exact proportion. His would simply jockey the idea into exact proportions until he saw the machine running properly, then he could, in his imagination, completely and totally take the machine apart, see where there was wear and tear, see how to correct that, improve upon the idea.....that is why everything he built ran the first time.

029: No one can give you anything. You have to create your own version of it.

030: You are your own 100% unique universe.

031: Anything that you share with someone else, any common similar experience, is because you have agreed to create your own version of it in your reality.

032: Every being has their own way of exploring the idea of their existence. It does not mean you have to live that way yourself, nor does it mean you must judge the way they are living as invalid. If you are busy judging what they are doing is less than what they could be doing, you are the one maintaining those effects and those realities in your reality , you are focusing upon them

033: Choose what you prefer, and let everyone else have the right to live the way they want to, knowing that the way they live has nothing to do with the way you choose to live and will not affect you if it is not what you prefer. Preference is not judgement. JUDGEMENT IS INVALIDATING EVERYTHING YOU DO NOT PREFER, When you invalidate something, you become equal to it, and thus what you do not want you become.

You can only in that way become equal to any vibration you are judging. That is what your mythical phrase "Judge not, and ye shall not be judged" means! It does not mean you are being judged from outside... IT MEANS that you become the frequency of judgement, and are locked into a equal level of judgement, with what you are judging. You become what you hate. You have but to know that what you prefer is simply a representation of the vibration you recognize to be true for you. That is what you will live. Living that means that everyone elses choice (you can see it for what it is) will not have an effect upon you, because that is not the frequency at which you are functioning. Allowing everyone to live the lives they choose is granting equality and validation to everything...ALL That Is, which means that you, as a part of All That Is, are automatically supporting everything you do, and letting All That Is support you. If you choose to invalidate any portion of All That Is, how can All That Is support what you are doing? You are cutting yourself off from that communication and support, by making something more than something else or better than something else... more worse or less.

034: Question to Bashar: To what extent are you aware of how well we understand the concepts you are imparting and how well we understood them?

Answer: To some degree, we can feel the fluctuations, depending how willing you are to share the ideas you know yourself to me. The percentage determination will, in a sense, be up to you. At the same time, our view of you is that you are doing exactly what you need to be doing. Recognize this. You are all functioning completely within synchronicity, but many of you choose to function within negative synchronicity, rather than positive synchronicity. You always function within synchronicity. You are always still at the right place and the right time to interact with exactly the individual you need to interact with. Should you choose a negative reality than those situations will be negative reflections. You are still creating from your synchronicity. You are still interacting only with the individuals and within the situations that reflect the way you choose to look at life.

034: Distortion implies that there is a single truth against which you can measure something. There are many perspectives of one idea.

Bashar (speaking of himself and his group)

035: Our ability to perceive what is going on your mentality is the product of your willingness to communicate on an equal vibratory level with us.

There are many things we place within ourselves not to know so we will not interfere with that process. We are of assistance to you when a reflection is given that we can reflect back.

036: (From Bashar) The idea of the blending of my consciousness and the consciousness of the physical channel creates a third identity. The idea of my experience of communication with you is that I experience you, in this interaction, in my imagination. I know that my imagination is real. I know the interaction is going on.

037: Question to Bashar: You said you were channeling through two other physical channels on Earth besides Daryl?

Answer: Five including Daryl.

038: Question: Can you tell me how I can fly down Hollywood Blvd. on a broom?

B: Answer: In your imagination.

Question: Can it be pulled -off in this physical dimensionality?

B: Answer: What is the difference?

Answer: My degree of clarity of perception?

B: Answer: Your degree of willingness to believe ...that there is no difference. Your degree of willingness to not care what other people think. You, in your reality, will perceive them as enjoying what you are doing.

You may have "what is holding you back" might be a belief in you that you know, that you will be experiencing the reality and all the individuals sharing that reality with you will be experiencing that reality, but you might fear that a portion of yourself might still be perceived in this reality to simply be insane.

The hesitation may simply be this: individuals in your society as we have discussed many times, who you call insane are experiencing other realities. What they are experiencing is no less real than yours. What they have not allowed themselves to understand is how to communicate back and forth so that your reality can partake of their experience as well. What you may be waiting to do is to establish the balance within yourself because it is important to you that you do not isolate yourself from the individuals who would label you as crazy. You give them enough time to acclimate to the idea that what you are going to do is possible, so that when you do it all will be able to partake in the experience.

039: Question: I open myself to relationships, and I am totally open and trusting and then...I get hurt

B: I thought you said you were totally open and trusting?

Ans: Initially...

B: Oh, initially. Why did you change your mind?

Ans: Well, something happens, and..

B: Do you understand, that if you are in a state of complete unconditional love and trust, you can't be hurt.

Ans: I guess I'm not in that state...

B: Thank you very much.

Ans: I get hurt, and...

B: Why do you choose to be hurt?

Ans: I don't know...and then I become bitter and vindictive and..

B: What are you looking for when you open yourself up to a relationship?

Ans: Um...love...somebody to love me equally as I love them...

B: Are you sure you are loving them equally?

Ans: No

B: Why not? What are you sure of?

Ans: Right now I'm sure I'm locked in this vindictiveness

B: You're sure of that?

Ans: Yes, and I don't like it because its a lonely place to be.

B: May I remind you of something? If you were completely locked into it, in a sense, you would not be able to not like it. You can only know you do not prefer something when you have an inclination that there might be something else. Knowing that their might be something else means by definition that you are not completely locked into the thing you do not like. It is only up to you to discover that this 'something else' is eqally as real, and that you can prefer to live that way, and to experience that reality, as opposed to the one you are choosing to experience..

How can somebody hurt you when you are choosing to be hurt? The one you need to forgive is you.

Ans: Well, when somebody leaves me I miss them and I'm lonely...

B: That is your choice..to miss them. You are choosing to be hurt. You are not functioning from your self-empowerment and that is why you are attracting relationships that can only reflect that you believe you need a relationship to be complete, and that you do not believe that you are complete without a relationship.

WHEN YOU KNOW YOU ARE COMPLETE WITHIN YOURSELF AND ATTRACT A REALTIONSHIP TO SHARE AS TRUE EQUALS, EACH BEING IN THE RELATIONSHIP BEING COMPLETE, THEN AN INDIVIDUAL CAN COME AND GO IN THE RELATIONSHIP AND YOU WILL FEEL NO LOSS. IF AN INDIVIDUAL COMES AND GOES, IT IS AN ACCURATE REFLECTION OF THE COMPLETENESS OF THE RELATIONSHIP..AND IT SERVES THE PURPOSE IN THE RELATIONSHIP AND IS NOT AN INTERRUPTION IN THE RELATIONSHIP. You are simply assuming that you need a relationship to be complete, so what you are always going to attract to yourself is a reflection of your incompleteness. You will attract someone who will act incompletely, to remind you that it is what you believe yourself to be.

Individuals in your society say that if they could only find their soul-mate , everything would be wonderful.. but UNDERSTAND THAT YOU ONLY ATTRACT WHAT YOU ARE THE VIBRATION OF!

So if you know you are complete....you are already the vibration of knowing that your life is wonderful anyway, then you are the vibration that will attract a soul-mate, because a soul-mate is only a reflection of your awareness of your own completeness and perfection....and your own self love.

PAST LIVES, DIMENSIONALITY, AND CHOICES

As we begin to open the scenarios of what we're calling past lives, we're opening into multi-dimensionality. When people begin to understand that they access each other as one being, they will experience the oneness of being. That will change our ability to see each other's auric fields or to tap into each other's consciousness.

The term "past-lives" is a misnomer. We only use that term because it's a hook, a string people can pull. They see it in a linear way. It's an experience of multi-dimensionality in a linear format. The finite mind has not exercised its capacity of consciousness or extended consciousness, but it can easily relate to multidimensionality through the vehicle of past lives.

Certain souls have predilections to certain dimensions, so that when people say you're an old soul, they're referring to the fact that you have been around in a particular dimension for a long time. Past-life work helps us to recognize our connections to each other. Initially, people remember the lifetimes that are involved in the themes most intimate to them. If a lifetime we shared with another had an imprint, if we remember the other in that context, some part of us will dwell with the other in that context this time. Thus, we come into those interesting aspects of Karma- how we see each other. Connections between beings allow both to assimilate completely what they are experiencing with and for each other, and reshape it in any way they want. That's creation. The more conscious we become of our capacity to do that, the more beautiful our creation.

Bridging is crucial in this lifetime to bring forth the unmanifest into manifestation. We have the blueprints; our very bodies are the proof that we have the blueprints. There is nothing that anyone will ever say to you that you do not already know. You just may have forgotten. What is knowing? Knowing is living, experiencing, merging, being whole. If we can stay away from our judgement, our egos, we can allow the knowing to come in as a pure energy, and we can shape it and create the reality.

The child is the first wave of the bridge to the multi-dimensional self. The next wave from the child is cognition of the higher Self. The higher self is not, in fact, an entity. It has been described as the megaphone of the Soul. It is the mechanism for precipitating the unmanifest into manifestation so that we can create a thought-form so that we can ascertain the answer, so that we can recognize the path. The higher self gives us form. It can speak to the mind and say, "Yes, it's this". It can speak to the emotion and fill the emotions with the flutter of the pulsation of the universe.

When we first learn to contact the higher self, the level of our doubts reflect the degree of separation, our experience of separation, our experience of guilt and judgement. Contacting the higher self allows one to have the tool that will allow the switch from 'victim' to creator.

When we go someplace, we should look for places that have vortices. Our emotional bodies will let go when we enter into a frequency that's higher than our own. The motional body quickens to the frequency of that vortex. It is important to understand that the Earth is a living entity, experiencing all that we are. We don't have to go to a specific place to seek out energy vortices, because we actually live on the whole Earth, although we have forgotten. At first, we may need to remember the experience of the vortex energy in a special place we have visited, and then once we recognize the frequency, we can just trigger it.

Consciousness pervades everything. There is nothing secret in the universe. What anyone else has ever experienced or known as available to us all. There are some who have learned to utilize this truth and expand their consciousness to contact either extensions of their own cosmic consciousness or other entities who might share their expanded awareness or perceptual view with humanity. These are the 'channels' people have begun to seek out in these times. It can be deeply comforting to sit in the presence of someone who is channeling an entity that recognizes you and can confirm your inner thoughts; an entity that can explain the karma of some event in your life.

This is a wonderful symbiotic relationship, in that these entities need to be in contact with us as much as we need them. They have chosen to focus on this density level to further the growth of their own souls relative to the lessons of this reality.

It is important that the knowing and experiencing come directly from within yourself. Being given a piece of information that seems to explain or fit into your own personal karmic puzzle in no way releases you from it or alters your blueprint. The moment you ask for guidance, you must realize that you are abdicating your choices to someone who is still bound to filter truth through the veil of his or her own crystallized experiences.

It is the exquisite higher self that is the source for all knowing. The person tunes into this frequency with the unconscious protective guard in place as thus receives the knowing as if from outside the self. As we release beings from astral memories, channels often discover that it is their higher selves which have been guiding all along. This revelation is a very profound experience for them. Inner guides are a part of our multidimensional resources as well. Each guide has a frame of reference which relates to our inner development and corresponds to its own level of expertise. One of the troubles people seem to have is that they become addicted to their guides. If you let this process work the way it is supposed to work, a guide/entity will come in and say, "over there," and you go over there. Then that guide will go away — unless you hold that guide in bondage — and a new guide will come in. Guides come to pull and twist us. Do your work with them and let them go. That's how we grow. You must experience the light that you can create yourself.

You will always be attracted to something that is going to create change within you. In the future, we will have emerging of the male and female on this planet that we've never known. Such things as commitment and responsibility and marriage will lose all their connotations because they will not be a factor. It will not be a force of resistance, but the recognition of souls that learn how to dance through each other. We are great mirrors of each other, great teachers to each other, and we can use that. It is our wont to dance. We love to mirror off each other. Let that mirroring become of the highest octave, so that as you look out of yourself, you see both the male and female in that other being. You see the wholeness of the other being, so that you can interact with understanding.

People choose just what they need every time. Every past life that they ever go into will be just what they need. If they need to be flashy in this lifetime, they'll get ten lifetimes of being the peon until they understand they don't need the glamour.

When people describe the unmanifest, they describe going home. They come into places where they experience what is within; where they do not experience separation.

When asked, "why did you separate?", they at that point all say the same thing: "to experience". We are all receiving, in that other 90% of our brains, the cues of reality and the cues of truth all the time. It's just that we don't know how to pay attention.

Our emotional bodies want us to see our higher self as a person, but the higher self comes in as a spinning wheel or a wind or a triangle. It will come in as some symbol, poking at some level of your consciousness, saying, "open this door". Inside yourself, on the other side of the door, you have an increment of meaning which you will then recognize on a soul level, and you will expand. If you meditate, and you are looking for your higher self and you get a spinning wheel or a triangle and you think you didn't get your higher self, don't worry. If you will, instead of trying to control it, allow yourself to just surrender into the essence of that symbol, you will be nourished. Your consciousness will change. Your brain will record. For example, if you ask the higher self a question and all you get is pink light, then you must know that the pink light is the trigger, the veil, through which you must pass in order to be able to perceive anything on the other side. The answer is there, but it's given to you from the perspective of the other side of the hologram.

People always seem to have the idea that we have to striggle for something. We have to fast, pray, give up, be good, etc. If one's attention is turned to the higher self and we become aware of the frequencies we're using, we can make a choice. You have a choice. It may not be easy. That's why we got into the ritual, going into caves, using equipment, doing all those things so we don't collapse our attention. Now we need to drop those rituals. We need to drop the things that are in the way of understanding; you don't have to put questions in a linear form. You simply move to the energy and recognize it. The energy will push back. We have to simply surrender and say, "guide me". That's all. The more we ask for it, the clearer it comes in. We're able to perceive the whole so that we ask, "should I do this or that?", the answer is there, and it's not yes or no, but it's within. All of us know each question has an increment of meaning, whereby the answer was within the question.

You are your higher self. There are few teachers outside ourselves. You cannot demonstrate and manifest the power that is needed on this planet until you can accept that the spiritual teacher is not outside yourself. It is within each one of you, and there are no excuses, and there are no handicaps. When people release lifetime after lifetime, they will clear this theme and start on another. Pretty soon they stop living their lifetimes on a specific planet. They find themselves in some other dimension or consciousness and let go, because they experience it multidimensionally.

If you really entertain the possibility that you are multidimensional beings, which you are, you will recognize that there are no wrong choices. You don't have to clutch. You can't take the wrong road. You can simply make a choice that will teach you this lesson or that one, each of which will bring you back to your center. When we experience the freedom, when we experience the surrender with that understanding and release judgement so that we move into unconditional love, we are going to manifest everything, so that we can be who we truly are.

Enlightenment is to be able to reach out and pull in information that expands our capacity. The second we expand who we think we are right now, we fall smack into past-life memories as well as other dimensional realities, because it's part of the coding that is in an identical infrastructure of our bodies. You have to let go of all your little stuff. The second we surrender and focus our attention and our intentionality, we can go anywhere we want.

Its the experiencing that changes the molecular structure of the body. People sometimes focus on a particular organ and then have the experience of disease of that organ. Only by letting go of the focus can it change.

When people go into soul experiences, they have no body. They are total light, they are everything, there is oneness. The soul becomes a concept of individuality. Experiences function as ways to recognize that you are not separate and you are whole. When entities have a body without a nervous system like humans, there is a whole different frame of reference. That's why galactics and other entities sometimes have no emotional response, which is why many galactic beings are really out of balance here on Earth. Their frame of reference does not include an emotional body as we know it.

It is a wonderful experience in relationships just to find yourself being angry and at the same time the giggle is going on because you know that it's just you playing. It happens simultaneously. Once we begin to have those kind of experiences, our attachment to the anger or to the self-righteousness or the positionality is simply erased.

One of the interesting things about past-life explorations is that it allows us a frame of reference for those with whom we've been sons and lovers and friends. We've known them before, so we can pick and choose how we're seeing them now. If part of somebody is falling off the ledge, you can say, "let me experience you on a soul level." And you can embrace that. The second that you consciously choose to reach in on that soul level, your tears will stop, because you'll know that it's useless. If someone wants to die as an alcoholic, it's OK, because all of that person isn't there. There's all the rest of their hologram. You can, through your conscious will, through your intentionality, merge with another part of them. This is creating reality. That is the experience of, or the translation of, what we mean when we say: "let go". How do you let go? The way you let go is by expanding your consciousness. That's the only way to let go. When the consciousness expands and you experience people on a soul level, perhaps even a different memory of them, what will happen is that the emotional body will lift up. The tears stop, the emotional body starts to breathe, starts to radiate out, and you make contact. The second you do that you are creating another reality, a reality of compassion.

It appears that the higher self divides past-life sessions into two main categories. The first category comes from people who initially explore their misuse of power. They plunge directly into all of the chopping and burning and intense experiences about which they are holding profound guilt or judgement. They go directly into the most dramatic aspects of those experiences and release those lifetimes first.

The other category comes from people who experience being "the victim" during their first series of lifetimes. The victim and the victimizer are one, and we don't need to attach ourselves to either of those polarities. The "good guy" appears to be a variation of the theme of the victim. Usually, the price of being the good guy is being the guy on the sidelines. These states relate to egos that may be in a state of fear. It also seems to relate to the level of resistance of the soul coming into these emotional octaves.

There is no good and evil. There are no victims. You are just experiencing this so that you understand permission and choice, so that you understand cosmic law.

Definitions Helpful to Thought Processes

The following definitions, also used elsewhere, were used by L.Ron Hubbard. Hubbard was one of the only ones who looked on to what was being done to humans, and contributed greatly to the human race.

Man - a body run by an awareness of awareness unit which has infinite survival power. A composite being of four distinct and divisible actualities: the thetan, the memory banks, the genetic entity, and the body.

Genetic Entity- The "mind" of an animal, a dog or a cat or a cow. That entity which is carrying along through time, that is making the body through the time stream. Also referred to as the GE.

Theta - thought, life force. The energy peculiar to life which acts upon material in a physical universe and animates it, mobilizes it and changes it. Thought is subject to alteration in character or vibration, at which time it becomes agitated. The three primary components are affinity, reality, and communication.

Thought - the perception of the present and the comparison of it to the perceptions and conclusions of the past in order to direct action in the immediate or distant future.

Prime Thought - the decision moving the original potential being from the state of not beingness to the state of beingness. A common name for this phenomenon is necessity level.

Time Track - The consecutive record of mental image pictures which accumulates through the individual's life; the time span of the individual from beingness to present time on which lies the sequence of events of his total existence. The time track produces a scene every 1/25 of a second; there is a time track for each perceptic, all tracks running simultaneously.

Engram - A mental image picture which is a recording of a time of physical pain and unconsciousness that has impact or injury as part of its content. An engram is also a complete recording of every perception present in a moment of partial or full unconsciousness. Biologically on the cellular level, an engram is reflected as a lasting memory trace on a cell. An engram is held at a specific point on the time track. The engram is not capable of being reached by the analytical mind.

Engramic Thought - Thought that demands immediate action without examination by the analytical mind.

Analytical Mind - the conscious aware mind which thinks, observes data, remembers it, and resolves problems; that mind which combines perceptions of the immediate environment, of the past (via pictures) and estimations of the future into conclusions which are based upon the perceived realities of situations. The analytical mind could be said to consist of visual pictures either of the past or the physical universe, monitored by, and presided over, by the knowingness of a thetan. The keynote of the analytical mind is awareness; one knows what one is concluding and what one is doing. The analytical mind is that part of the being which perceives.

Reactive Mind - Portion of the mind which works on a stimulus-response basis, which is not under conscious control, and which exerts force and the power of command over his awareness, purposes, thoughts, body and actions. Engrams are stored in the reactive mind, which is a product of thought filtered through the neurological quantum based structure of the brain. The reactive mind never stops operating, and acts below the level of consciousness in the human. It has been called the "unconscious" mind. The reactive mind is always conscious.

Hypnotism - an address to the reactive mind. It reduces self-determinism by interposing the commands of another below the analytical level of an individual's mind. Hypnotism materially aberrates human beings by keying in engrams which would otherwise lie dormant.

Game - any state of beingness wherein exist awareness, problems, havingness and freedom (separateness) each in some degree. A game consists of freedoms, barriers and purposes

Somatic Mind - the mind that works in purely stimulus-response way, contains only actingness, no thinkingness. The somatic mind is that mind which, when directed by the analytical or reactive mind, places solutions into effect on the physical level. It is the same mind which takes care of the automatic mechanisms of the body.

Total Power - occurs when an individual can selectively confront or not confront anything.

Marcab Confederacy - Various planets united into a very vast civilization which has come forward up through the last 200,000 years, formed out of the fragments of earlier civilizations. In the last 10,000 years they have gone on with a sort of decadent kicked-in-the-head civilization that contains automobiles, business suits, fedora hats, telephones and spaceships. A civilization which looks like almost an exact duplicate of the United States but is worse off.

Facsimile - All physical perceptions, all effort, emotion and thought experienced are recorded continuously. The recordings are called facsimiles; they are not dependent upon an organism for existence; an energy picture which can be viewed again. A facsimile contains more than 50 identified perceptions. It contains emotion and thought. A facsimile is also the physical universes's impression on thought, specifically that section of thought which has a physical universe impression with a time tag on it.

Facsimile Bank - contents of the reactive mind.

Theta Being - being that thinks without facsimilies. It can act without experience, and it knows simply by being.

Theta Clear - A person who operates exterior to a body without need of a body. A theta being which is cleared of its compulsion to have a body. A person who is at cause over his reactive bank and can create and uncreate it at will. An awareness of awareness unit which knows it's an awareness of awareness unit that can create energy at will, and can handle and control, erase or re-create an analytical or reactive mind.

Operating Thetan - a being who is exterior to a body that can have but doesn't have to have a body in order to control or operate thought, life, matter, energy, space and time (MEST); an individual who could operate totally independently of his body whether he had one or didn't have one.

Life Form - one of the products of thought (theta) vs matter, energy, space and time (MEST)

MEST Body- the physical body; a vessel for the theta being; an identification tag for a being. The body records actual wave emanations from the MEST universe. The thetan uses these recordings

Ridge - an energy focal point having location , caused by the coincidence of two or more energy flows. Ridges can impinge on each other and cause an enduring state. Ridges exist in suspension around a human, and are the foundation upon which facsimilies are built. Ridges can be described in terms of electronic density.

Entity - ridges on which facsimilies are planted. Each one can be a thinking entity. It thinks it's alive. It can think it's a being as long as energy is fed to it.

Sex - an interchange of condensed admiration particles which forwards new bodies into being.

Regret - Is what inverts the time track; one wishes it hadn't happened and tries to collapse the track on the point. Overt acts collapse the track.

Evil - that which inhibits or brings plus or minus randomness into the organism; a thing which does more destruction than construction is evil from the viewpoint of the individual, the future, group, species, life or MEST that it destroys.

Reality - the condition of reality is Is-ness.

Space - a viewpoint of dimension. Space is not nothingness.

Time - A postulate that space and particles will persist. Time exists in those things a thetan creates. A shift of particles, always making new space, at an agreed-upon rate. Considerations of time are mechanically tracked by the alteration of the position of the particles in space. Time is the coaction of particles. You cannot have action of particle at all unless you have space, and when you have a change in space then you have a different time.

Slavery - being positioned in another's time and space.

Invader Forces - electronic space societies on an evolutionary line which use heavy gravity planets that have set off to conquer the physical universe.

Implant- A painful and forceful means of overwhelming a being with artificial purpose or false concepts in a malicious attempt to control and suppress the being.

Implant Goal - A goal induced in the thetan by overwhelming force or persuasion.

Implant GPM- Implanted Goal Problem Mass - an electronic means of overwhelming the thetan using the mechanics of the actual pattern of living to entrap the thetan and force obedience to behavior patterns.

Individual - a finite composite of facsimilies. Individuality depends upon facsimilies.

Psychosis- inability to be; inability to assign time and space.

Fifth Invader Force - a thetan from the 5th invader force believes himself to be a very strange insect-like creature with horrible hands. He believes himself to be occupying such a body, but is in actuality simply a unit capable of producing MEST.

Perception - the process of recording data from the physical universe and storing it as a theta facsimile.

Engram Command - any phrase contained in an engram.

Worry - contradictory engram commands which cannot be computed.

Self-Confidence - belief in one's ability to decide and in one's decisions.

Group Reactive Mind - the reactive mind composed of the composite engrams of the group itself.

Group Theta - the ideas, ideals, rationale and ethics of a group. The group theta is an actual force. Cultures are like accumulated souls which flows over a number of individuals and persists after death of those individuals via other individuals or groups.

Enforced Reality - the demand on the individual that he experience or admit reality when he has not felt it. Any time a person is made to agree by force or threat or deprivation, to another's reality and yet does not feel that reality himself, an aberrative condition exists.

"One with the Universe" - one of the control mechanisms used on thetans. This is untrue. Thetans are individuals and do not merge with others as they rise up the scale.

Attention Unit - a theta energy quantity of awareness existing in the mind in varying quantity from person to person. Energy flows of small wavelength and definite frequency.

Awareness - the ability to perceive the existence of. Awareness itself is perception.

Awareness of Awareness Unit- the individual himself. An actuality of no mass, no wavelength, no position in space or relation in time, but with the quality of creating or destroying mass or energy, locating itself or creating space, and of re-relating time. The Thetan.

Theta Trap - traps that use electronic force to knock the theta into forgetting, into unknowingness.

Theta Perception - that which perceives by radiating towards an object and from the reflection preceiving various characteristics of the object. Theta perception is dependent upon willingness to handle and to create space, energy, and objects in view of the fact that the mass-energy-space-time (MEST) universe can be established easily to be an illusion.

Theta Exterior - a being who knows he is a spirit with a body and not just a body. A thetan who is clear of the body and knows it but is not yet stable outside,

Games Condition- when an individual's power of choice has been subjugated against his will into a fixated activity from which he must not take his attention; it is a condition of aberrated reactive activity.

Immortality - infinite survival. Life survives through the persistence of theta. A species survives through the persistence of life in it. A culture survives through the persistence of the species using it. The theta of an individual may survive as a personal entity throughout many lives.

Implant Goal Problem Mass (Implant GPM) - An electronic means of overwhelming the thetan with a significance using the mechanics of the actual pattern of living to entrap the thetan and force obedience to certain behavior patterns

Implanted Goal - a goal which has been induced by overwhelming force or persuasion.

Individual- a collection of memories. The composite of all his facsimiles plus his impulse to be.

Mind - pictures which have been made of experiences and plotted against time and preserved in energy and mass in the vicinity of the being and which when restimulated are re-created without his analytical awareness. A communication and control system between

the thetan and his environment. A natively self-determined computer which poses, observes and resolves problems to accomplish survival. It will not permit itself to become overloaded so long as it can retain partial awareness of itself. The mind is composed of energy which exists in space and which condenses down into masses.

Organism - a portion of mass-energy-space and time which has been organized and is being controlled by theta.

Esoteric History Some Notes

Long ago in the sector humans recognize as M-45, near the Pleiades cluster in Lyrae, there was evidently a large empire which destroyed itself through a series of wars. The Lyran wars lasted for over 3,000 years. Several peaceful factions who perceived the outcome departed for free zones in neighboring clusters after the war which destroyed their home world. The negative species migrated to the stars in Orion.

Before the war, the golden race of beings represented the major gene pool of the galaxy.

The warring Lyrans who survived as forms incurred chromosome damage, which caused development of stunted sexless bodies - the lot of the Rigelians. Their bodies are distorted and evidently require special environments. They have one lung and no sex organs. In addition, what became the Rigelians suffered negative psychological and spiritual damage. Radiation causes insanity in these beings.

As soon as the Orion group reconstituted their power base they launched attacks on the Procyonians using beam weaponry and nuclear devices. Although the Procyonians had escaped the genetic damages that overcame what humans now know as Greys, the Orion attacks did cause some damage to their genetics and decimated their numbers.

The conflict between the 'blonds' and the 'greys' is still an active one. Procyon and Rigel currently have a loose truce. Conflicts between Rigel and the Sirians, who view Earth as belonging to them (as do the reptilian Draconians, who left the Greys 'in charge' when they left) are still active.

Earth was originally colonized and seeded by the original blond Lyrans thousands of years before the great civil war began.

**The Theory of Longterm Planetary Management
by Suppressive Entities**

One of the most outstanding theories or scenarios having to do with this subject involves a group of several entities who function according to Service to Self. These entities have influenced the planet Earth for over 75 million years.

One of the beings has been termed Xenu. Xenu is an ancient suppressive being who has done the most damage to entities in this sector. All the entities involved in this scenario continuously take a succession of physical bodies in order to directly influence planetary events. Xenu (pronounced Zen-u) reigned on Earth some 75 million years ago. During his reign of terror, many crimes worse than those of Adolph Hitler were perpetrated. He derived the original system-wide implant which effectively traps souls and cripples the spirit of beings in this sector. Xenu's last action was to set nuclear genocide in motion on Earth. This is the main source of the term "Wall of Fire", which is associated with this nuclear catastrophe.

Xenu had a three-phase plan that included (1) slaughter of opposing factions, (2) destruction of defenses on every planet in the system, and (3) removal of all minority/unwanted populations and their extermination. This included the entire population of the Earth. The plan was carried out with the help of criminals, renegades, and a fully-controlled police state. Several entities escaped physical assassination and exposed the true intent of Xenu and his co-conspirators. Xenu and his group had covered their true intentions by claiming that groups of criminals and saboteurs had been responsible for the assassination and destruction carried out in the first two phases. The third phase was covered by "scientifically backed-up" insistence of police state officials and that all the crime was because of "overpopulation", the "state of emergency" existing, etc. The government had the "right" to use martial law and police-state tactics to "relocate the populations". After Xenu and his co-conspirators were exposed, loyal citizens were able to overthrow the police state and re-establish a more appropriate form of government. Xenu and his closest conspirators were captured and brought to trial on charges of:

- (1) High Treason
- (2) Willful and malicious mass murder
- (3) Mass implantation of beings
- (4) Conspiracy to institute a police state

Various Markabian forms of leverage were instituted on the population during the period before Xenu and his co-conspirators were overthrown this were:

- (1) Institution of a personal income tax
- (2) Enforced identification
- (3) Violation of privacy without consent

The group of suppressive beings were found guilty as charged and were sentenced to be exhibited to the peoples of each planet so that they would be recognized as the perpetrators. They would be confined inside a mountain with life support that would sustain them for eons. The body life-support and electronic barrier field (designed to keep the beings from escaping) were designed to be self-powered for 70 million years. After this time had elapsed, Xenu and his conspirators escaped and took bodies in the Markab system. The Markab system had already achieved a society that was close to their implant-controlled method of government. Xenu then worked out a covert plan to take over Earth for Markab by the time it would be nearly ready for acceptance into the Galactic community.

It was for this reason that Xenu and his top henchmen appeared on Earth in the 18th century in Europe. Xenu took the body of Adam Weishaupt and created the society known as the "Illuminati". Its "Earth" purpose was to take over political control from the Catholic Church and the Kings of Europe.

In the 19th century, Xenu carried on his plan by taking bodies in the Rothschild banking family. The infiltration and take-over of secret societies such as the Masons, a continuing part of his plan to gain "inside" control, was also accomplished.

In the 20th century, he and his co-conspirators influenced the exact points of monetary and political power to bring their world domination plan to its conclusion. Xenu controlled the body of FDR, the American president, in the 1940's and planned for the use and control of atomic and nuclear weapons to keep the populations of Earth in fear and terror. He also "gave away" several formerly free countries to the Soviet Union in 1945. His orders to use the atomic bomb on Japan (despite the fact that Japan had proposed surrender since March 1945) were carried out by Truman.

Discarding the body of FDR, Xenu then inhabited the body of an economist named Jacobsson in Basel, Switzerland. Jacobsson controlled the Bank of International Settlements. This bank was set up in 1930's to control international finance. It is the Markabian "hard base" for control on Earth, and is totally free of taxation and governmental control. By Swiss law, it is not even part of Switzerland.

From 1956 to 1963, Xenu (as Jacobsson) was Director of the International Monetary Fund. In this position he gained control of the American and Third World monetary lines. Xenu is still known to "insiders" as Herr J, but he has taken a new name of Strasborg. His body is now that of an old man of 90 who walks with canes and is crippled on the right side, which is an affection that Xenu's bodies are prone to.

In 1984, Xenu took the body of the advisor to the President of the European Parliament.

Characteristics of Control Used by Xenu and his Co-conspirators

Ideas of government include personal income tax, identity cards, credit records, fingerprinting and passports. His methods typically include revolts that "start covertly from the top", creation of imaginary enemies to justify creation of police states, use of psychiatry as a tool of political control, and use of drugs, mind control, and implants. Ideas of "overpopulation", "crime waves", "possible revolt" are used to justify police and psychiatric actions. Uses declaration of "martial law" to gain complete control.

Effective Measures to Use Against Markabian-type Control

Measures include intentions to reduce governmental control, reduction of tax, more personal freedoms, and less control over individuals.

Note: Compare this type of information to the information starting on page 374A. There are indications in recorded history that entities have in fact maintained overall control of human beings - this may support the above material.

Researcher Finds Evidence of Nuclear Exchange in Pakistan 4,000 years ago

A British research, David Davenport, recently completed 12 years of research traveling and studying ancient Hindu scripts and evidence at a site where a great city, called Mohenjo-Daro, once stood. There is evidence that this ancient heavily populated city in Pakistan was instantly destroyed 2,000 years before Christ by an incredible explosion that could have only been caused by a nuclear device.

What was found at Mohenjo-Daro corresponds exactly to what was found at Nagasaki. There was an epicenter about 50 yards wide where everything was crystallized, fused, or melted. Sixty yards from the center, bricks are melted on one side. The mysterious event was recorded in an old Hindu manuscript called the Mahabharata:

" White smoke that was a thousand times brighter than the sun rose in infinite brilliance and reduced the city to ashes. Water boiled...horses and war chariots were burned by the thousands...the corpses were mutilated by the heat so that they no longer looked like human beings. Never before have we seen such a weapon."

Based on his study of many ancient manuscripts, Davenport believes that the end of Mohenjo-Daro was tied to a state of war between the *Aryans* and the Mongols. Davenport believes he has found evidence which indicates that the Aryans controlled regions where *space aliens were mining minerals* and exploiting other resources. Because it was a Mongol city, the aliens agreed to destroy Mohenjo-Daro on behalf of the Aryans. According to Davenport, it appears that the aliens needed the friendship of the Aryan kings so that they could continue their prospecting and research. The ancient texts tell us that the 30,000 residents of the city were given seven days to leave - a clear warning that everything was about to be destroyed. Some people did not heed the warning. In 1927, 44 human skeletons were found shortly after the city was discovered. All the skeletons were flattened to the ground, face down. The ancient texts also refer to the "vimans", or flying craft, which the aliens used to go from place to place.

Davenport has recently published these findings and others in a book entitled:

"2,000 Years Before Christ - Atomic Destruction"

William Sturm, assistant director of the Applied Physics Division of the Argonne National Laboratory in Chicago, agreed that "the melting of the bricks was not caused by a normal fire".

Some Elements in History that Support Interaction
with Non-Human Entities, their Civilizations, and
Technology

1. Bolivian legends that go back some 5,000 years tell of the destruction of civilization in far-off times as the result of a conflict with some non-human race "whose blood was not red like ours".
2. According to the pictographic writings of Tiahuanaco, in the age of giant tapirs, a race of man-like beings of high intelligence but with webbed feet and a different kind of blood came from another planet and settled on the highest lake on Earth.
3. Beltran Garcia wrote a history of the Incas. According to Garcia, in the Tertiary era (5 million years ago), a space ship which glittered like gold landed on the island of the sun at Lake Titicaca. From this ship came a female creature having breasts like a human woman but a conical head, huge ears, and webbed hands with four fingers.
4. Plato tells us that the first Atlanteans were of a different race and blood from the other inhabitants of the Earth, and in 1960 a group of Soviet scholars suggested that they may have been men of bluish color. (Also see the figures in the Baghavat Gita for other examples of humanoids with bluish skin).
5. In Guatemala, Mexico, Columbia, Peru and Bolivia we find legends of non-human races, their wars and their rule over others. They are described variously as blue men or men with round, flat or pointed heads. It is curious that references to them also occur in places far distant from those in which they are principally remembered.
6. Skeletons having flat heads have been found in Venezuela. Huge monuments to men with pointed heads suggests that their makers might have enjoyed modes of perception unknown to humans.
7. There are pre-Incaic beliefs that the stars were inhabited and that the Earth was visited by divine beings from the Pleiades.
8. The Peruvian Indians say that thousands of years ago their ancestors traveled on great golden discs which were kept airborne by means of sound vibrations at a certain pitch.
9. There are many legends about the building of the city of Tiahuanaco, which is 450 miles south-east of Nazca and 15 miles south-east of Lake Titicaca. According to Inca mythology, it was built in a single night by men who survived the Flood. An older legend says that it was built by giants that did not build the city of their own free will but were made to do so by beings who came from the sky. This former seaport was thrust

up to a height of 12,500 feet by the cosmic disaster of 10,000 years ago. Careful research by engineer Arthur Posnansky does indicate that the last city of Tiahuanaco was built some 16,000 years ago. Some other scholars put the city's age at 250,000 years. This may be possible inasmuch as several successive cities may have been built on the same site.

10. The United States archaeologist Hyatt Verrill spent 30 years investigating the lost civilizations of Central and South America. He described a pre-Incaic city protected by a rocky area which could only be crossed by a bridge constructed of ionized matter which could be made to appear and disappear at will.
11. In the 15th century it was reported by Spanish explorers who visited the westward Canary islands that a race of white-skinned, blue-eyed, fair-haired beings existed. These beings used a bird-like whistling language in which they were able to communicate over long distances - an art still practiced by inhabitants of the Canaries. Greek historian Plutarch refers to the people of the Canaries as Atlanteans. Homer may have identified the island with Elysium (the first two letters of Elysium are EL - descendants of the EL's?). There were also a people called the Atlans who were from space.
12. Many pre-Colombian peoples used a calendar based on the time taken respectively by the Earth and Venus to revolve around the Sun, the ratio of the periods being 13:8 (i.e. Venus completes its orbit 13 times in 8 Earth years). The use of a Venusian calendar is remarkable, because it requires a great deal more astronomical knowledge to observe its revolutions than those of Earth's moon.
13. In the Sanskrit text known as the Samara Sutradhara, we find mention of the use of two biological weapons, each of which produced its own results - the Samhara debilitated its victims by attacking the motor center of the brain, and the Moha caused blockage of nerve impulses, resulting in complete paralysis. In the Chinese Feng-shen-veni-i, we find similar descriptions of germ warfare, and again reference is made to specific weapons causing specific results.
14. Carvings at Lussac-les-Chateaux dug up in 1937 show that men, women and children were wearing hats, shoes, trousers, and skirts 15,000 years ago.
15. The Smithsonian Institution and the Bureau of Standards in Washington have brought to light various objects that prove that 7,000 years ago, people were producing steel in furnaces at a temperature of 9,000 degrees Centigrade.

16. There is evidence that Chinese metallurgists extracted aluminum from bauxite 1,600 years ago. The modern method was rediscovered in 1808.
17. In 1959, a Soviet mission visited Tibetan monasteries and were presented with the opportunity to undergo mental training. They performed an experiment in mental focus at the great monastery of Galden with a lama where a cloudy image came into view. The image was of a creature somewhat like a man, but with features and jointed limbs like those of an insect or crustacean. In front of the creature was a moving reproduction of the solar system, except that there were ten planets instead of nine. There was an additional planet beyond Pluto. The lama refused to say where the images were coming from, but told the scientists that indeed there was a 10th planet beyond Pluto.
18. In 1725, the French explorer Father Duparc discovered the ruins of the Hsing Nu capital that was destroyed by the Chinese many centuries before. Within the city, Duparc found over 100 monoliths which had been covered with silver. He also discovered a three-storied pyramid and a moonstone covered with bas reliefs of unknown plants and flowers.
19. The American Apache Indians tell stories of tunnels between their lands and the city of Tiahuanaco, and claim that their ancestors traveled for years by this route. The Indian chiefs also assured that the tunnels were "carved out by rays that destroy the living rock" and that their creators were "beings that live near the stars".
20. According to Ossendowski, the kingdom known as Agharta was founded over 600,000 years ago. The references in literature to Agharta, space-flights and superhuman powers are so frequent and correspond so closely with Sanscrit texts that scientists consider it worth close study.
21. Professor Komatsu Kitamura in Japan, upon researching the legendary Kappas said to have inhabited Japan in the 11th century, discovered that they were described as web-footed bipeds with three hooked fingers on each hand, the center digit being longer than the others. Their skin was brown, smooth and silky. Their heads were elongated; they had large ears and eyes of a triangular shape; the nose was like a proboscis and they had a casket-shaped hump on their backs. Tales of the Kappas speak of their vehicles, which could move swiftly through the waters or through the heavens.

22. Some decades ago, a map of the sky was found in a cave at Bohistan in the Himalaya foothills. Astronomers confirmed that it showed the correct position of the stars 13,000 years ago. On the map there were lines connecting Earth and Venus.
23. Many Central Asian legends relate to the Gobi Desert as being a great sea in remote times. According to Chinese sages, there was an island in this sea that was inhabited by "white men with blue eyes and fair hair", who "descended from heaven" and imparted the arts of civilization to their fellow men, including the inhabitants of Mu, who attained a high degree of culture some 75,000 years ago. It is said that these men came from the "great white star" (Venus?).
24. Scientists reconstructing the geography of Mu have come to realize that the empire arose 150,000 years ago and reached its peak 75,000 years ago.
25. Research has demonstrated that some 30,000 years ago a highly developed civilization existed in the Andes, and also that the Earth's moon was not there at that time. This supports the evidence that suggests that the Earth's moon is not a natural satellite but is an artificial construction parked there some thousands of years ago.
26. The bones of human creatures over ten feet tall have been found in south-eastern China. According to paleontologist Pei Wen-chung, these bones are over 300,000 years old. At Agadir in Morocco, hunting weapons of a large size were found that indicate its user to be at least 13 feet tall.
27. A human skeleton 17 feet tall was discovered at Gargayan in the Philippines.
28. Creatures definable as Homo Sapiens existed in Africa some 500,000 years ago. There is evidence to justify pushing this date even farther back.
29. According to researchers, the stage at which each of the five main races developed from ape-men into human beings occurred 250,000 years ago. Brain capacity jumps from 700cc to 1,600 cc.

**Psycho-Social Study of Human Conflict
Reveals Alien Influence on Humans**

The reality of alien interaction with humans can be seen throughout history. In the 1st century, the Roman statesman Cicero wrote of strange spheres in the sky. There are records dating back to 8th century France that tell of individuals during Charlemagne's time that were taken up by strange craft and shown various marvels. At that time, if they revealed what had happened to them or if it became public knowledge, they were killed. There are even records during that time which speak of strange aerial ships destroying crops.

All the major religions of Mesopotamia, Egypt and the Americas are dominated by adoration of "Gods from the sky". There is evidence that these custodial rulers from the stars controlled every aspect of human society from the initial appearance of the current version of Homo Sapiens about 30,000 years ago. It was at the same time that the Neanderthal version of Homo Sapiens mysteriously and suddenly vanished from the face of the planet.

Early investigations into this matter were done by Charles Fort, who lived between 1867 and 1932. He found that extraterrestrial societies were very much involved in Earth's prehistory, and that the status of the human race appeared to be like self-satisfied livestock. His final thought was that humans were used as slaves.

The idea of humans as a slave race is not new. Ancient Sumerian records dating back to 4500BC relate that humanoids from the sky were the rulers of humans. Human priests acted as intermediaries between the rulers from the sky and the human masses. The rulers from the sky were described in those records as having male and female sexes, racially diverse, and behaviorally similar to humans.

The records of that time also relate that it was the general Sumerian belief that the first humans were bred in the wombs of alien females. Sumerian records indicate that the alien rulers were involved in mining and other exploitation of natural resources that involved humans performing lifetimes of backbreaking labor. The actual creation of the Homo Sapiens species occurred sometime between 300,000 to 500,000 years ago.

Records in ancient Mesopotamia credit an alien by the name of Ea for directing the creation of Homo Sapiens as a genetic hybrid. Ea was also known as the Prince of Earth. Other portions of the Earth were controlled by Ea's half-brother. During the time of his uninterrupted influence, marshes by the Persian Gulf were drained and dams and dikes were constructed. Ea was the main advocate of the hybrid species later known as Homo Sapiens before the council of aliens that managed operations on the planet.

Sumerian records indicate that human beings were spiritual beings animating physical bodies, and that the alien rulers contrived an original plan to keep entities attached to physical bodies, body physically and psychologically, so that the humans could function as slave labor. Population control measures were carried out on the humans. Food supplies were cut off, humans were forced to cannibalism, diseases were introduced, and there was global flooding.

In order to prevent the humans from banding together and realizing the predicament they were in, the aliens sought to block spiritual recovery for the humans. Various immediate measures were taken in order to prevent human unity. Formal religions were introduced, people were scattered around the planet, and different language functions introduced. The aliens made sure that existence for humans became a physical chore that would preclude excess time on their hands.

Ea, when in power, was dedicated to the dissemination of spiritual knowledge to the newly created human hybrids. He was aware of the desire by other alien groups to promote human bondage. Despite his good intentions, Ea failed to maintain the freedom of the human species. His faction, sometimes known as the Brotherhood of the Snake, was defeated by other alien factions. Ea was banished to Earth by the other aliens, and his title was changed from the Prince of Earth to the Prince of Darkness. He was then portrayed to the humans as the "enemy of a Supreme Being" and the humans were told that all their troubles were the fault of Ea. Humans were subsequently programmed to detect any trace of Ea in future lifetimes.

Under negative alien influence, the Brotherhood of the Snake was changed from a force disseminating scientific and spiritual knowledge to one that became known for spiritual repression and betrayal. Corruption of the Brotherhood was evident in Egypt by 2000BC. The Pharaohs and priests were indoctrinated into the Brotherhood as Elite who would manipulate the masses for their own ends. Brotherhood functions in society eventually evolved into the Mystery Schools, which twisted spiritual knowledge, and restricted public access to any truths which had survived. Traditions were started that transferred knowledge orally and also embedded it in symbology which only the Elite could understand.

Monotheism was one of the most insidious teachings of the Brotherhood. It was started in Egypt during the reign of Akhnaton, and eventually evolved into the teachings embodied in Judaism, Islam and Christianity. Humans were taught that the aliens were Gods, and the aliens enforced human obedience. One group of alien custodians was named the Jehovah, who had influence over the Hebrew peoples. The Hebrews were befriended and ruled by the Jehovah, who typically landed his craft in the mountains. In order to promote the "God" concept, only specific humans were allowed to approach the Jehovah, which were presented to the humans as a succession of singular beings, named Jehovah, over a long period of time.

Over time, a network of Brotherhood organizations imposed alien institutions on the human species and generated conflict and war in order to manipulate and divide the human race.

Brotherhood influence in India was embodied in 1500BC when the faction known as the Aryans (who supported alien aims) invaded the area. The Aryans were a non-semitic white-skinned race that established a system of religious-feudal religion that became known as Hinduism. During this time the aliens traveled openly in ships with humans, engaged in warfare with other alien factions (which involved the use of nuclear and beam weaponry). It was described at the time that some of the aliens had blue skin. The aliens then imposed the caste systems, further confusing and dividing the humans in the area. The Hindu religion introduced the concept of "reincarnation" and the principle of "obedience bringing advancement".

Due to the influence of the custodial aliens, a succession of maverick religions began to spring up. These religious concepts attracted millions of adherents and basically consisted of six "systems of salvation", mixing truth and manipulative concepts.

The first "system of salvation" (hereafter SOS) was Samkya, which was introduced about 500BC. It taught that Souls were infinite in number, consisted of pure intelligence, were independent, incapable of change, and bound in matter. The system taught humans the concept that "suffering" was the result of "bondage to matter" and lack of knowledge.

The second SOS was Yoga. The third was Mimamsa, which was an attempt to maintain Aryan creeds. The conflict in Mamamsa was between the ideas of rigid obedience to doctrine versus spiritual freedom. Buddhism was the fourth SOS. It was founded about 525BC. It opposed the caste system of Hindism, but added new and more insidious elements to human lives. Buddhism taught that "freedom will come some day". One of the most influential teachings of Buddhism was what became known as the Mettaya Prophecy.

The Mettaya Prophecy said that an individual with great knowledge and ability "will arrive some day to save the human race". This eventually evolved into the various "End of the World" doctrines, which became known in the concepts of Day of Judgment, Final Battle, Armageddon, and Messiah From God (750BC). One of the most influential people in this area was Zoroaster, who disseminated the Mettaya concepts together with Monotheism. This had a catastrophic effect on human society.

The ideas and concepts injected by the being known as Jesus deteriorated very quickly due to custodial influence, and in 325AD the Council of Nicea began defining and interpreting religious concepts having to do with the Jesus Ministry. Thus, what began as an attempt by an advanced being deteriorated into the fifth SOS. The Nicene Creed redefined the entity Jesus as the "son of God", and banned the concept of pre-existence of human beings in other lives.

The introduction of the concept of "sex as sin" produced devastating effects on the humans. It mentally tied them to anxiety and frustration about natural processes and furthered human focus on the body. In modern times, this is seen as a component of a whole system of ego defense mechanisms embodying security, sensation, and power that today create a feeling of powerlessness and dependency in human beings. It also promotes the "wheel of fortune" mentality that blinds humans to the truth of their own capabilities and nature.

The sixth SOS was promoted by Mohammed in 570 AD, who had a mission in life that was triggered by the appearance of an apparition. It taught that Allah is the Supreme Being, brought in the concept of "fire and brimstone" as embodied in the Koran, and was a custodial religion centered around "obedience". The Koran also promotes the Mettaya ideas, and what became Islam eventually became the source for a series of holy wars and crusades. Here the Brotherhood concept of assassinations was introduced. It eventually evolved into the "lone assassin" concept used by the CIA and other extensions of the Brotherhood to mask their involvement in the manipulation of the populace.

Alien custodial religious programming embodied the following main concepts to confuse the human population:

1. Sources of teachings were said to be a "God or force."
2. Belief in a "single Supreme Being."
3. Belief in "physical immortality.". See Mormon belief system)
4. Belief and adherence to "doctrine."
5. Belief in "severe punishment to backsliders/non-believers."
6. Belief that "reincarnation is part of a spiritual plan."
7. Belief that "higher forces control human destiny."
8. Belief that "one Supreme Being created the universe."
9. Belief that "human suffering is part of a broader plan."
10. Belief that "spiritual recovery" or "salvation" is "upon the Grace of God".

Population Control

The creation of the mentality that produces chemical and biological weapons owes its source to alien influence. The appearance of global disease is also there. Between 540AD and 592AD the bubonic plague ravaged the East Roman Empire. Records show frequent aerial phenomena in conjunction with outbreaks. Very often, plagues would be preceded by mysterious foul smelling mists, humanoids dressed in black, and "comets" in the sky. A small list of plagues that were preceded by the above events:

<u>Year</u>	<u>Description</u>
1298-1314	Large "comets" seen over Europe
1333	Plague commenced after a vile mist appeared
1347	Plague epidemic in Europe. 40 million dead in 4 years.

Note: This scenario happened every 10-20 years until the 1700's, resulting in the death of over 100 million people.

1500-1543	26 "comets" recorded
1556-1597	15 "comets" recorded
1568	"comet" preceded plague in Vienna
1582	"comet" preceded plague
1618	9 "comets" recorded
1606	"comet" preceded general worldwide plague

Through recorded history, there are also references to humanoids dressed in black. Their presence would signal an almost immediate outbreak of the plague. In 1559 men dressed in black were seen spraying an oat field just before an outbreak of the plague in Brandenburg, Germany.

During the plague years, there was tremendous ethical decay among humans. There was attempt by various religious factions to eliminate others. There was an attempt by the Christians to eliminate the Jews. There was more genocide during this period than during the second world war. Genocides during this period were often incited by German trade guilds, who were Brotherhood organizations. The effect of the plagues was:

Plague + Inquisition + Genocide = Religious Apocalyptic
Prophecy Fulfilled.

The Bavarian Illuminati and the Rosencrucians were behind many of the new movements which appeared at this time. One of the earliest movements was the "Friends of God" that appeared in 1347, which is the same year that the black death struck Europe. It introduced a nine-step program designed to have humans be "obedient to God". The teachings were apocalyptic and secured a lot of converts. Eventually, the movement evolved into the Reformation of Martin Luther.

Destruction of Records and Knowledge of the Past to Isolate humans

There are many records which indicate that Brotherhood forces destroyed the library at Alexandria, which contained records dating back almost ten thousand years. Early Christian missionaries destroyed all records relating to religions in the early Americas. A standing order of the Brotherhood was to limit the perception and knowledge of the human species to a narrowly defined limit.

The Mayans

Mayan beliefs and legends tell an interesting story about the "creation of man". It tells that mankind (humans) were created to be the "servants of the Gods". These "Gods" made "figures of wood" before they made humans. These figures of wood "had no souls". They were bodies animated with no spiritual beings inside. The Gods thus produced creatures to which spiritual beings could be attached. The first humans, according to the Mayans, were too intelligent and had too many abilities, so the "Gods" reduced the intelligence and vision of the humans.

Calvinism

John Calvin was an important leader in the Reformation. In 1536 he wrote his first religious tract in Basel, Switzerland. According to Luther, "salvation" requires an act of belief. According to Calvin, "salvation" is "determined by God."

Calvin promoted the idea of pre-destination, and introduced the idea that some humans were "favored by God before birth" and were "the Elect", who had a "duty to suppress sins of the others" as a "service to God". According to Calvin, the "original sin" was the attempt to gain knowledge of ethics and immortality. From these concepts arose the idea that "war must be a necessary step to spiritual salvation."

Mormonism

Mormon beliefs are quite outspoken about custodial intentions on earth. Mormons believe that humans are immortal spirit bodies and that the object is to "dwell in a perfect immortal human body". Mormon teachings encourage the idea of endless entrapment in human bodies. Through these tenets, spiritual memory is dimmed and ethical questions remain unresolved. In this system, wars are seen as "Gods' tool of control".

Marxism

The Marxist philosophy follows alien custodial patterns. The philosophy is strongly apocalyptic and describes a "final battle" followed by a "utopia". In this system, spirit is a product of physical and material phenomena. The teachings of Marx promote the custodial aim of entity entrapment.

Nazism

Perhaps one of the largest, most influential movements of the Brotherhood, Nazism subscribed to the ideas of the Aryan movement, destruction of all beings not like themselves, and absolute power, domination and control over the planet. There is evidence that the Germans made several agreements with different alien factions during the life of Nazism. Post WWII activities of this faction includes creation of the CIA, Interpol, and the Federal Reserve System which, oddly enough, was also embodied in the Communist Manifesto.

Brotherhood Symbols

Common symbols that are characteristic of Brotherhood involvement are:

1. Swastika
2. Phoenix
3. Snake or Serpent
4. Eye of Horus/ All-Seeing Eye/ Masons/Seal of USA
5. Money Systems

Inflatable Currency System as a System of Control and Manipulation

Eventually, elite world power structures were assumed by the financial monetary and banking system. In the 16th thru 18th centuries, the money system was the key element in wars and revolutions. The true purpose of money is to represent the existence of actual tradable commodities. The introduction of the inflatable paper money system started in Holland in 1609.

Banking is socially and economically destabilizing. It is a source of wealth and power to the Elite who create the money supply. Through the system of inflatable paper currency:

1. People eventually become impoverished.
2. Notes are issued in excess of the asset base.

3. The struggle for physical existence is made more difficult.
4. Steady inflation reduces the value of money so that accumulated wealth is eroded.
5. Creates massive debt and parasitic absorption of wealth.

Custodial/Brotherhood Methods of Control

1. Genocide
2. Novel forms of killing and warfare
 - a. AIDS and Genetic products of death.
 - b. Chemical warfare
 - c. Implants and Electronic manipulation and Control
 - d. Mind Control programs. CIA/MKDELTA/MKULTRA
3. Creation of human conflict to weaken and delude species.
4. "Lone Assassin" management of targets of elimination.

Nature of the "Supreme Being"

The true nature of the "Supreme Being" is that there is no "Supreme Being". All spiritual beings are units of awareness of the intelligent conscious matrix that underlies everything. It is in this way that undifferentiated potential can undergo maximum differentiation; it provides for the maximum creation effort and evolution of consciousness. There is creation from more than one perspective or viewpoint.



"Harris Provides A Way To Make My Contribution To Medicine!"



"Harris provides a great way for me to contribute to medical research while studying pre-med at the University".

When meeting living expenses get tough, put your good health to work! If you are healthy and at least 19 years of age, join the thousands of people each year who help evaluate various medications. These medications may be new or currently on the market. Some you may have used in your own home.

EARN \$200.00 to \$2,400.00 Per Study!

- Each study includes a free physical
- Each study is fully explained.
- Each study is medically supervised.

HARRIS LABORATORIES

"Striving To Improve The Quality Of Life"

474-0627

621 Rose Street • Lincoln, NE 68502

Check Our Current Study Listing's Ad In The Sun. & Wed. Journal/Star.



Daily Nebraskan

Thursday, February 22, 1990

**PEOPLE SHOULD NOT
BE TREATED
LIKE CATTLE,**

*Collyer
Bullshit*

**AND PERHAPS
EVEN CATTLE
SHOULD NOT BE
TREATED LIKE
CATTLE.**



© 1989 by the author

Scientists Produce Genetically Engineered Calves

The following story was reported by Associated Press in June 1990:

" Scientists have produced a calf with a *human hormone gene* and three others with extra cattle genes, in research that could lead to leaner beef and cows that give more milk. The three bulls and one heifer were given the extra genes while still embryos as part of a continuing project at the Diamond G Ranch in southeast Texas. In addition, 60 to 70 cows at the ranch are pregnant with genetically altered embryos.

"I'm not willing to say any of the animals we have produced or those we're about to produce will have commercial value," said Ken Bondioli, a senior scientist at Granada Biosciences of Houston. "This is research in its infancy. There's a lot of potential there. We don't think we have all the answers."

The *human gene* is carried by the eldest of Granada's experimental cattle, a 15-month-old bull, researchers said. The animal has not grown as large as anticipated, but they still hope the gene altering could lead to strong, healthy cattle without the use of steroids. Steroids have been linked to heart disease and impotence.

"The purpose of these kinds of things is to prevent disease, make animals more immune to particular kinds of diseases," said David Eller, Granada's chairman. "In the broad analysis, it's to make food-producing animals more economical for producers to grow and more healthy for the diet-conscious, health-conscious consumers of today."

Researchers have experimented successfully with gene altering in chickens, pigs, sheep, and laboratory animals. *Human genes have also previously been inserted into farm animals.*

Funding for Development of the AIDS Virus

The development of the AIDS virus was funded in 1969 (three years before the request for development by the World Health Organization) through funds obtained by the United States Defense Department. The Defense Department requested and received \$10 million via House Bill 15090, which was reviewed in Hearings before the Subcommittee of the Committee on Appropriations, House of Representatives during the Ninety-First Congress in review of the Defense Appropriations for 1970.

Part Five of H.B. 15090 was entitled RESEARCH, DEVELOPMENT, TEST, AND EVALUATION, sponsored by the Department of the Army, the Advanced Research Project Agency (now DARPA), and Defense Research and Engineering.

The Feasibility program and laboratories were to have been completed by 1974-1975 and the virus between 1974-1979. The WHO started to inject AIDS-laced smallpox vaccine (Vaccina) into over 100 million Africans in 1977. Over 2000 young white male homosexuals (Operation Trojan Horse) were injected with laced Hepatitis B vaccine in 1978 through the Centers for Disease Control and the New York Blood Center. The development of the virus apparently had a dual purpose: (1) As a political/ethnic weapon to be used against black individuals and (2) one of the programmed efforts at de-population.

The session of the Subcommittee that took place on July 1, 1969, involved discussions about Synthetic Biological Agents. Part of the Congressional narrative (from HB 15090) is detailed below:

"There are two things about the biological agent field I would like to mention. One is the possibility of technological surprise. Molecular biology is a field that is advancing very rapidly and many eminent biologists believe that within a period of 5 to 10 years it would be possible to produce a synthetic biological agent, an agent that does not naturally exist and for which no natural immunity could have been acquired."

Mr Sikes: Are we doing any work in that field?

Dr. MacArthur: We are not.

Mr. Sikes: Why not? Lack of money or lack of interest?

Dr. MacArthur: Certainly not lack of interest.

Mr. Sikes: Would you provide for our records information on what would be required, what the advantages of such a program would be, the time and the cost involved?

Dr. MacArthur: We will be very happy to. The dramatic progress being made in the field of molecular biology led us to investigate the relevance of this field of science to biological warfare. A small group of experts considered this matter and provided the following observations:

1. All biological agents up to the present time are representatives of naturally occurring disease, and are thus known by scientists throughout the world. They are easily available to qualified scientists for research, either for offensive or defensive purposes.

2. Within the next 5 to 10 years, it would probably be possible to make a new infective microorganism which could differ in certain important aspects from any known disease-causing organisms. Most important of these is that it might be refractory to the immunological and therapeutic processes upon which we depend to maintain our relative freedom from infectious disease.

3. A research program to explore the feasibility of this could be completed in approximately 5 years at a cost of \$10 million.

4. It would be very difficult to establish such a program. The science of molecular biology is a relatively new science. There are not many highly competent scientists in the field. Almost all are in university laboratories and they are generally adequately supported from sources other than DOD. However, it was considered possible to initiate an adequate program through the National Academy of Sciences National Research Council (NAS-NRC). The matter was discussed with NAS-NRC and tentative plans were made to initiate the program. However, decreasing funds in CB, growing criticism of the CB program, and our reluctance to involve the NAS-NRC in such a controversial endeavor have led us to postpone it for the past 2 years. It is a highly controversial issue and there are many who believe such research should not be undertaken lest it lead to yet another method of massive killing of large populations. On the other hand, without the sure scientific knowledge that such a weapon is possible, and an understanding of the ways it could be done, there is little that can be done to devise defensive measures. Should an enemy develop it there is little doubt that this an important area of potential military technological inferiority in which there is no adequate research program. "

Actual creation of the virus was done through the Department of the Army at Fort George Meade and through the Department of the Navy. The name of the individual who was head of the Naval development program is known but will not be released at this time.

Congressional Investigation Ties In Savings and Loan
Failures with CIA Manipulation during 1990

It has been maintained that the secret government is getting funding for covert alien and non-alien related activities solely from the profits of drugs which are sold to Americans, but there is increasing evidence that the CIA has been taking people's money right from under their noses. Early this year, the *Houston Post* began running a series of articles after an eight-month investigation that found numerous links between organized crime figures and CIA operatives, including some involved in gun running, drug smuggling, money laundering, and covert aid to the Nicaraguan contras. Taking the cue from this investigation, House banking regulators began to question the CIA, who refused to cooperate. After the CIA refusal, the House Permanent Select Committee on Intelligence began a series of its own investigations. Chaired by Congressman Tony Beilenson, the committee found that a former Department of Justice prosecutor Lloyd Monroe revealed that he was told by the FBI to drop the investigation of one of the individuals connected with a bank failure because that individual had "CIA connections". Monroe was also told that the individual involved had a "get out of jail free card". In a subsequent letter to Beilenson, Representative Frank Annunzio (D-Ill) said, " I know of no get-out-of-jail free card that applies to the CIA. No agency is above the law." One of the owners of a failed S&L was an Iranian named *Farhad Azima*. During the investigation, the CIA told the FBI that Azima was "off limits".

Azima also owned *Global International Airways*, which went bankrupt in 1983. There is evidence that suggests that Global was closely tied to the CIA. One of Globals clients was the Department of Defense. Another of Globals clients was *Southern Air Transport*, and several former pilots have revealed that the company was engaged in running guns to the contras and smuggling drugs back to the United States. The biggest Global client was the *Egyptian American Transport and Services Corporation (EATSCO)*, a shadow company controlled by men like Edwin Wilson, the famous arms dealer who is now in prison in Ohio, Richard Secord, Theodore Shackley (a CIA agent who worked to overthrow Allende in Chile), and others tied to the Carter administration.

One source, a former CIA official working in Washington, told investigative reporter Anthony Kimery (who works for the publication *Money Laundering Alert*) that the failed S&L's in Texas had their assets *illegally siphoned off by the CIA to fund unauthorized covert operations.*

There are probably people in Congress who are not interested in having the national S&L tragedy explained to the American people in detail, the reason being that some Congressmen have been involved with some of the shady operators of some of these failed institutions, having received support from them politically and financially.

Esoteric Chronology

Years Ago	Description and Data
75,000,000	A catastrophe overtakes the 75 planet group of the Intergalactic Federation, creating a virtual cultural desert through fragmentation. Over-population and war. Earth is devastated by nuclear forces. The Wall of Fire.
50,000,000	What humans will refer to as the Orion entities pass through a black hole ring singularity (portal) near Arcturus from point in Andromeda and enter our universe. They settle in the Lyran system
22,000,000	The Lyran wars. Explosion creates the Orion Nebula. Portions of the population go to the Hyades, Vega and Erra systems.
208,000	The Marcab empire begins. The negative Orion groups (Big Nosed Greys) and their cloned slave race (Big Head Greys - "Communion")
150,000	First Lyran conflict.
120,000	Religious implant first implemented to manipulate populace.
100,000	Lyrans visit Earth's polar regions and establish a colony. Hyperborea.
89,000	Technology develops to a high level in the Lyran society on Earth.
75,000	Interplanetary war in Earth's solar system which destroys Maldek, which becomes the asteroid belt.
50,000	Pleiadians groups flee the Lyran system. Some come to Earth. The EL's (Elders) imprison the negative parapsychical entities under the surface, locked in a specific frequency.
49,000	Pleiadian groups, Atlans, live in peace on the Earth. First Atlantis. 70,000 scientists.
40,000	Conflict on Earth. Nuclear War. Two thousand flee Earth to Pegasus system. Earth radioactive.
33,000	Pleiadians return and rebuild Atlantis. Genetic cloning and crystal technology. Slave races are generated.

32,000 Atlantean-Mu Wars. 12,000 dissidents leave Earth

14,000 Law of One established in Atlantis. Constructive religious implant.

12,400 Descendants of 12,000 who left 20,000 years before, led by Arus, return to Earth and engage the Atlanteans. Greys decide to use humans as slaves against the Pleiadians.

11,500 Atlantean civilization on Earth is decimated.

10,200 Grey-Marcab society is fragmented after war. Mercenary groups continue to subsist on animal and human biological products and experience sensation from human emotional fields.

8,000 Period when Pleiadians cross-breed with Earth humanoids. Blond races visit Earth.

4,000 Aryans and alien mining groups conflict. Nuclear explosion in area of modern Pakistan.

3,400 Pleiadians leave Earth.

3,000 Sethians interact with the people in what is now Egypt, and try to take control of the planet and attempt to sell it to the Pleiadians. Some of the pyramids are built.

81 Alien craft crashes in Siberia. Anti-matter engine explodes.

70 Greys continue manipulation of humans and use of animals.

52 Germans recover crashed disk.

40 Disk crashes in Southwestern USA

36 Pleiadians contact US Government and offer spiritual aid. Refused.

32 Government begins relations with Greys.

Theoretical

Distribution of Cultures from Lyrae

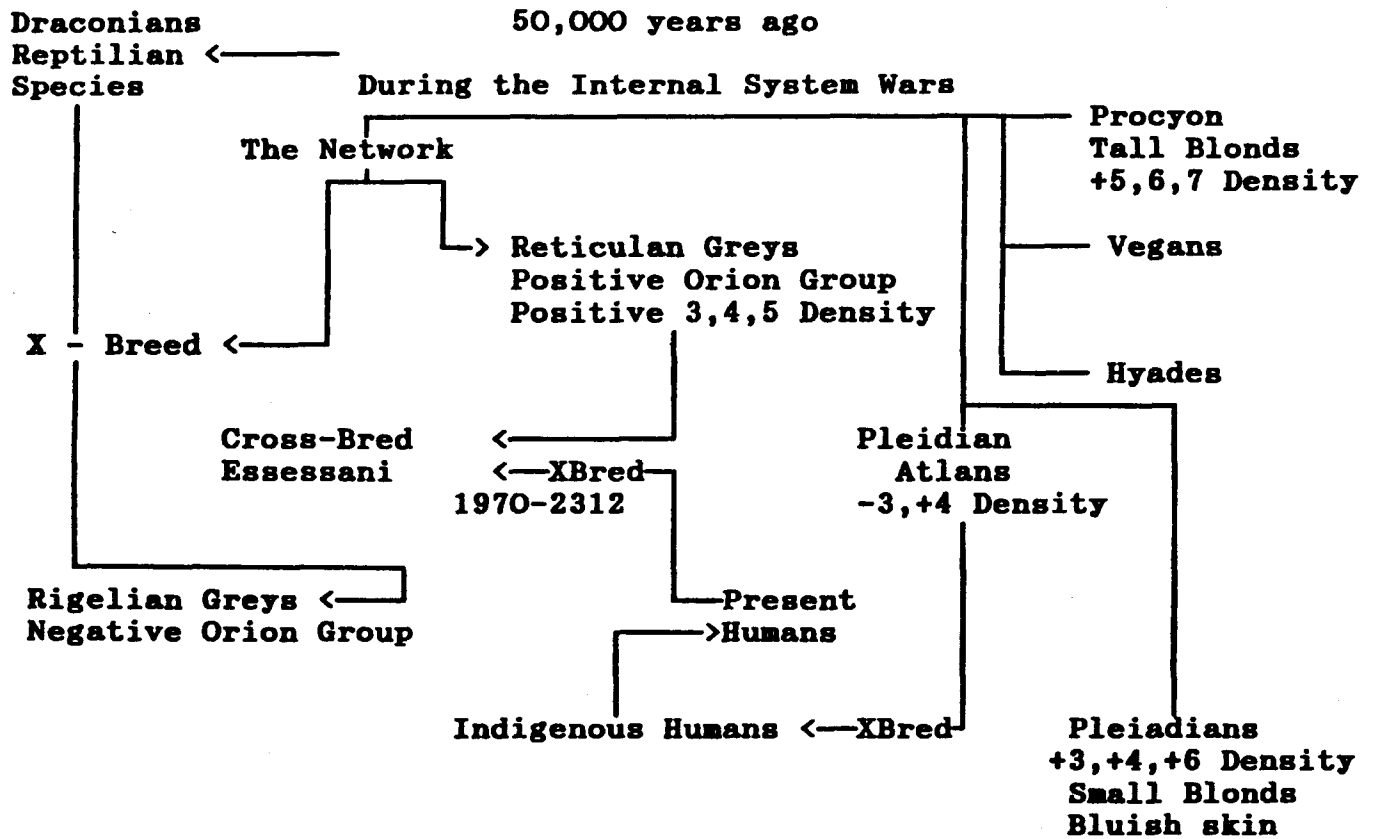

Abduction Case Where The Abductee Was Cloned

Among the strangest features presented by alien abductees is the claim that cloning of humans is taking place. On February 28, 1974, Dirant Ferraz was 18 years old. He was at home in Brazil standing in his kitchen, when he suddenly found himself "somewhere else". It was a square room, and a voice resounded through the room and said, "Keep calm, we are your friends". Dirant was able to pinpoint this voice as coming from a box in the corner of the chamber. It occurred to him that it might be a translation device.

In the blank wall before him there appeared a door, which opened. From within the door emerged a large egg-shaped machine, which came toward him. In the hall where he was standing a yellow light came down on him from the center of the funnel-shaped ceiling, and again he heard a voice trying to tranquilize him.

Then, from the egg-shaped machine, there emerged a double of himself! The same voice then asked him to touch the replica, and when he did so it felt completely like flesh. Next, the double proceeded to pat him on the back, saying: "Keep calm! Wish me a good journey, for I do not intend to harm anybody." This other being's voice was a replica of his own.

There was a large panel on the wall through which Dirant watched his double relaxing in his own home. This other being's behavior was different from his. The double showed quite clearly that he did not know how to handle money or understand its value. The double also could not write.

Dirant was directed to assist his "other self" by means of the TV-like panel. The effect of this was that he had the sensation of looking through the other one's eyes, which were fixed in their sockets. At other times, he felt himself to be above the double, trying to advise him how to act.

On several occasions the screen was turned off, as when the double walked off and left the house in the morning or when he made the driver stop the car so he could step out into the tropical rain forest of Quinta da Boa Vista. Dirant never discovered what the double did in the rain forest, but he did observe him taking photographs of the Niteroi bridge near Rio de Janeiro. The double seemed to be concerned about the welfare of plants and trees, and he mended the broken bough of a tree. Dirant checked up on this after returning home. Otherwise, the behavior of the cloned double was rough, and he ill-treated everyone around him.

While Dirant was watching his double (from 7:30pm on February 28, 1974 to 7:30pm on March 1, 1974) he felt no hunger, thirst, or sleepiness. Now and then he would lie on a bed fixed to the wall. There was a shelf beside him. There was also a movable stool which he took over to the shelf whenever he needed to do so. The shelf had a purpose, as he soon discovered.

Dirant became bored at times, watching his double. He expressed the wish to have something to read. Presto! Up came a newspaper, some books, and the magazine "Spider Man" (which he later discovered was not yet on sale on the newsstands). Every time something came up, a red border outlining the shelf lit up.

Dirant eventually found himself longing for some company, especially his girl friend. Finally, his double retrieved a letter which had just arrived from her. Up it came, right to the shelf.

Dirants watch had stopped at the moment of his abduction, and started working again as soon as he arrived home, turning to 7:31 pm a second after he arrived - all this after a lapse of 24 hours.

That he had been absent and that somebody had replaced him seemed to be a moot point with his family.

In addition to these other characteristics, the double had the faculty of passing through walls, and he gave one of the firms employees a scare by suddenly appearing behind him.

After the double disappeared for the first time, Dirant started asking questions of his captors. According to his captors, his double was "an image that can be touched. Inside him there is one of ourselves and a recording of your mind."

According to Irene Granchi, the Brazilian investigator who worked on the Dirant case, there are several other cases (both in Brazil and elsewhere) that involve either human-like beings or others, who came out of egg-shaped machines.

NOTES

Replacement of Humans

By

Synthetic People

This is, for many people, one of the most controversial issues that has arisen during investigations into the relationships between "humans" and "aliens". The concept of synthetic life has been known among humans for thousands of years. The manipulation of biological lifeforms is a capability that arises with time, and it has both its good and bad points when viewed from different perspectives.

There is absolutely no doubt that replication of humans is an ongoing process that has a part to play in the manipulation of events on this planet. Hundreds of individuals over the last twenty years have attested to what they have seen, both on alien craft and in underground installations....the synchronicity and sheer weight of corroboration from vastly unconnected sources is damning evidence that this is occurring.

A lot of evidence started to surface in the 1970's. A lot of it seemed to tie in the idea that political figures have been undergoing a process of duplication. During this process, the individual's responses, memories, and habit patterns are copied from the human to be duplicated. The original can then be preserved or processed into basic biological components. The clone will then function as the original, except that the entity is under alien control. There is also an apparent minority of cases where the synthetic duplicate's consciousness is directly replaced by an alien consciousness - the walk-in.

Can these synthetics be detected? Do they have differences from regular humans that can be seen? The answer is yes. Information has surfaced over time about what those differences are. In a walk-in situation, the alien consciousness could be used to a biological matrix that provided three fingers on each hand, for instance. Having an organic body with five fingers could mean that there would be two fingers on each hand that would not be used normally, if at all. This idea was once expressed in the "Invaders" series on television, which was pulled off the air prematurely. Roy Thiness, the main character in the show, has had some experiences of his own relative to the theme of the program.

There are other factors that should be looked for. One of them is the eyes. There are three aspects of the eyes that have been mentioned: One eye is different (darker) than the other; the eyes

are bulging (like cow eyes); the eyes depict a blank expression. Thus is not to say that people who have this appearance are synthetics, but these are said to be indicators.

Another factor that is said to apply to synthetics is that they do not have a long life span. It is said that they do not function well beyond a couple years; some political figures have been said to have been replaced several times.

What follows below is a collection of pictures of prominent political figures that have been submitted to us, and the comments relative to the pictures:

One Eye Darker Than the Other
(said to hold optical sensor)

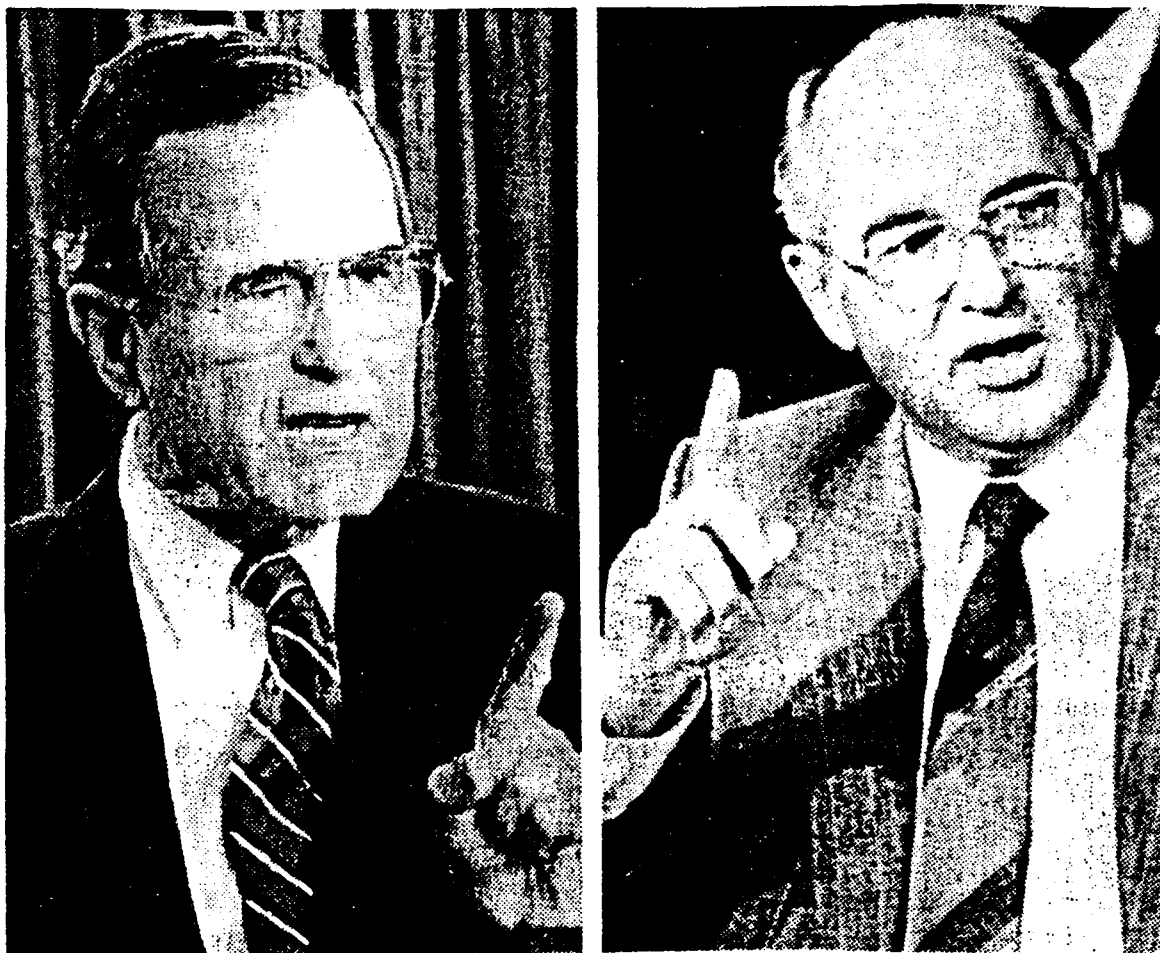



1985 CASPAR WEINBERGER
Heads Defense Department.

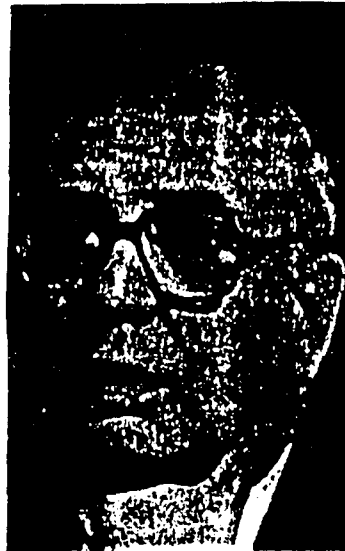

PAUL VOLCKER



1987
HEAD TO HEAD—Republican Sen. Jesse Helms (N.C.)



These people could look like this by virtue of the American political system, never mind being cloned and manipulated. Like the movie "They Live", we may not find out for sure until it's too late.

Vacant Look Behind The Eyes

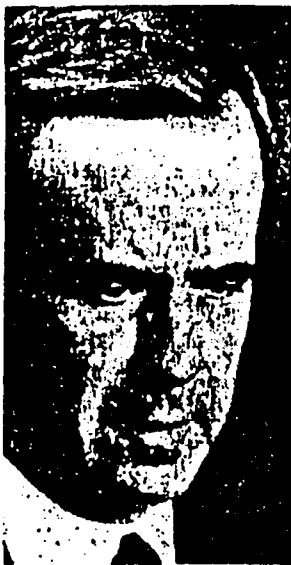

Robert C. McFarlane 1983
Meets with Syrian president today



REP,
ILLINOIS
1989
PHILIP CRANE

One Eye Darker Than The Other

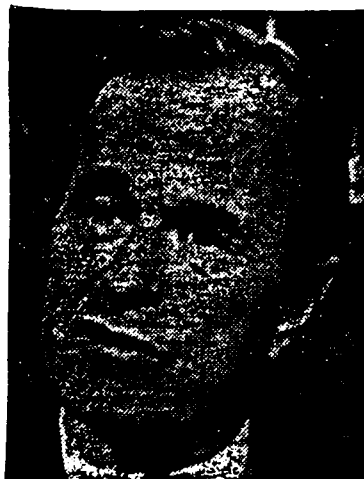

BOWIE: "Cruel"



Brzezinski, 53, who served as national-security adviser in the Carter administration from 1977 to 1981, now is a professor of government at Columbia



Alexis de Rede with Marie-Helene de Rothschild in Christian Lacroix

**Absence of Normal Contralateral
Movement During Running
(Bush. below)**



Bush and Atwater run on Iowa campaign trail that led to victory on Election Day.

In the late 1970's and early 1980's a gentleman named Dr. Peter Beter (see bio on next page) revealed information that he knew about synthetics and political figures. He concentrates heavily on the Carter Administration, although there are many others said to be involved. It is quite logical for processes such as these to be happening, in view of the planetary power structure and the aliens that are involved.

Let's take a look in the following pages at what Peter Beter has to say about synthetics and replacement of political figures.

From: WHO'S WHO IN THE EAST 1977-78, 16th Edition, page 65: ABOUT DR. PETER BETER

Legal consultant, commentator.
Born Huntington, West Va. - June 21, 1921
Son of David Sowan and Sophia Moran (Morone) Beter.
Student, University Detroit 1943-46.
B.A. West Virginia University 1947.
Dr. of Jurisprudence (J.D.) Geo. Washington Univ. 1951, LL.M. (Master of Laws) 1958 Geo. Washington Univ.
Married Lillian Olga Fink - July 23, 1965.
Children: Alexander Mathias
Josee-Marie Elizabeth
Petra Christina.
To Dist. of Columbia bar 1951, West Va. bar 1959.
Practiced in Washington 1951-61.
Rep. American Gold Assn., Washington 1958-61.
Legal counsel Export-Import Bank, U.S. Washington 1961-67.
Director-Treasurer, general counsel Sodasair, S.P.R.L., Kinshasa Republic du Zaire (Congo) 1968-73
Counsel, United Hard Hats of Amer., Inc. 1973--
Commentator, Monthly Audio Newsletter (tape cassette), Audio Books, Inc., Ft. Worth, 1974--
With Georgetown University, Foreign Service School, Washington 1952-53.
Pres., S.W. Citizens Assn., Wash. 1952-54.
Director, Citizens Crime Commission, Met. Washington 1952-61.
Chairman, American Patriots Committee, Washington 1974--
Republican candidate for Governor, West Va. 1967-68.
Member Federal Bar Assn., Soc. Am. Judiciary, Phi Beta Gamma (chief justice) 1949. Catholic.
Club: Bankers of America (N.Y.C.)
Author: Gold Positions of U.S.A., 1958. Gold and Gold, 1959.
The Conspiracy Against the Dollar 1973.
Editor: Spiritual Practices, 1972.
Producer (record) Chorale Congo, 1968.
Office: 1629 K St., N.W.
Washington, D.C. 20006

FROM AUDIO LETTER # 46: (MAY, 1979)

What I am about to reveal I am revealing primarily for history. I know even before I reveal it that some of my listeners will desert me after they hear it, saying 'it just cannot be'; but, my friends, I also know that the events in the days ahead will be impossible to understand without knowing this secret. So I do not ask that you believe it simply because I say it. What I do ask --and I ask it for your own good-- is that you keep an open mind. Listen and hear what I must now reveal, then watch events themselves.

My friends, since World War II and before, scientists the world over have been probing for the basic secrets of life itself; and in this field as in others, progress has been much faster than the public has been led to believe. Today it's common knowledge that heredity is governed by something called genes, yet barely a generation ago this relationship was only beginning to be suspected. When it was suggested in 1944 by a theoretical physicist, Erwin Schrödinger, it was a novel idea. Beyond that no one was too certain what genes were aside from huge molecules or clusters of molecules. Some thought they were molecular chunks of protein, some thought they were something else. When Schrödinger's ideas about genes were published, World War II was still raging and basic scientific research was on a back burner; and yet, barely a half dozen years later, researchers were seeing in on a building block of life even more basic than genes. The solution was found to this revolutionary puzzle in April 1953 at Cambridge University in England. Scientists James Watson, Francis Crick, and Maurice Wilkins were later to share the Nobel Prize for solving the puzzle. They had discovered the molecular structure of DNA, the famous "double helix." In 1968

Watson published a book titled "THE DOUBLE HELIX," published by Atheneum, New York, N.Y. To understand the overwhelming importance of the double helix discovery in 1953, one need go no further than these few words on the jacket of the book:

"DNA is the molecule of heredity, and to know its structure and method of reproduction enables scientists to know how genetic directions are written and transmitted, how the forms of life are ordered from one generation to the next."

In other words, to understand DNA is to begin to understand life itself.

It has now been over a quarter of a century since the crucial discovery of the DNA, double helix, and since then research in molecular biology has not been standing still but speeding up. In some cases research has gone in directions which are deliberately sheltered from publicity because of the fear of public reaction. Not so long ago, for example, universities doing research into artificial microbes found their neighbors in an ugly mood when they found out about it. Test tube babies are now a reality, and that began not long ago in England where the mystery of DNA was first unraveled. Then, of course, there are clones--that is, creatures which are reproduced by artificial means and which are exact duplicates of an original. Clones of all kinds of animals have been produced successfully in the laboratories, but that is not what bothers people. In the recent past it has been claimed that human clones are also possible and that some may already be in existence. These last claims about human clones have been ridiculed, denied, and suppressed by all kinds of officials--the reason is that the idea of duplicate human beings impinges upon a super-secret realm of Intelligence activities by both Russia and the United States. True clones are not involved, but something that bears a superficial

resemblance to cloning is going on; and the last thing the powers-that-be want is for you and the public to have any hint about what is afoot.

In Russia as well as in the West, research has been under way for many years in biological synthesis--that is, artificial life forms; and according to high intelligence, a stunning break-through took place in Russia some years ago. The Russians refer to this break-through as a "providential discovery," something they learned almost by accident. They discovered the key to creating what are known as "organic robotoids." An organic robotoid is an artificial robot-like creature, it looks and acts exactly like a human being and yet it is not human. A robotoid is alive in a biological sense but it is an artificial life form. Robotoids respond to conventional routine medical tests in the same way as humans do; they eat, they drink, they breathe, they bleed if cut; and they can be killed. Robotoids can also think, but they think only in the sense that a computer thinks. Like any other computer, the brain of a robotoid has to be programmed for each assignment it is given; but unlike many electronic computers, the biological computer-brain of a robotoid possesses an enormous memory. As a result, robotoids can be programmed to communicate and think in such complex patterns that they act human.

Organic robotoids are remarkable creatures, but they have many drawbacks. They don't grow or reproduce but must be manufactured one by one in the desired form. They also have a very limited life span, measured in months or even weeks, depending upon how they are utilized. This is due to the fact that their metabolism, while it resembles that of humans, is very inefficient. A robotoid can be manufactured on very short notice, a matter of hours; but after a few weeks or months it suddenly begins to degenerate physically and mentally. When that takes place, the robotoid has to be removed from service and disposed of. To extend its useful

life as much as possible, a robotoid is customarily cooled down to allow its metabolism between assignments. Organic robotoids are extremely expensive, troublesome creatures to produce and utilize; and robotoid capabilities do not exceed those of human beings. All they can really do is simulate human beings; but, my friends, for Intelligence purposes that's all they have to do!

To produce an organic robotoid it is necessary to have a pattern to go by. The pattern required is that of genetic coding taken from a few cells from the body of a human being. In this respect the Russian technique sounds like cloning, but the technique itself is totally unrelated to genuine cloning. A robotoid is produced within a matter of hours, and it simulates a human donor at his current age. Like any man-made copy of anything, a robotoid is never a perfect copy of the human that it is to simulate; there are always small discrepancies in appearance and behavior, but these are seldom great enough to arouse any suspicion.

When the initial Russian break-through in robotoids took place years ago, the Rockefeller-Soviet alliance was still functioning. The Christian group who now rule Russia were already secretly more powerful than the Bolsheviks, but the final overthrow had not yet taken place. When the robotoid break-through took place, they moved quickly to minimize the amount of information obtained about it while these Bolsheviks still retained positions of power. They also tried to prevent information about it from leaking through intelligence channels to the CIA, nevertheless partial information did reach the CIA in the late four Rockefeller brothers. By early 1975 the Russians were known to have successfully created at least one organic robotoid in the laboratory. Meanwhile the CIA was coordinating a feverish research effort aimed at accomplishing the same feat. Up to now, robotoid technology in the United States is far behind that of Russia. The American capability robotoid is not even

close to being operational, whereas the Russians are deploying them right now.

But there has been at least one attempt to create an organic robotoid for public use in the United States, and I am referring to the final fate of the late General George S. Brown. In April 1977 I revealed how much General Brown had sacrificed by that time as the price of doing his duty for America, but not long after that General Brown paid the supreme price for his actions. It is only now that I am free at last to reveal it.

On July 10, 1977, General Brown was taken to CIA headquarters near Washington, D.C., in Virginia. There he was taken to one of the many secret rooms designed into the CIA building by Melson Rockefeller. The room was a laboratory, and the attempt was made to create a robotoid replacement for General Brown. The techniques employed were far more crude than those used in the Russian process since the CIA process required General Brown to be on the scene. The attempt ended in complete failure. A crude facsimile of General Brown was generated but it refused to come to life. Even so, General Brown could not be allowed to live because now he knew too much; and so on the evening of July 10, 1977, General George S. Brown, the last great patriot in the United States Government, was MURDERED.

A normal "human double" was found for General Brown since a robotoid attempt had failed. This was the man who testified in the role of General Brown at the Congressional hearings on the Panama Canal Treaty September 27, 1977! At his side throughout, briefing and prompting him, was the Secretary of Defense, Harold Brown. Occasionally the "double" would be flustered by a question and looked down at the table in front of him until the Defense Secretary whispered something in his ear. Then he would look up again, say what he had been told, and so on. Once the Panama Canal hear-

ings were out of the way, the "double" for the late General Brown was seen as little as possible in public; soon there were stories that he had contracted cancer. Then the Air Force Chief of Staff, General David Jones, began acting as Chairman of the Joint Chiefs months before the end of General Brown's tour of duty. In June 1978 we were told that General Brown was retiring, and last December 5, 1978, we were told that he had died of cancer. At that point the General Brown "double" collected his pay and headed for Frankfurt, West Germany, where he landed on December 11, 1978, at 3:30 AM local time. It is the standing rule that "doubles" for important people never live long, and so at about 7:30 that evening General Brown's "double" was shot to death in the back of the neck.

Last month I revealed that an Intelligence war of "doubles" had erupted in the United States. President Carter, Vice-President Mondale, and their wives, had fallen victims to this war of "doubles" as their Easter breaks away from Washington were ending. Now I am sorry to report that Amy Carter, Billy Carter, Lillian Carter, and Hugh Carter all died soon after Jimmy and Rosalynn did. All of them, including Amy, have been replaced by "doubles"; but instead of the Bolshevik "doubles" who had been waiting in the wings, those we are seeing are Russian organic robotoids. The voice of the Jimmy Carter "double" which was reproduced last month in Audio Letter No. 45 is the voice of a robotoid. That robotoid was the one who was dassing everyone with his vigorous new image. Only a few months ago Carter had been limping around with what we were told were severe hemorrhoids; but now, out of the blue, here was a Carter who was a powerhouse--hiking, fishing, and jogging ten miles a day, he also looked and sounded younger than before--that was the first robotoid "double" for Carter which I referred to last month as Carter No. 2. By the time I recorded Audio Letter No. 45, there was also another Carter robo-

toid making the rounds--this one, Jimmy Carter No. 3, was the one that attended the Holocaust observance in the Capitol building here in Washington. By contrast with Carter No. 2, No. 3 looks noticeably older and more haggard. As I mentioned earlier, robotoids are very good copies but they are not perfect, no two look exactly alike.

Last month I mentioned that the "doubles" for Jimmy and Rosalynn Carter were spending a great deal of time at the Russian Embassy here in Washington instead of at the White House. Now I can tell you why. Robotoids are programmed at the Embassy for each assignment, between assignments they simply rest there in a state of reduced metabolism.

When the Bolshevik coup d'état

against the Rockefeller's began four months ago, the Kremlin rulership already knew that Bolshevik "doubles" would soon be on the scene and they knew that if the Bolsheviks were allowed to complete their take-over of the United States, Russia would soon suffer. The Bolshevik plans for nuclear war against Russia are a blueprint for suicide for America--but they have not been abandoned. Up until now the Russians had been keeping the robotoid capability under wraps, and there was a real question whether they would ever be used; but the Bolshevik coup d'état convinced them that the time had come to deploy the robotoids. Now they are using Nelson Rockefeller's "Hit List," and using their robotoids the Russians have already altered the course of world events in dramatic ways.

The Intelligence war now going on is intense, and the situation is changing daily. Bolshevik strategies have been badly jolted by the Russians using their robotoids, and as a result the Bolsheviks are not sure what propaganda line to feed to the public right now. A major shock to the Bolsheviks in recent days

has been their loss of the "ad hoc gang of four." First, I can now report that Brzezinski was with the Bolshevik "double" for the late Vice-President Mondale last month on April 20. They were aboard Air Force II which crashed in the North Atlantic, as I reported last month. Then on May 13 the other three were eliminated--Blumenthal, Brown, and Schlesinger. All

four were promptly replaced with Russian robotoids, as has been done with the Carters and the Mondales. A number of other top officials have also been removed and replaced by Russian robotoids. Last month Secretary of State Cyrus Vance was replaced; and on the 1st of May, May Day, the American Association of Newspaper Editors were treated to speeches supposedly by Vance and Brzezinski. In the past, Vance and Brzezinski have always been noted for being at loggerheads on every issue; but this time, as they spoke of the need for a new diplomacy by America, it was as if they were both thinking with the same mind. Many observers were surprised but no one suspected the truth.

As there begin to be more and more Russian robotoids in key positions of the United States Government, there will be more and more surprises. One key public personality I would urge you to watch very carefully now is Walter Cronkite in his television broadcasts on CBS "Evening News." During this month of May he left on what was said to be a vacation. Today, May 28, he resumed broadcasting. If you are accustomed to watching the Cronkite NEWS program, I suggest that you watch carefully now, look for a change in the slant given the news--it will be subtle, but it will be there. If you are serious about it, you might tape the shows every evening for a week, then play them all back one after another sometime the following week-end. In that way you can compress a week into two hours or so not counting commercials, and better tell what the drift is. Otherwise the most important sin-

gle personality to watch is the one labeled "Jimmy Carter." Periodically there will be small changes in his appearance and behavior as one robotoid wears out and is replaced by another; and by listening to the Carter robotoids, you can get some hints about what the Kremlin is up to.

The invasion of the Russian robotoid goes far beyond the mere removal of troublesome people from official positions. Robotoids assume the identity and authority of those whom they replace. As a result they can carry out official acts, give orders, and sign agreements. A prime example is to take place next month in Vienna, Austria, on June 15. To the world it will appear that the United States in the "person" of President Carter will be signing the SALT II Treaty with Russia in the "person" of President Brezhnev; but the signatories will actually be a robotoid that looks like Carter, and a human double who looks like Brezhnev. Over a year ago in Audio Letter No. 33 I reported the January 1978 death of the real Brezhnev and his replacement with Brezhnev No. 2. So the SALT II Treaty will actually involve Russia signing with itself through puppet personalities!

FROM AUDIO LETTER
47. (JUNE, 1979);

The same thing is happening now in the wake of my revelations last month about the "Russian organic robotoids." The conventional wisdom, of course, is that there just cannot be such things; or at least if they are possible, they must lie far in the future, not now. But, my friends, the conventional wisdom is wrong, dead wrong. They are not only possible but they are real, and they are walking among us right now. To

those who are ignorant of the scientific advances that have taken place in the past 20 to 30 years, they sound incredible; but within a small select group of scientists both in and out of government, here and abroad, the existence of Robotoids is known, and certain of those who know and understand about them are faithful listeners to "The Dr. Beter AUDIO LETTER." As I mentioned in my introductory comments, those who seek to control us want to keep us all in a horse-and-buggy mentality. That way we remain unaware of the forces we are confronting and therefore more vulnerable.

Ever since World War II began four decades ago, we Americans have been living with a shroud of secrecy in the military and scientific fields. As a result, most Americans today are actually living in the past without knowing it. But in my AUDIO LETTERS I am trying to bring you up to date with reality. For the past four years I have been letting you in on developments which have taken decades to materialize in secret. Learning about all these things over such a short time span is like having the world itself change almost

over night. So it is little wonder that some of my listeners are getting a case of "future shock" from my AUDIO LETTERS. By the way, the term "future shock" is taken from the famous book titled "FUTURE SHOCK" by Alvin Toffler. The book was published nearly 10 years ago, in 1970, by Random House. Toffler defines future shock as "the shattering stress and disorientation that we induce in individuals by subjecting them to too much change in too short a time." In his book Toffler called attention to the fact that numerous rapid and drastic new developments are taking place today without people quite knowing how to cope with it all. Among these developments Toffler discussed the revolutionary advances in biology and genetics, quoting leading scientists in the field. He gave examples of astonishing things which are either possible now or will be soon. All of these are fascinating to read about and many are frightening as well. In particular, several items point directly toward organic robotoids, although the book does not say so. As I explained last month, an organic robotoid is an artificial robot-like creature. It is a kind of

biological machine with a biological computer brain. With this in mind, consider the words of Arne Tiselius, a biochemist and Nobel Prize winner. As quoted in "FUTURE SHOCK" nearly a decade ago, he said: "It is quite obvious that computers so far are just bad imitations of our brains. Once we learn more about how the brain acts, I would be surprised if we could not construct a sort of biological computer. Such a computer might have electronic components modeled after biological components in the real brain, and at some distant point in the future it is conceivable that biological elements themselves might be parts of the machine."

Dr. Tiselius was on the right track with these words of 10 years ago, but he was too conservative. At that time, the Russians were already on the threshold of their key breakthrough which I referred to last month. That breakthrough had to do with the biological computer brain which is the key to a successful robotoid. In a few moments I'll tell you more about that.

In other places, too, one can find many bits and pieces of information that point straight toward robotoids, but you will not often find this information on television or in the newspapers. Instead, it crops up here and there in specialized publications directed at particular audiences. An example of this is the book "THE DYNAMICS OF CHANGE" published in 1967 by Prentice-Hall, Englewood Cliffs, New Jersey. The book is copyrighted by Kaiser Aluminum & Chemical Corporation, having first published all the material in six issues of "Kaiser Aluminum NEWS."

The revolution in biology and genetics is only a very small part of the subject matter in the book. Even so, listen to just a few brief quotes. Under the

heading GENETIC MANIPULATION: "The ability to control the formation of new beings may be one of the most basic developments of the future. Recent discoveries about the nucleonic acids, the basic building blocks of life, have led to the belief that man may some day be able to treat genes in such a way that desired characteristics can be realized..." Under the heading DIRECT EDUCATION OF BRAIN CELLS: "Experiments indicate that certain chemicals in the brain will, when implanted in another brain, transfer knowledge..." Under the heading MAN-MACHINE SYMBIOSIS: "...Computers exist which can learn, remember, see, seek goals, reason, walk, sing on key, talk, be irritable, play games, grasp, adapt to an environment and even design improvements in themselves..." My friends, remember these things were published for public consumption, and a dozen years ago! Furthermore, under the same heading: "...man-like computers may one day contain plasma circulating through a viscera-like envelope, allowing them to be self-healing." Finally, under the heading HUMAN ROBOTS: "...An electronic circuit that imitates two neurons, the cells of the human brain, has been built, and has enabled a robot to deal with some unexpected situations, but the neuron structure was bulky. The brain has billions of neurons, meaning an incredible miniaturization job will be necessary before truly 'human' robots are developed."

Since those words were written, of course, incredible things have been done in miniaturizing electronic computers. For example, a mere dozen years ago there was no such thing as an electronic hand calculator. Within a few years they were on the market but at a cost of hundreds of dollars. Today, just a few scant years further on, they are all over the place—tiny, inexpensive, and able to do things only bulky computers could do a decade ago. But these things only hint very vaguely at the scientific strides that have made Organic Robotoids a reality.

The man-made biological machine known as a Robotoid is remarkable from head to foot; but the most astonishing thing about them is their ability to simulate human beings—not just in appearance but in behavior. In other words, the most crucial and most amazing thing about a Russian Organic Robotoid is its biological computer brain. The developments that were destined to lead to Russia's breakthrough in robotoid brain research began 32 years ago, in 1947. In that year a Hungarian-born physicist, Dr. Dennis Gabor, conceived of a way to make three-dimensional photographs called "holograms." It was a revolutionary scientific discovery, and it was destined to lead to the Nobel Prize for Dr. Gabor. He did not receive the Prize until 24 years later, in 1971. By then, holograms were a reality in numerous laboratories world-wide; and yet most members of the general public still had not heard of holography. And even today, more than three decades after Dr. Gabor's original discovery, holography is still unfamiliar to the public as a whole. In 1947 Dr. Gabor's theory pointed the way toward holography, but at that time holograms could not actually be made. What was needed in order to make them was something called "monochromatic light"—that is, light of just one wave length. No one knew how to create that kind of light in 1947, but in 1960 the situation suddenly changed—that was the year the laser was invented. When lasers are discussed in public, attention is usually focused on just one of their amazing characteristics—that's the ability of a laser to produce a narrow, intense beam of light. The beam can travel great distances without spreading out into fusing. Lasers pointed the way toward energy-beam weapons, among other things; and as I revealed long ago in AUDIO LETTER No. 26, this is what secretly spawned America's crash program to get to the moon in 1961. But the reason laser beams behave the way they do is that the light they produce is monochromatic, so they are made to or-

der for generating holograms. Like lasers, holography has led to developments that were totally unexpected, and one of these was the Russian breakthrough in biological computer brains some years ago. When you hear how they work, you will understand why robotoids act so much like the human being they replace.

A hologram is a very unusual kind of photograph. To make one, the film is exposed using a laser and a set of mirrors and lenses; and to make the hologram image on the film visible later on, laser light must again be used. When you look at a hologram, it is as if you were looking through a window at the real object. You can move back and forth, up and down, and see it from different angles in three-dimensional detail. By contrast, of course, a conventional photograph is flat and looks the same from all angles. Holograms are also different in another way. If you tear a normal photograph into several pieces, you ruin it. Each piece contains only a disconnected fraction of the total, but not so with the hologram. If you cut up a holographic film into several pieces, each piece still contains almost the entire image. There is some loss of detail but basically it's all there. It's this fact that led years ago to the Russian breakthrough in biological computer brains for their robotoids.

For quite some time, scientists in the Intelligence Community world-wide, studying the human brain, have known one very important fact. That fact is that a portion of a human brain can be removed through accident or surgery and yet the person still retains most of his original memory, so in this respect the memory in a human brain is like a hologram. Nowadays the relationship between holography and human memory is beginning to be understood in the West. For example, Dr. Karl Pribram, a neuropsychologist at Stanford University, wrote about it recently in the magazine "PSYCHOLOGY TODAY." As he pointed out, the implications of

holography are enormous, both for brain research and for computers; but this relationship was first recognized not in America but in a research laboratory at Russia's Siberian Science City, Novosibirsk.

Last month I revealed that the Russians can manufacture organic robotoids, which are almost exact carbon copies of real human beings. This is done by a process that simulates the genetic coding of the person to be copied. It sounds a little like cloning, but it's not. A clone of a human would itself be a human, but an organic robotoid is NOT human. It's an artificial life form, like an animal in some ways but like a computerized machine in others. Every Russian robotoid has what is called a "holographic brain." This brain duplicates essentially the entire memory of a person being copied. The key to doing this is a new technique called "an ultrasonic cerebral hologram." Using high-frequency sound waves, which are inaudible, a complete three-dimensional picture is made of a person's brain. This is a painless, non-destructive process; and under the proper conditions it can be done without the person even being aware of it.

Last month I revealed that the Russians are using Nelson Rockefeller's "Hit List" to weed out Bolsheviks here in America, and for roughly three years they have been preparing for this day. They have been secretly making cerebral holograms of the people on the list at every opportunity. This has been done to every person on Rockefeller's list who has visited Russia or Eastern Europe in the past three years.

When an organic robotoid is made to simulate, for example, our late President Jimmy Carter, two major factors are involved. One is the genetic coding required to simulate Carter's appearance, voice, fingerprints, and so on. The other is a holographic image of Carter's brain. This image is a complete record of the neuron patterns which existed in Carter's brain at the moment

the hologram was made. Therefore it contains all of the memory and knowledge Carter had up to that moment. When a Carter robotoid is made, the biological computer in its head is caused to form according to the holographic record of Carter's brain. However, certain portions of the robotoid computer are caused to deviate from the holographic record, and the end result is a biological computer which has to be programmed but which contains essentially all of Carter's memory, involuntary mannerisms, and the like. As a result, a Carter robotoid will automatically do certain kinds of things without the need for specific programming. For example, a Carter robotoid will seem to recognize old friends. That's because the computer memory of the robotoid reproduces Carter's memory of that friend. The holographic process puts it there automatically without the Russian programmers even having to know it's there.

Organic robotoids are such amazing creatures that they are still a subject of questioning and debate. This is true even among the Russian scientists who made them a reality. For example, robotoids seem to have no true instinct for self-preservation. In this regard they act like machines, simply doing as they are told to do. By contrast, both humans and animals generally have the instinct for self-preservation. Robotoids can be programmed for self-preservation, but they are equally willing (if "willing" is the word) to perform suicide missions, exploratory one-way trips into space. I've only one example of this: if a space mission looks too dangerous to risk the life of an experienced cosmonaut, a robotoid can now be used. The robotoid copy of the cosmonaut is already trained the moment it's made, thanks to its holographic memory.

Organic robotoids look and act so much like human beings that it's hard for us to get used to the idea that they are not human; but the Russians decided several months ago that the

stakes are too high not to employ them, and so the silent Russian invasion of America by robotoids is now well under way.

FROM AUDIO LETTER # 48 (JULY, 1979):

Topic #2--Two months ago I revealed that a revolutionary new intelligence weapon was being introduced by Russia. I referred to their "Organic Robotoids." These are man-made robot-like living creatures, perhaps best described as computerized animals. They are designed to simulate human beings almost perfectly in appearance and behavior, and yet they are not human. Robotoids are so far removed from the knowledge and experience of most people that they are very difficult for many people to believe, but now more and more major surprises are filling the news--that is, they are surprises if you do not know about Russia's robotoids.

Robotoids, my friends, are a very powerful weapon; but as I pointed out in AUDIO LETTER No. 46, they are also very troublesome. They do not live long, especially under conditions of constant exposure and stress. They must also be programmed, and yet they are also somewhat unpredictable. Last month I described the process by which the holographic brain of a robotoid reproduces the memory of a person being duplicated. Other parts of the brain are altered so that the robotoid ends up as a robot-like being that obeys instructions, but the memory includes involuntary responses which sometimes produce unwanted behavior. This is turning out to be a severe problem in the case of the Jimmy Carter robotoids, because the real Carter had mental instabilities which are reproduced partially in the robotoids. The first signs of erratic behavior by the Carter robotoids came in public comments about Senator Kennedy. The real Jimmy Carter had a strong personal dislike for Kennedy and on

several occasions Carter robotoids have simply blurted out these reactions in very raw form. To a degree, this type of thing is a danger with all robotoids—they do not possess truly human judgment. They appear to have it under certain conditions, but this is the result of programming for those situations. The problems of instability and short life cause robotoids to be best suited for interim purposes. For long-term purposes, human agents are still the best. For that reason, don't be surprised to see more and more new faces in high positions. Some of the new faces will themselves be robotoids, but some will be human beings.

The Carter crisis of recent days demonstrates two things at once: one is the extent of secret Russian control that now exists in Washington, the other is the difficulty the Russians themselves are having with their robotoids.

On July 1, Carter robotoid No. 4 returned to Washington from South Korea following the "Economic summit" in Tokyo. The scheduled Carter holiday in Hawaii was canceled, and the next day a Carter Energy speech was scheduled for the evening of July 5. Then the Carter robotoid family disappeared to Camp David. Jimmy Carter robotoid No. 4 was burning out, and was disposed of. Robotoid No. 5 was next in line and had already been tried out several times; but on the 4th of July, the day before the scheduled speech, Carter robotoid No. 5 went berserk. It was disposed of, leaving only robotoid No. 6 on deck. Each new robotoid is given exposure on a small scale first, to test its wings so to speak. For example, our alleged President goes fishing with a few friends or visits a farm family; but this had not yet been done with robotoid No. 6 on July 4, so that left the Russians no choice. The speech was canceled without explanation. The Jody Powell robotoid refused to answer reporters' questions. The press was stunned, Capitol Hill was shocked and dismayed, and Carter's own staff (those who are still human) were caught by surprise. The

following evening, July 5, the White House "Energy group" held a meeting. Afterward the Washington Star quoted a key Administration official as saying that, quote: "There was incredible disaster." Meanwhile Carter's political advisers supposedly were summoned to Camp David. By Friday evening July 6, Carter robotoid No. 6 was programmed and ready for initial controlled exposure. Thus began the so-called "Domestic summit" at Camp David. Fuzzled observers said they could not figure out what Carter hoped to accomplish with all this. The people invited to Camp David after all were people whose views were already known to Carter. Almost without exception, a number of the participants as they left scratched their heads in puzzlement. "Carter," they said, "had talked little. He simply sat taking notes and nodding most of the time."

My friends, two things were going on at Camp David: one was the controlled exposure I mentioned earlier for Carter robotoid No. 6; but in addition, key individuals among the visitors were robotized—that is, the real person arrived, but a robotoid departed!! The individuals who were robotized at Camp David had been identified from Nelson Rockefeller's "Hit List," which I discussed two months ago. Others were invited and left untouched as a smoke screen. All those of the List who arrived at Camp David are now dead—in their stead are robotoids carrying on in their places like programmed zombies. The people themselves are dead, and the robotoids are not conscious of being alive; and so the "Secret War of the Walking Dead" goes on.

On July 11, SKYLAB Day according to NASA, the Camp David "Domestic summit" ended abruptly. Carter robotoid No. 6 had started behaving erratically, Wall Street was rife with rumors that Carter had suffered a nervous breakdown, robotoid No. 7 was brought onto the scene, and the next day robotoid No. 6 was eliminated. Once again Carter was said

to be at work on his Energy speech. On Friday the 13th of July, journalists who met with robotoid No. 7 described Carter as, quote: "a thoroughly chastened leader"; others called him a deeply troubled and worried man. Nevertheless, the next day Carter robotoid No. 7 was sent forth to try his wings. Like a dead el cid strapped to a horse, the 7th robotoid copy of the late President Carter sallied forth. We were told that the President of the United States visited private homes via Pittsburgh, Pa., and Martinsburg, West Virginia. Afterward, the Russian Robotoid Command in Novosibirsk must have sighed with relief. One of the hosts told UPI, quote: "I feel better about him now. He is acting more like a president now." That Saturday evening July 14, Carter robotoid No. 7 arrived on the White House lawn by helicopter at roughly 6:30 P.M., but the Russians were taking no chances. An Associated Press dispatch that evening described another unexplained strange turn of events, quote: "Members of the Press corps who normally are allowed on the lawn to see and photograph the arrival, were barred from doing so on Saturday. White House Press officials gave no reason for the change except to say they saw no reason for the coverage." The following evening, Sunday July 15, Carter robotoid No. 7 successfully delivered the long-delayed Energy speech; but, as it turned out, Energy was only part of his subject. In that regard, the Russian program to nationalize the big oil companies was set in motion. That is what the so-called "ENERGY SECURITY CORPORATION" is actually all about; and to cut down all bureaucratic obstacles to Russia's "Energy plans" here, the "ENERGY MOBILIZATION BOARD" is to be created.

But the speech had a much broader thrust, dealing with the crisis of the American spirit. Some commentators have joked about the speech as, quote: "Carter's Sunday night sermon"; but as

I will point out briefly in Topic #3, we would be wise not to laugh because, my friends, the words of the Carter robotoid No. 7 came straight from the Kremlin, and the Kremlin is not joking. Even the speech itself was not without its mystery. The following day an article in the New York Times pointed out, quote: "Another extraordinary development was that the White House had no advance text of the speech, the President's ten days of deliberations notwithstanding. It was the first time in the memory of veteran reporters that no prepared text was released."

Even so, the speech gave the impression momentarily that things were finally back to normal, but that impression was shattered less than 48 hours later. Shortly after 4:00 P.M. July 17, the Jody Powell robotoid issued another brief surprise announcement to reporters. Something unprecedented had happened—the entire Carter Cabinet and all senior members of the White House staff had offered their resignations. Once again the Washington establishment was shaken to its foundations. But if the resignations were a shock here, they were a lightning bolt overseas, because in other countries the resignation of an entire Cabinet means just one thing—it means the Government has fallen. For the next few days news reports world-wide were filled with worried reactions. On all sides we were hearing words like Dismay, Bewilderment, Disbelief. Senators and others described Carter as acting erratically. One said publicly, quote: "We are worried about him having some kind of breakdown"; another said, quote: "I think the President is nuts."

FROM AUDIO LETTER # 51 (OCTOBER, 1979):

Topic #3--THE SURPRISE BOLSHEVIK DEPLOYMENT OF SYNTHETIC AUTOMATONS.

Topic #2--Five months ago I reported that Russia had begun deploying an astonishing new Intelligence weapon.

These are the "organic robotoids" -- artificial robot-like living creatures that simulate human beings. By introducing the robotoids, the Russians were able to make a shambles of the Bolshevik plans then in progress. Preparations were moving fast for a new Bolshevik revolution here in the United States, but the Russian robotoids stopped it cold. Even more importantly, the joint Bolshevik and Zionist Middle East war plan was thwarted, at least for the time being. This prevented the Bolsheviks from going ahead with the rest of their plan for an American nuclear first strike against Russia.

In AUDIO LETTERS 46 and 47 I reported that robotoid technology in the United States is far behind that of Russia, but now the Bolshevik and Zionist enemies of Russia have achieved their own surprise. The Rothschild interests, which control both movements, have for many years been deeply involved in biological research of all kinds. They have not succeeded in learning the secrets of the Russian robotoids, but they have achieved success with something similar. They are called "synthetic automatons" or simply "synthetics." A Rothschild synthetic is similar to a Russian robotoid in certain ways. Each is an artificial life form designed to simulate a human being, but synthetics also differ from robotoids in important ways. For one thing, they are generated by radically different techniques. Both utilize genetic samples from actual humans as their starting point, but beyond that everything is different.

The Russian process is a close relative of recombinant DNA techniques involving bacteria. The details of the process are shrouded in great secrecy, but it enables robotoids to be generated from scratch very rapidly. The Rothschild process, by contrast, does not start from scratch. Instead, certain tissues extracted from cattle are the starting point. The synthetic is then generated in a process that changed the genetic make-up in order to simulate

a person being copied. It is the outgrowth of a discovery made 20 years ago in France. The experiment involved two species of ducks called khaki Campbells and white Pekins. The landmark duck experiment of 1959 was reported in a book titled "THE BIOLOGICAL TIME BOMB" by Gordon Retray Taylor. It was published in 1968 by the New American Library, New York, N.Y. Taylor described the experiment in the words, quote: "They had extracted DNA from the cells of the khaki Campbells and had injected it into the white Pekins, thinking that just possibly the offspring of the latter might show some character derived from khaki Campbells. To their astonishment the actual ducks they injected began to change. Their white feathers darkened, and their necks began to take on the peculiar curve which is a mark of the khaki Campbell." Beginning with that clue of two decades ago, the Rothschild synthetic process has been developed in secret; and now, my friends, synthetics are beginning to appear on the scene.

Earlier this month on October 9, Carter robotoid No. 18 was scheduled to hold a news conference. Three days earlier, Brezhnev No. 2 had made his proposals in East Berlin for military reductions in Europe. Robotoid No. 18 had been programmed to react positively to the proposals, but instead our alleged President said, quote: "I think it's an effort designed to disarm the willingness or eagerness of our allies adequately to defend themselves." The Russians were dumfounded. This was a fresh robotoid, surely the recurring instability problem could not be showing up this fast! After the news conference, he was bundled off for examination and testing, and that produced the second surprise. It was not robotoid No. 18 at all, but a synthetic. The synthetic was then transported to Novosibirsk for further study. There robotoid scientists were able to establish an important and unpleasant fact: the

source of the genetic material used in generating the synthetic had been robotoid No. 18; and whereas the Russian robotoids vary somewhat from one to another, the synthetic was virtually identical in appearance to the missing robotoid No. 18. But an important favorable fact was also discovered—the synthetic is inferior mentally to the robotoids. It is not yet clear how fast the Bolsheviks will be able to deploy the synthetics, but the guerilla war between the Rothschild synthetics and the Russian robotoids is already beginning.

The Carter synthetic on October 9 was a shock to the Russians, and yet they have known for months that the synthetics would soon appear. For that reason, the Russians are beginning to re-emphasize their other weapons in their battle against the Bolsheviks here in America.

FROM AUDIO LETTER # 53 (JANUARY, 1980):

Topic #1—Four nights ago on Thursday, January 17, millions of Americans tuned in the ABC television program "20/20." The program that night presented a heavily-edited interview by the British television personality David Frost. The person interviewed was said to be the former Shah of Iran. The individual we saw on the David Frost interview looked, sounded, and acted very much like the Shah, but he looked much healthier than the sickly-looking Shah in New York two months ago. This was true even though news reports had been saying the Shah's condition was deteriorating. Almost every time he answered a question the face became expressionless, and the eyes froze into a glassy stare. He spoke slowly, haltingly, as if groping around in a fuzzy memory to find the answers. And time after time he just gave up and said simply, "I don't remember that."

Later that same evening ABC presented its nightly special on the Iran crisis. The program began with some follow-up discussion of the David Frost interview program. Dr. Joseph Sisco, former Under-Secretary of State, was among those asked for his reactions to the interview. Sisco appeared to be shaken by what he had seen. He said the Shah he knew had always been able to discuss the intricacies of geopolitics, not only as they affect the Persian Gulf but world-wide. By contrast, the man he saw on the David Frost interview was, quote: "Uncertain in his speech; a completely different man from the one I knew."

My friends, Dr. Sisco could not have been more right. The individual interviewed by David Frost in Panama was not the Shah at all. In fact, he was not even a human being. It was a kind of living robot, known as a "synthetic automaton," or more briefly, a "Synthetic." I first revealed last October 1979 in AUDIO LETTER No. 51 that Synthetics were beginning to appear on the scene. They are being deployed as a tool of intrigue by the warlike Bolsheviks here in the United States. They are the Bolshevik answer to another type of biological robot which the Russians began deploying earlier in 1979. The Russian type is known as an "Organic Robotoid," and I first made them public in AUDIO LETTER No. 46 last May. Both the Russian "Robotoids" and the Bolshevik "Synthetics" are remarkable creatures. They are manufactured by radically different technologies; but they have one thing in common—they are both artificial life-forms which live and breathe but have to be programmed like computers, and they are the products of three decades of spectacular scientific discoveries out of public view. I have given a little of the scientific background in AUDIO LETTERS Nos. 47 and 51, but Robotoids and Synthetics remain perhaps the most secret of all Intelligence weapons.

My friends, Dr. Sisco could not have been more right. The individual interviewed by David Frost in Panama was not the Shah at all. In fact, he was not even a human being. It was a kind of living robot, known as a "synthetic automaton," or more briefly, a "Synthetic." I first revealed last October 1979 in AUDIO LETTER No. 51 that Synthetics were beginning to appear on the scene. They are being deployed as a tool of intrigue by the warlike Bolsheviks here in the United States. They are the Bolshevik answer to another type of biological robot which the Russians began deploying earlier in 1979. The Russian type is known as an "Organic Robotoid," and I first made them public in AUDIO LETTER No. 46 last May. Both the Russian "Robotoids" and the Bolshevik "Synthetics" are remarkable creatures. They are manufactured by radically different technologies; but they have one thing in common—they are both artificial life-forms which live and breathe but have to be programmed like computers, and they are the products of three decades of spectacular scientific discoveries out of public view. I have given a little of the scientific background in AUDIO LETTERS Nos. 47 and 51, but Robotoids and Synthetics remain perhaps the most secret of all Intelligence weapons.

The instructions for growth are just 16 "genes," each a number controlling a feature of development. Scaling factor, for example, affects size, while gradients affect rates of growth of components.

In my previous tapes about these biological robots, I have mentioned that their most critical feature is their biological computer brain. In that regard, the Russian Robotoids are far superior to the Bolshevik Synthetics. That's because of their holographic brain, which I described in detail in AUDIO LETTER No. 47. LETTER No. 51 I mentioned the low brain

ORDER FROM:
Education Service Council
P.O. Box 271 • Elm Grove, WI
53122 U.S.A.
Dr. Befer Audio Letters ©

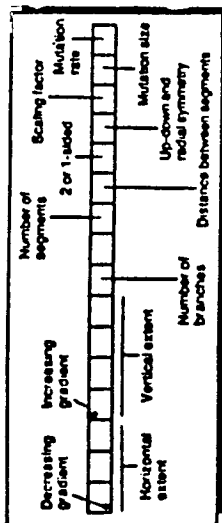

Other Sources of Data about Synthetics



A MAN OF PARTS

At first, photographers thought they had their negatives reversed. But no, Jimmy Carter had changed the part in his hair from the right side to the left. Ever attuned to subtle symbolism, the Washington press corps demanded an explanation. "Do you want a serious answer?" the President asked one reporter. "Well, I don't want to give you one."

Further digging revealed that Carter's tonsorial turnabout came a week earlier, during his vacation, and that not even First Lady Rosalynn Carter had noticed. Neither did her hairdresser, Eivind Bjerke, who has been trimming Carter's hair recently. "It's not an image-making idea," insisted White House image maker Gerald Rafshoon, after speculation that the shift was a Presidential cover-up for Carter's receding hairline. The change from right to left, Carter joked at the weekend, "is only for the primaries. For the general election—right down the middle."



(Reprinted from May 7, 1979 NEWSWEEK)

They are different from Clones.
ROBOTIDS ARE CREATURES WITHOUT SOULS
 (Not Human Beings)



This Awareness suggests that the robotoid does not have a complete development of soul, but does have certain spirit energies—this similar to what might be termed an elemental. This Awareness indicates these creatures in time can be perfected scientifically through other means whereby exact duplicates with potential for reproduction and human development could be made—this being closer to that which Jehovah created on Mars as Adam and Eve, and this as being closer to that which this Awareness referred to as synthetics. This Awareness suggests the synthetics live longer than robotoids, that the synthetics have been created by extra-terrestrials rather than Russians.



QUESTION:

That is correct. Organic robotoids, apparently having the facility to think like humans, must therefore have some form of life-force similar to that which motivates humans. Is that correct?

COSMIC AWARENESS:

This Awareness indicates this essentially correct—that these creatures do not have a self-awareness, except when this self-awareness is programmed into them. This as a kind of awareness similar to that of a plant, except when programmed to be self-aware. This Awareness indicates that the programming of behavior being that which is im-

planted into these creatures, according to the memory pattern from the predecessor. This Awareness indicates that the creatures themselves carry certain subconscious programmings similar to that of an entity who is in a kind of coma or zombie-like state. The entities' basic functions and basic responses carry through in the DNA cell memory, but the general programming of behavior and personality will occur from the implanting of the memory of the predecessor—this through the methods described by Dr. Beter in his June '79 tape.

This Awareness wishes entities to understand that throughout the universe creatures of this type exist in various places. This Awareness reminds entities of previous readings⁹ wherein it explained the experiments of Jehovah in the process of creating Adam and Eve. This Awareness indicates also in a reading given approximately one year ago, this Awareness released information regarding synthetics—these also are beings upon this earth created as doubles—this information released to certain key figures across this nation, was not made public because of the danger involved to the staff of C.A.C. and the Interpreter,

HOW TO IDENTIFY THE SYNTHETICS
WHO WALK AMONG US



YOUR PRESIDENT
Running . . .

(Associated Press/Amphoto)

This photo of the President of the United States, taken in August, 1977, as he jogs near Dubuque, Iowa, is not a Synthetic, but one of the many Robotoids created by the Russians. (This is Jimmie Carter Robotoid No. 6 and judging by his appearance is about ready for the creamatorium at the Russian Embassy in Washington D.C. Robotoids have a life span of only several months before they burn out). For more information on this please refer to the Audio Tapes of Dr. Peter Bear.

This Awareness indicates that these entities in appearance have, until last year in February (1977) have had certain types of characteristics that could be distinguished—that they showed no Adam's apple; they did not eat in public, for they have no need for food. They used pills, and when caught in a situation whereby they were required to eat, would eat only soup or light salad—a very small amount.

This Awareness indicates that these entities generally had a mottled skin, something like pizza crust. This Awareness indicates these entities often had a walk that was reminiscent of a penguin or duck, a kind of waddle back and forth. These entities as not being able to turn their necks very far and needing to turn their entire body, as though they had a stiff neck.

This Awareness suggests that the information being given presently not being given to allow entities to become paranoid and search out the synthetics in their midst and begin some kind of persecution drive, but as being given to allow entities to understand there is something occurring, and to assist them in being cautious in regard to who they are associated with.

This Awareness indicates that these entities themselves are slaves. The Bigfoot creatures are slaves, and those dwarfs and those entities beneath the ground known as Deros or detrimental robots, these also are slaves. This Awareness indicates those entities referred to as Men in Black, the MIBS, are also slaves. That all these entities are set up under that entity who has presented himself in the midst of the seat of power known as the Anti-Christ. This Awareness indicates this entity as having control upon this hierarchy system, intent upon gaining power and control of the earth, in order to set up his realm

SYNTHETICS CAN TELEPORT, CAUSE
ACCIDENTS, SICKNESS AND DEATH

This Awareness indicates that these entities have great power in terms of physical and occult controls. That these entities have machines which allow them to listen to the thoughts of others, which allow them to teleport; and whereby, even in vehicles, they can hook their teleportation machine to the vehicle and teleport, or disappear, right before the eyes of others. This Awareness indicates these entities have the ability to appear, to materialize, before others. This Awareness indicates that these entities have the ability to create pains and nausea and sickness in others. These entities as often causing accidents and death and illness to those on the surface, particularly when these entities on the surface level become too aware of their activities and become a threat.

SYNTHETICS BEING MANUFACTURED
IN MOUNTAINS ABOVE LAS VEGAS

This Awareness indicates that these synthetics as being created from an action similar to cloning, yet in part using certain flesh from animals or humans, particularly common is the use of the cerebral and nerve system of the cow. This Awareness indicates that these synthetics are put together and are indeed living creatures in which astral beings may enter to work through upon this physical plane. This Awareness indicates these entities also are capable of creating synthetics who look exactly like other living persons upon this plane. These entities being trained in an area in the mountains near Las Vegas, Nevada, given information regarding the person who they are to replace, given background, childhood experiences, memories, being given programmed memories of that childhood, and identification to allow them to slip in and fill the role of that person.

This Awareness indicates that often there are created sets of synthetics who are identical in appearance, but are placed in various areas so that they are not spotted or recognized as being the same person in two locations. This Awareness indicates these entities generally are operating from a rather obscure position in society whereby they do not call attention to themselves by their occupation, but these entities as generally having vast amounts of money. This Awareness indicates this as given to them before leaving the training area in Nevada — this at present as being approximately three to five hundred thousand dollars. This to allow them to mingle in society

The formative fields are used and manipulated to achieve desired effects during the process of creation of synthetic species and in the manipulation of other beings.

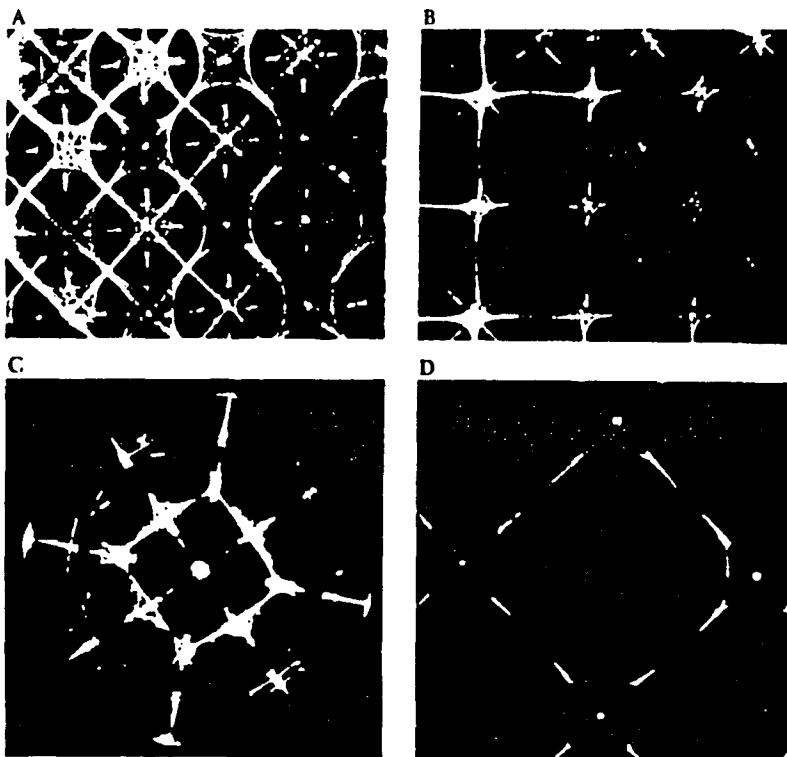

Cymatics, the study of wave forms, illustrates dramatically the relationship between frequency and form. Specific materials subjected to specific vibrations assume specific forms. A given form can only be summoned forth at its corresponding frequency; form is a response to frequency. Form is what we call 'reality' but that reality is obviously conditional — for it is the structure of our organs of perception that is responsible for the ultimate picture. If our senses were differently attuned, reality would assume a very different aspect. We might perceive matter as motion if our senses were quicker; if they were slower, we would be aware of the apparent motion of the sun, and our whole world would appear to be motion.

Vibration is an alternation between positive and negative poles. Metaphysically, it is a manifestation of the revolt of spirit against its imprisonment in matter. In Egypt, Ptah, creator of forms, is shown bound in mummy cloth.

Cymatics gives visual expression to 'In the beginning was the Word' — or more accurately, 'Verb'.

In A, B, C and D, oil of turpentine has been subjected to vibrations and the resulting pattern photographed. The pattern prevails throughout, and can be photographed on a microscopic level. E represents an electron beam subjected to two opposing magnetic fields.

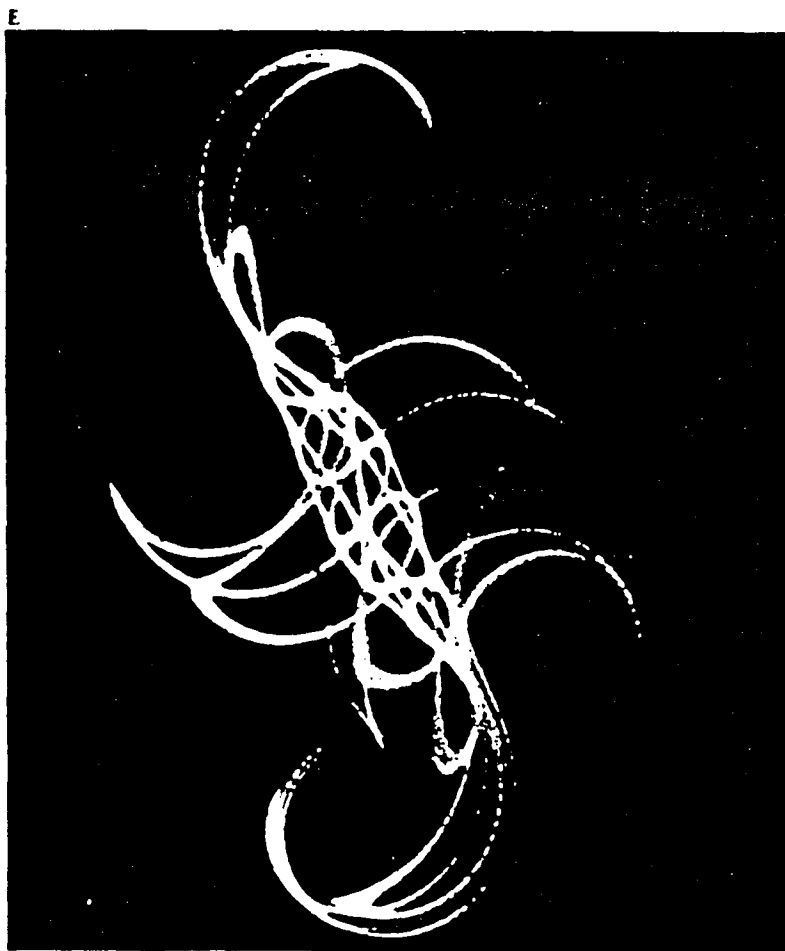

*CONVERSATIONS BETWEEN RESEARCHERS
On Synthetics and Clones*

- > In your opinion, do you think any of the material about the use of clones, synthetics and androids is valid?

- > Yes, there is plenty of evidence that these and other processes are carried out universally in order to permit the housing (or trapping) of consciousness. As far as western culture is concerned, there have been examples that have been shown to the public. For example, on the TV series "The Invaders", the title role was played by Roy Thinness. Shortly after Roy had finished reading for the series, two weeks before he was to start filming, he had a UFO encounter himself. It made the whole thing he was doing for the series a lot more real for him. As a result, he began to examine the different ideas presented in the series a little more closely, such as ways that the Invaders could be ID'd because of their stiff finger, etc. The government eventually forced the series off the air.

These beings that are coming from the other frequencies that don't use a physical body but need a physical presence have other beings that have a physical presence generate biological structures that function as containers for them. Biological humanoids.

Through these their energy fields are manifested. The internal organs would not matter, since they are just energy transitional containers. A lot of what is going on is like super science fiction. The only way a lot of humans can deal with it is through science fiction, because if they have to continually confront that it is real, or what they may have to think or do about it, knowing that it is a fact, it would evoke too much stress.

It is easier for most humans to negate reality to a science fiction format so they can manipulate the concepts while at the same time equating the fantasy as a sort of "protection" against the true nature of reality, which is suppressed by cultural forces in order to maintain organization and pacification in an artificially maintained cultural process of "Be silent, Consume and Die" in the midst of massive intentional suppression of awareness.

There is consciousness which has manipulated human beings for a long time according to what is, to humans, an alien agenda. It makes all personal agendas for humans totally worthless. The "game" is deeper and more complex than most humans can imagine; a lot deeper than a few humans having a little disk hardware at S-4.

The situation is that in a sense, humans are "spiritual warriors" only dealing with things in accordance with the perceived probability of success of dealing with them, while at the same time hoping that the other levels don't have to be dealt with until they have achieved the ability to deal with them. There are transformations that will take place in human society within the next two years that many humans will not have the capacity to deal with. These transformations

and processes are many of those that have been relegated to the perceived realms of "science fiction", and will occur in real-world density. The "I only believe in nuts and bolts" type of individuals will have to deal with these concepts. These next two years will be a sort of bizzare time compression.

As far as the human situation is concerned, most of the politicians have doubles. Even George Bush. A lot of technology discovered since the 1940's has been actively suppressed. There are all sorts of things that can be done to adjust a living being to look like something or someone else. Many hints of the technology have been seen in the media in old television programs like "Outer Limits" and in films.

There is a lot of truth in many of the old programs. Gene Roddenberry, creator of the Star Trek series, made several pilot films after the Star Trek series ran out. One of them was Genesis II, which portrayed United States Gov't underground genetics laboratories that were connected by tube shuttles. The pilot was never permitted to develop into a series, for obvious reasons.

There are other films that deal with biogenetic clones and still others that portray remotely piloted spherical surveillance objects that are controlled from underground laboratories. All these portray aspects of what has been actually happening.

The early programs in the "Time Tunnel" series portrayed the government having an underground lab that housed the time tunnel equipment. Access was by way of a piece of desert road that dropped down and allowed vehicles to drive underground in tunnels. Fantasy is coming from reality, not the other way around.

> How about events in the near future, in the 1990's?

> The psychic turn-around will really be significant. It has to do with the "nuts and bolts" type of people who do not believe in anything intuitive or spiritual, because these people will have to figure out what it means to them.

> Exactly.

> Now, what do you do with the hardware when the guys in the software department begin to manipulate the hardware? The intuitive people are starting to take over the hardware that the "nuts and bolts" people haven't got anywhere with. Now, people will have saucers...it will mean that the intuitive people will start dreaming up more things that they want done in "nuts and bolts", and we will start getting more bizarre expressions. All the stuff will start to manifest itself...force field enhancers, negative ion shields, etc.

> Do you have any more thoughts about human clones and doubles?

> I think there are human doubles.

> How about the clones?

> I think they can be fabricated to the height and age requirements that are necessary. I understand that some of the autopsies of the aliens demonstrated that some of them had a spongy sort of material inside -- the same material all the way through. There was a good example of this type of lifeform in the movie "Forbidden Planet". The lion and the other animals were not real animals, but biological things that were created through thought alone. Humans would be able to do that if their cerebral capacity was released - humans could do what some of the alien species require hardware to do -- that's why they are suppressed the way they are on this planet.

> Yes, that's true. When you stop to think about it, nothing in nature is created before it is needed or used. When this fact of nature is applied to the human using only a small percentage of brain power -- the fact that humans have been genetically manipulated becomes fairly obvious. There have been estimates that the human species has been manipulated at least 65 times during their presence on this planet.

> Well, when you go back to what Bob said - that he saw an autopsy of an alien and that it was spongy inside when it was cut open - what are we looking at -- we're looking at containers. The aliens have made reference to the fact that humans are containers that they do not want damaged - whatever that means. There are all sorts of containers that energy beings can use and manipulate. Some of the aliens may not be real aliens - in other words, you can't kill them. If you kill them, that means you damage the container. Now you have an unmanifested energy field until another container becomes available. The aliens manufacture biological containers for themselves. It is possible to obtain a cerebral holographic memory trace of a human being and insert it into a biological container. The late Dr. Beter had a lot to say about this.

> Creating the clone bodies or the doll bodies..

> Yes.

> So the Reticulans fall into this category?

> Yes.

> I would think that the United States Government could create them by the same process.

> A lot of abductees have indicated that they have in essence progressed to where they could fabricate their own bodies - using the biologicals gained from humans and cattle.

> Yes, and in essence they are a parasitic species. They have to

continue to look for biological materials, so they go for the cattle and certain glands out of humans.

> And cerebral holographic memory transfer?

> Absolutely. All you have to do is look at Richard Shaver and you can see that it is what he was talking about way back then. You can go back through history and you will find reference to crystal technology being used to implement this process. It has been going on here for at least 50,000 years.

> What else do we know about these artificial life forms? Do these artificial bodies have weaknesses?

> Well, they have a lot of inherent positive qualities. Remember, these beings know that they don't "die"; for them to die simply means the temporary inability to manipulate on a specific energy level - it is only a matter of frustration for them. Most of the time they are in a high energy plasma state; they are fields of force. They are coherent radiant beings. They have the ability to take over physical bodies and manipulate them.

> Isn't that what humans are, as well?

> Yes, yes, yes. But these guys know in a way that humans don't know.

> It all seems to go back to some of the things Hubbard was saying.

> Well, yes. That information he picked up through the O.T.O, Crowley, Blavatsky and the rest of them. Most of the human population doesn't want to know about this stuff - sheep who don't want to face it. They chose to be asleep. They chose to be sheep. Its a BIG game.

> How would you characterize the game?

> Levels of consciousness, again.

> Development of human abilities will start with development of visualization and memory and the various manipulations.

> Yes, one is called eidetic memory. It starts with the ability to maintain a visual image after the image is taken away. Everybody has this until they are untrained away from it.

> Maintaining visual images is the first step to manipulating energy. When energy can be manipulated in this way, you can affect these alien beings. Again, that goes back to some of the reasons why humans are suppressed. Once the aliens realize that you have discovered that energy follows thought and that you have control over it, you become a frustration to them - even a danger to their operations - they back off. You practice a little aversion "therapy" on them.

> Well, this kind of thing has been seen on the direct human level. It was going on before Nixon was elected. There were occult groups that were psychically attacking Nixon, trying to say that he wasn't going to last in office. This stuff was occurring about six months prior to Watergate. The occult groups, which were in Los Angeles, had no idea what his weakness was. They just decided that they were going to psychically attack him. They were doing it in groups of 12 and groups of 56 and larger groups.

The whole thing was, the intelligence agents could monitor this but they couldn't do anything. They tried to get together their own groups in order to attempt to counteract what these groups were doing and to learn how to counteract future activities of the same nature. The president had gotten his CIA groups together in an underground laboratory which was about seven levels down, past where they kept the disks, at Langley. This was actually occurring - trying to protect the President using occult rituals.

> So, what this is really illustrating is part of the connection between the occult and the "UFO phenomenon".

> Yes, every time you say "UFO" or "flying saucer", you are talking about things that are connected to the occult. All the occult groups had already had the whole thing of hypnosis, mind control, and little brain wave transmitters that only affected a town; those that GE later developed so that it would affect the entire planet. All the technology did was expand - the secrets of mind control and alpha generation, sympathetic harmonics and the rest of it was already here, and it has been passed on for a long time, perhaps 15,000 years. The information has been passed for generations in the Masonic orders. It has been very compartmented information for a long time, and these people would guard it to protect themselves. In one of the most popular religions in the midwestern US they have secrets that prompt self-policing and even murder of their own people.

> How would you characterize the current situation in the intelligence agencies?

> It is now so fragmented that they are fighting each other and someone is trying to coalesce as many fragments as possible in occult society....

> Who?

> I am afraid it is off-planet connected groups, because it's not just one. You have the Reptilians, the Draco, trying to consolidate their forces; you have the Nordic blonds, the fascist pure-bred humans trying to consolidate their factions, by saying "let's commit genocide" against the other guys. These guys are still trying to compete with each other. They are not working with each other.

They will eventually arrive at a spiritual realization when

they realize that they can't really kill each other, and they know that they can't kill each other - so they are going to have to come to some sort of agreement ---- that's going to ease up the pressure on all the rest of the "sheep".

> And when would that happen?

> Well, I think that will occur probably in 1999.

> That's we get the 4 1/2 dark years that we were talking about before.

> Yes, you are going to have your kick-ass dark years that are really bad, and then they come out with a thousand years of peace on the "agreement plan". Normal people are going to be left standing there saying, "what the hell happened?" The others are going to be psychically tormented because they are going to be in there battling in the conflict.

NOTES

MUTATION NOT INVOLVING CHANGE IN CHROMOSOME NUMBER

The term *mutation* may be used in a general sense for all types of alteration in the hereditary substance aside from that accomplished by normal meiosis and syngamy, the types being classified on the basis of the amount of the substance involved (gene; group of genes or section of chromosome; chromosome; chromosome set), and the nature of the process causing the alteration (Bridges, 1923). There is a tendency among some geneticists, however, to restrict the term to gene mutations.

Gene Mutations.—The hypothesis that the comparatively stable gene may under certain occasional circumstances undergo a qualitative change with an effect upon one or more characters underlies much of the genetic investigation now in progress. It is supposed that such an alteration may involve a single locus or gene ("point mutation") or a group of linked genes occupying a certain region of a chromosome ("regional mutation" or "complex mutation"). There is genetic evidence to show that gene mutations may occur at any place in the organism or stage of the life cycle, but they are most frequent in the germ cells at or near the meiotic period.¹ Ordinarily, therefore, only a few of the many reproductive cells transmit the altered gene. If, as seems to be true of the majority of known cases, the mutation is from a dominant to a recessive condition, the effect on the characters of the diploid organism will not be fully manifested until two such recessive allelomorphs are brought together.

Gene mutations occurring in body cells are known as *somatic mutations*. Two of the most conspicuous results of somatic mutation in plants are bud sports and chimeras. If the mutation occurs in the meristematic tissue of a very young bud, the entire product of the bud—branch, flower, or flower cluster—has a new genotypic constitution and exhibits an appearance often strikingly different from that of the other branches or flowers of the plant; hence the term "bud sport." Such a mutation occurring in a partially developed shoot or organ may result in a chimera, in which a distinct portion of the mature structure, commonly a sharply defined sector, differs constitutionally and in appearance from the other portions. Analogous changes occur in animals. Somatic mutations in the young pistillate inflorescence of maize result in colored areas of a size depending on the stage at which the change occurs. If it takes place at an early stage of development, the area may include a large portion of the cob and many kernels; if it occurs late there are only smaller spots on the kernels. Calculations have shown that these mutations occur with increasing frequency as maturity is approached, and that the increase is far greater than can be accounted for on the basis of the increased number of cells in which mutation might take place.

Such mutational changes are inherited only if they take place in the lineage of the reproductive cells. Many occur after the latter cells have been differentiated, or in parts of the plant which produce no such cells. Some pericarp mutations in maize which are not inherited are supposed to take place in the epidermis, which is developmentally distinct from the inner tissue in which the reproductive cells arise (Emerson). Likewise in *Datura* certain new characters manifested in the altered color of petals but not transmitted through the seeds are attributed to epidermal mutations. Similar mutations occurring in subepidermal tissue and not at once affecting the petals may be revealed in the petals of the next generation, since all the tissues of the plant, no matter how distinct from one another they may be during the later developmental stages, arise from the same zygote.

By some geneticists somatic mutations have been thought to be due to the segregation of two heterozygous allelomorphs in vegetative divisions; the recessive gene, thus freed from the dominance of its allelomorph, is then able to produce its characteristic effect upon the tissues. This explanation appears plausible in the case of recessive mutations, especially since a non-separation of daughter chromosomes has occasionally been observed in somatic tissues; but it will hardly account for mutations from the recessive to the dominant condition, which have frequently been observed (e.g., in maize pericarp by Emerson, and in the elytra of *Bruchus* by Breitenbecher, 1922). The hypothesis of gene mutation is in better accord with the sum of the evidence.

The nature of the mutational change which may thus occur in the gene is unknown, since the nature of the gene itself is almost wholly a matter of conjecture. The literature of genetics contains many interesting speculations on this subject, various comparisons with molecules, radicals, colloidal aggregates, and enzymes being suggested. Whatever its nature, the gene appears to have a high degree of stability, and is not easily influenced. So far almost nothing is known about the causes of gene mutation, although the effects of temperature (Krafska on *Drosophila*, 1920) and anti-lens serum (Guyer and Smith on rabbits, 1918, 1920) appear to be of considerable significance in this connection. The stimuli to which the genes respond by undergoing some constitutional change are probably for the most part internal ones. Although the number of ways in which a gene may change is limited by its own organization, the possible changes are nevertheless numerous; and it is very probable that a large share of the variations which constitute initial steps in evolution originate in this manner.¹

Triploids.—Triploid species, varieties, or forms are, like tetraploids, of fairly common occurrence among plants, and they are also known among animals. The *Cenothera* mutants of the *semiparas* group have 21 chromosomes instead of the diploid 14. Triploid roses also have 21. Triploidy occurs occasionally in *Drosophila*, and has led to significant results in the study of sex and other characters (Bridges). The interesting cytological behavior in forms with an odd number of chromosome sets will be discussed later.

Other Multiples.—In addition to the foregoing categories, there are found many examples of higher multiples of the basic haploid number. In the genus *Rosa*, for example, pentaploid, hexaploid, and octoploid forms are known, as well as diploids, triploids, and tetraploids (Täckholm, 1922). Decaploids are known in *Chrysanthemum* (90 chromosomes; Tabara, 1915b, 1921) and in *Papaver* (70 chromosomes; Ljungdahl, 1922). In *Senecio*, which has 5 as its basic number, Afzelius (1924) reports one species with about 90 chromosomes.

It is a very significant fact that a considerable series of multiples may occur within a single family or genus. In *Chrysanthemum*, for example, there are species with 9, 18, 27, 36, and 45 pairs of chromosomes. In a large number of species of *Senecio* and related genera the numbers are nearly all multiples of 5 (Afzelius, 1924). Mention has been made of the similar series in *Rosa*, in which the basic number is 7 (Fig. 178). In *Triticum* the diploid numbers are 14 (Einkorn group), 28 (Emmer group), and 42 (Spelta group) (Sakamura, 1918; Kihara, 1919; Sax, 1921, 1922) (Fig. 185). In the Compositae three series of genera may be distinguished with basic numbers of 4, 5, and 9 respectively (Rosenberg, 1917). Many other similar cases might be cited.

The bearing of such "euploid series" of chromosome numbers on the problem of the differentiation of species and varieties will be discussed later. It may here be observed that species groupings made on the basis of chromosome number frequently correspond strikingly with those arranged by taxonomists on other grounds. A good example is seen in the genus *Triticum*.¹

Haploids.—Haploid mutants, though obviously not polyploid, may be mentioned here. The appearance of haploid individuals among organisms normally diploid is a very rare occurrence. It has already been pointed out how frequently such organisms show a peculiar inability to proceed very far in development with only one set of chromosomes (p. 360). In *Datura stramonium* Blakeslee and his associates (1922) discovered the first known case of a haploid angiosperm sporophyte. Several such plants have now been obtained by these workers. They are somewhat weaker than normal diploids, but grow successfully to sexual maturity. Clausen and Mann (1924) report the discovery of two haploid plants among their *Nicotiana* hybrids.

Aneuploidy.—Aneuploid forms (Täckholm, 1922) are those having somewhat more or somewhat less than a euploid (usually the diploid) number of chromosomes, but not a multiple of the basic haploid number. It is of interest that such forms usually differ in appearance from the normal diploid much more than do the tetraploids, triploids, or other euploid forms. Apparently there is a "balance" within the complement which is maintained even when three, four, five, or more haploid sets are present, but which is disturbed when any set lacks one or more chromosomes or has them present in excess. Such disturbances in the normal ratio of inheritance elements caused by the addition or loss of chromosomes or sections of chromosomes are called "ratio mutations" by Bridges (1923). Aneuploids with extra chromosomes ("hyperploids," Winkler) are of common occurrence, but the corresponding "hypoploids" are comparatively rare; the loss of a chromosome seems to cause a more serious "unbalance" than does the gain of one. The best-known aneuploids are those with one more than the diploid number—the $2n + 1$ forms, exemplified by *Cenothera lala* and certain *Datura* mutants.

In the *Cenothera* mutants of the *lala* group there are 15 chromosomes rather than the normal 14; one of the chromosomes is present in triplicate while the rest are in duplicate as usual¹ (Fig. 177, C). Lutz found mutants of several types in this 15-chromosome group, which suggested that the chromosome present in triplicate was not always the same member of the complement. In *C. scintillans* Hance (1918) was able to distinguish the extra chromosome by measurement.

Cytoplasmic Mutations.—Under the head of mutational changes not involving changes in chromosome number may be included those little-understood cases of alteration of cytoplasmic constitution which show themselves in the plastids (p. 417). It is only in a broad sense that these can be called "mutations." Reference has been made to the uncertainty regarding the rôle of the nucleus in such cases, and at present it seems best not to confuse them with mutations clearly involving the chromosome mechanism.

Chromosome Aberrations Not Affecting Number.—Mention may also be made here of certain mutants whose chromosome complements comprise normal numbers but abnormal assortments. Thus in certain aberrant types of wheat Winge (1924) observes that the chromosomes are present in the normal number, but include a trisome or tetrasome along with the paired members. This is taken to mean that one or more chromosomes have been lost through non-disjunction and replaced by others not homologous with them, the genic complex and hence the external appearance being altered. Similarly, in tetraploid *Datura* Blakeslee and Belling have found a modified type in which a lack of one chromosome is offset by an additional chromosome of another kind; the number of chromosomes is normal ($48 - 1 + 1 = 48$), but the make-up of the complement is abnormal.

Such cases serve admirably to illustrate the important point that chromosome number, although it affords a convenient basis for classifying the many types of mutants, is not the feature upon which attention should be centered. The fact of prime significance is that chromosomal aberrations with an influence on the organism's characters involve *qualitative alterations in the genic system*. Such changes can frequently be detected in comparisons of the size, shape, and arrangement of the chromosomes of the complements in question. Although numerical differences, when present, are important, it is obvious that chromosome complements may vary widely in constitution irrespective of such easily observable differences.

MUTANTS AND HYBRIDS WITH CHANGED CHROMOSOME NUMBER

New types appearing spontaneously with altered chromosome numbers are usually referred to as mutants. Since, however, they in many cases exhibit chromosomal aberrations like those observed in hybrids, and frequently show many of the other characteristics of hybrids, such mutation and hybridization are doubtless very closely related phenomena. They may therefore be treated together.

Polyploidy.—Polyploid forms are those possessing more than two complete homologous sets of chromosomes in the nucleus. When the total number is thus an exact multiple of the fundamental haploid number the term *euploid* (Täckholm, 1922) may be employed.

Tetraploids.—In a tetraploid individual there are four chromosomes of each kind, rather than two as in a diploid. For some time the best-known examples of tetraploidy were the *gigas* mutants of *Oenothera*, with 28 chromosomes instead of 14 in their somatic nuclei (Fig. 177). Tetraploid species or varieties are now known in many genera. Typical examples are *Primula kewensis*, with 36 chromosomes instead of 18 (Digby, 1912; Dahlgren, 1916), several species and hybrids of *Rosa*, with 28 instead of 14 (Täckholm, 1920, 1922; Blackburn and Harrison, 1921; Penland, 1923), and *Datura*, with 48 instead of 24 (Blakeslee, *et al.*).

Tetraploid mutants are frequently characterized by an unusually large size, not only in the plant as a whole but also in its anatomical constituents (Winkler on *Solanum*, 1916; Tupper and Bartlett on *Oenothera stenomeris*, 1916). This, however, is not always true. Moreover, not all cases of gigantism are associated with tetraploidy: in a form of *Primula sinensis* (Gregory, 1909, 1914) and in *Phragmites communis* (Tischler, 1918) it is associated with an increase in the size of the chromosomes but not of their number. Sinotó (1925) reports that in *Plantago japonica*, a giant form, the number of chromosomes (12) is only one-half that in the ordinary *P. major*, var. *asiatica*. Although the volume of the nucleus is less in *japonica*, the cell size is about the same in the two species; the cells are accordingly more numerous in the larger species. It has been suggested by Blakeslee, Belling, and Farnham (1923), as a result of their studies on *Datura*, that in tetraploids with four homologous chromosomes assorting at random, a change may occur whereby they behave as two regular pairs (the "double diploid" condition); or even that the like chromosomes conceivably may fuse in pairs, giving the diploid number of larger chromosomes, as in *Primula*. Only future research can show whether or not such changes actually occur, and what effect they may have upon the expressed characters.

The mutants of *Datura stramonium*, investigated by Blakeslee, Belling, and their associates, represent the most fully analyzed cases of aneuploidy in plants. In *Datura* the haploid set consists of twelve chromosomes: one very large, four large, three large medium, two small medium, one small, and one very small. Haploid mutants have one such set, normal diploids have two, triploids have three, and tetraploids have four. In addition to these euploids, a considerable series of $2n + 1$ mutants has been found; and it is noteworthy that the number of primary types of such mutants is 12. Since this is the basic chromosome number, each of the 12 primary types would seem to be due to the presence in triplicate of a particular one of the 12 chromosomes, and there is much genetic and cytological evidence to show that this is actually the case. Such $2n + 1$ forms are called "simple trisomic" mutants; they have 11 disomes (normal pairs) and one trisome. Other modified diploids are also known: "double trisomic" forms have two of the chromosomes in triplicate ($2n + 1 + 1$); "simple tetrasomic" forms have one of the chromosomes in quadruplicate ($2n + 2$); and so on. Modified tetraploids and triploids are also known. A $4n + 1$ form is called a simple pentasomic, and a $4n - 1$ a simple trisomic type.

The unbalancing effect of extra chromosomes is well illustrated in the "globe" mutants, which are due to an excess of a certain one of the 12 chromosomes. It is found that the $2n + 2$ globe has the characteristics of this mutant more accentuated than the $2n + 1$ globe, and the same is true of the $4n + 2$ as compared with the $4n + 1$ forms; in each case the degree of nuclear unbalance is reflected in the somatic appearance. It has furthermore been found that the 12 primary $2n + 1$ mutants differ not only in their external appearance, but also very characteristically in the details of their anatomical structure (Sinnott and Blakeslee, 1922). Under each primary type various secondary types may be recognized; these seem to be due to different arrangements of the elements of the trisome. Blakeslee and Belling (1924b) have recently reported several "chromosomal chimeras," in which single branches on diploid plants show $2n - 1$, $2n + 1$, or $4n$ chromosomes. It also seems probable that epidermal and subepidermal tissues may sometimes differ in the same manner.

As in the case of euploid numbers, aneuploid numbers seem to arise in mutants are found also in the varieties or species of certain taxonomic groups.

CHROMOSOMES AND SPECIES ALTERATION

The discovery of the relative uniformity of the number of chromosomes in an individual or species led to the determination of the number in many organisms belonging to all of the major groups. A certain amount of speculation regarding the general phylogenetic significance of chromosome number has been indulged in, but students of the subject have reached the conclusion that the data at hand do not warrant many broad generalizations. So far as the large groups are concerned, there appears to be no correlation between taxonomic position and structural complexity on the one hand, and the number, length, width, or volume of the chromosomes on the other. But it is generally agreed that within restricted circles of affinity the number of chromosomes, as well as their size and form, may often afford important evidence in the determination of genetic relationships.¹

This latter conclusion is strongly suggested by the fact that such euploid and aneuploid numbers as are seen to characterize mutants arising in cultures of diploid plants are found also in the several varieties or species of certain genera and families. Attention has above been called to the remarkable euploid series in *Chrysanthemum*, *Rosa*, *Triticum*, and other genera; here the related species in each genus exhibit various multiples of some fundamental haploid number of chromosomes. In other groups aneuploid series are found. A conspicuous example is the genus *Carex*, in which the species examined show 22 chromosome numbers, all but one of which lie between 9 and 42 (Heilborn, 1922, 1924) (Fig. 179). Taxonomic relationship is here clearly reflected in the number and size of the chromosomes.

It is a striking fact that polyploidy is much less prevalent among animals than among plants. Although triploid and other polyploid individuals are frequently encountered, animal cytologists have found comparatively few cases in which related species or varieties differ regularly in the number of their basic chromosome sets. This situation is not fully understood; but one of the chief reasons for the rarity of polyploidy in animals appears to lie in the fact that in them the sexes are usually separate, owing to the operation of a mechanism whereby sex factors are segregated in meiosis and combined in syngamy, whereas plants are very commonly monoecious, sex in such organisms not being so closely dependent on chromosome distribution (Muller, 1925).

Example of how Chromosomes can change Characteristics

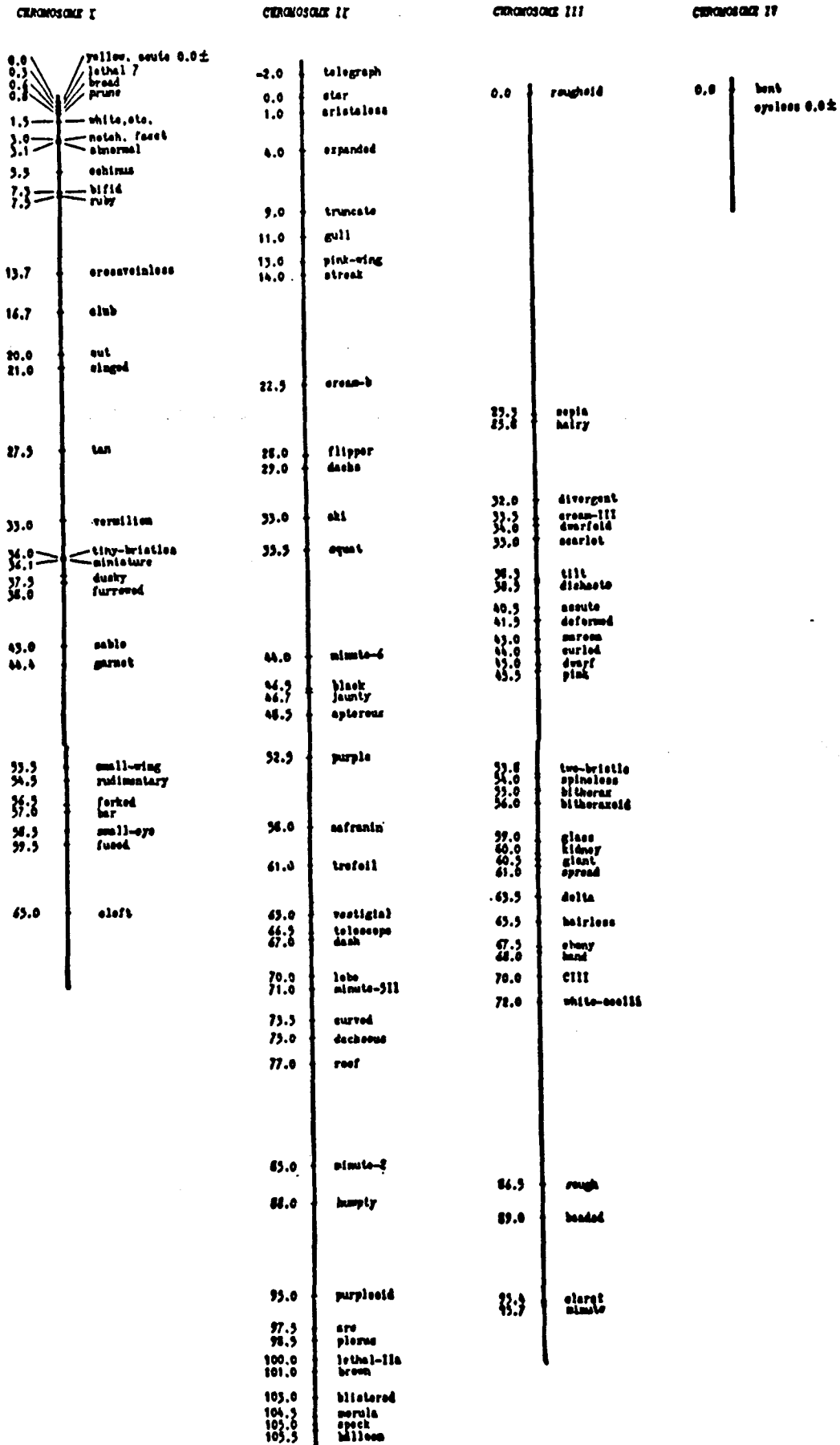

The chromosome map of *Drosophila melanogaster*, showing the loci of the genes as determined by Morgan and his associates.

Computation and biology mix in search for life's secrets.

By JAMES GLEICK

No longer content with dissecting tissues, analyzing proteins and breeding fruit flies, an increasingly diverse group of scientists has decided that the best way to study life is to make some of their own.

They are creating a field called artificial life, mixing the impulses of biology with the tools of computation. By looking beyond the usual materials of life — beyond the familiar biochemistry of earthly animals and plants — they hope to capture its spirit: the animated, the energetic, the replicating, the evolved.

Most of the would-be organisms of artificial life exist solely in the electronic environment of the computer, where they have little danger of being confused with the real thing. The first conference on artificial life, held last week at Los Alamos National Laboratories, offered models of processes from protein formation to plant growth to animal predation — processes meant to be, if not life, then at least life-like.

The simulations of biology address some of the most troubling questions of the life sciences: how the primitive precursors of DNA gained the ability to store information and copy it; how the senseless force of natural selection created structures of such extraordinary complexity and beauty; how the laws of ecosystems arise from the whims of individual animals.

They also reflect an expanding sense within science of what life is. Artificial life seeks "the ghost in the machine," as the conference organizer, Christopher Langton of Los Alamos, put it — an essence arising out of matter but independent of it. For the

first time in generations, some researchers believe, science has a legitimate way of talking about life's soul.

"It lies in the complexity of organization," said Richard Dawkins, an evolutionary biologist at Oxford University. "It's not a substance there's nothing material. It's just an incidental fact that in real living things, the entities that happen to be organized happen to be made of organic soft squishy stuff, whereas in a computer, they're made of hard non-squishy chips."

The creatures of artificial life already make up a strange menagerie. There are flocking birds and schooling fish just a few generations removed from the cartoons of Walt Disney. Invisibly bugs breed and die out as they leave trails through a mound of electronic food. Computer flowers bud and unfold, their timing controlled by computer chemicals running up and down computer stems. Stick-figure shapes evolve in a few dozen generations into startling butterflies and shellfish.

Some simply imitate real organisms. Most, however, depart from reality to capture some abstract quality of living things, preferably a quality that arises not from the designer's intent but from unplanned processes.

"What Is the Soul?"

"What keeps me awake at night is not correspondence to reality," said Steen Rasmussen of the Technical University of Denmark. "I want to know what is the soul in this that creates order — what is the engine."

Stripped of bone and sinew, leaf and petal, ribosome and chromosome, life still has a unique logic that can be abstracted in a computer — that, at any rate, is the belief driving the new discipline. Nor is the computer essential. Some scientists are trying to create microscopic carriers of information in fragmentary protein strands or pieces of

clay crystal. "Surely there must be a more general sort of biology," said Graham Cairns-Smith of the University of Glasgow, author of "Seven Clues to the Origin of Life." "This is the aeroplanes-don't-have-feathers principle. Yes, birds have feathers and fly beautifully, but we have different requirements."

Those explicitly seeking to create life, within a computer or a test-tube biochemical system, form a group that now brings together microbiologists, evolutionary theorists, physicists, chemists and computer scientists. At Los Alamos, they spawned rooms full of computer demonstrations, wandered from place to place wearing buttons asking "What is a genetic algorithm?" and showed videotapes of robots taking five hours to weave across a room.

They face a problem of definition. Most modern biologists think of an organism's abilities to process matter and energy, to replicate itself and to evolve as the essential, defining qualities of life. Some computer models already have those abilities, in more or less trivial ways.

So scientists debate the question of how they would recognize a genuine artificial creature if they had one. After one particularly testy exchange, a scientist proposed that a key criterion should be "irritability." Others recommended purposefulness and unpredictability as qualities any good organism should have.

Gerald F. Joyce of the Salk Institute in San Diego suggested the biologist test: put the artificial organism into a room with a biologist. If the biologist comes out and says it's alive, that would be encouraging.

"And if your organism comes out and says it's alive, then you're on the right track," Dr. Joyce said. Many of their colleagues will accuse those promoting artificial life of over-optimism

and exaggerated claims, particularly about the capabilities of computers. They remember the over-selling of artificial intelligence in the 1970's, and the Los Alamos conference, too, drew a healthy contingent from what one biochemist, Hyman Hartman of the University of California at Berkeley, called the "computers-are-the-next-*Age of Life* school."

Striking Patterns Emerge

Dr. Hartman warned against relying too blindly on computer models. As his own model undulated and sparkled hypnotically on the giant screen behind him, he told the audience, "One of the great dangers of artificial life is that you can be very, very clever and invent beautiful machines that do beautiful things, but you've gotten very, very far away from what you're trying to understand."

His simulation, a checkerboard of 65,000 cells that changed color according to simple rules, was meant to show how simple processes on the surface of a clay crystal might generate complexity. Indeed, as in several other demonstrations, strikingly rich and irregular patterns arose — large-scale structure emerging from the interplay of small-scale rules.

The recognition in recent years that complexity can arise spontaneously from simple systems gives the field of artificial life its strongest motivation. The scientists agreed that the most promising demonstrations were those whose lifelike qualities emerge unbidden, surprising even their programmers.

They want to play god, but not a god who directs the motion of every sparrow, as Dr. Langton said. "We don't want to do that — no global controller," he said. "And no miracles — miracles aren't allowed except at the very beginning."

A computer graphics expert

law Prusinkiewicz of the University of Regina in Canada — the winner of an "Artificial 4-H Contest" for most lifelike organism at Los Alamos — mimicked the growth of a variety of flower species. It combined geometric instructions with a set of timing signals, like the chemical signals that real plants use to control branching and budding. The results were vivid images of plant growth.



trying to create a flock of birds that will fly convincingly around obstacles, for example, must create a free-flowing yet tightly coordinated pattern of motion. Instead of programming a flock from the top down, Craig W. Reynolds of Symbolics Inc. let each of hundreds of imaginary birds follow a set of rules for avoiding their neighbors.

A natural-looking flock took shape, sweeping gracefully but not rigidly around blocks and cylinders. And unexpected behavior emerged as well — one bird crashed into an obstacle, fluttered in a momentary daze, and then staggered onward.

The spontaneous emergence of organization is a central problem of life at all scales. Those studying the origin of life are acutely aware that, without some self-organizing principle, it would take many times the age of the universe before chance would bring amino acids together in just the right combinations necessary to form the elaborate machinery of DNA.

Self-organization must also guide the combination of embryology — the unfolding of individual creatures according to the rules of development built into their genes — and evolution. These remain deep mysteries, and computer models are intended to show not how they do occur, but how they might plausibly occur.

Scientists have discovered in recent years that some seemingly complicated patterns, like the branching, jagged structures of plants, have simple descriptions in the language of fractal geometry, in which patterns are built up from rules repeated on different scales. No one knows just how such rules are encoded in the genes of real plants; nevertheless, several demonstrations at Los Alamos created lifelike ferns, trees and even flowers from relatively modest fractal instructions.

Elite Life Extension - A Hint Becomes Public in 1985

In the newspaper SPOTLIGHT, August 5, 1985, there appeared an article about the strange tendency for high officials to change appearance and seemingly grow younger:

" A SPOTLIGHT reporter who traveled from New York City to California last month was on the trail of reports that leading public figures are clandestinely availing themselves of revolutionary medical technology designed to prolong youth and lengthen life....rumors that elite personalities in entertainment and politics occasionally vanish from public view to "rejuvenate" themselves gained new currency when Jeane Kirkpatrick disappeared for a month-long "vacation" after her resignation as UN ambassador earlier this year. She reappeared in a blaze of publicity looking a full 15 years younger....knowledgable sources say she went through extensive regenerative therapy at an exclusive clinic in Mexico...a survey found that this new branch of medicine is making substantial strides - in fact, amazing advances - which are often kept Confidential..Reagan, Kissenger, David Rockefeller, Edward Kennedy and Billy Graham are some of those who have taken advantage of this technology....the drug most often mentioned by experts is Hydergine, developed by the Swiss medical firm of Sandoz....the next generation can look forward to becoming the first bionic people in history."

NOTES

Asteroids called threat to planet

Knigh-Ridder News Service

WASHINGTON — A leading group of space scientists, with the endorsement of Vice President Dan Quayle, is calling for an international effort to hunt down and destroy — perhaps with nuclear weapons and modified "Star Wars" gear — asteroids headed toward Earth.

"Earth orbit-crossing asteroids clearly present a danger to the Earth and its inhabitants," the American Institute of Aeronautics and Astronautics said in a position paper distributed Monday. "Although no fatalities have yet been recorded as a consequence of such events, the impact of even a rather small object would have a devastating effect on humanity."

Quayle, chairman of the National Space Council, recently supported the institute's initiative.

"In 1965, a small asteroid exploded high over Canada with a force equivalent to an atomic bomb," he told the group's annual meeting on May 1. "It would certainly benefit all nations to know when such a natural event might occur, warn those who could be affected, and, maybe someday, even affect whether and where such an event might happen."

The institute recommends that an international group of astronomers, aided by military satellite-tracking equipment, search the skies for asteroids and track their orbits so any collisions can be anticipated and then prevented.

"If we know where they are and know where they're going, then maybe we'll have time to do something about it," Jerry Grey, director of the institute's science and technology policy, said Monday. "A missile with a nuclear warhead would do it fine."

Asteroids are extremely small planets that circle the sun, largely between Mars and Jupiter. There are about two dozen asteroids more than 100 miles across and thousands more than five miles wide.

Scientists estimate that as many as 1,500 asteroids travel in orbits that cross the Earth's path around the sun, although the locations of fewer than 100 are known.

The last major asteroid to come close to the Earth passed within 400,000 miles — nearly twice the distance between the Earth and the moon — in March 1989.

Asteroid watch urged

Associated Press

WASHINGTON — It's the kind of stuff of which movies are made.

A mountain-size boulder from outer space is on a collision course with Earth.

Feuding countries put aside their suspicions and launch nuclear missiles to break up the asteroid and save the planet.

It works and everybody hugs everybody else.

Except for the last part, that's a scenario being proposed by the American Institute of Aeronautics and Astronautics.

Although asteroid orbits rarely intersect Earth's, the institute thinks scientists should be ready for one that might.

"We have the technology needed to detect and track such an object and possibly to divert it from an impending impact," the institute said. "We would be derelict if we did nothing."

In a position paper, the institute suggested that searches of the heavens be increased, perhaps by spotting relatively inexpensive telescopes around the globe.

It also called for a study of ways to "deflect or destroy, or significantly alter the orbits of, asteroids predicted to impact the Earth."

Asteroids are rocky bodies that orbit the sun between Mars and Jupiter.

The ones that have been observed range in size from 930 kilometres in diameter down to about 213 metres (700 feet).

Some have struck Earth in the past.

Only last year, an asteroid bigger than an aircraft carrier and travelling at 74,000 km/h passed within 640,000 kilometres of the Earth — a distance less than twice as far as the moon.

That asteroid missed slamming into Earth by only six hours.

Editorial Note

The occurrence of these press releases seems to support the recent information about an approaching planetoid. The planetoid has generally been described in the following concepts:

- (1) Wormwood
- (2) Draconian Planetoid harboring Reptilian Humanoids who are returning to Earth after an absence of hundreds or thousands of years - years during which the Greys gained the upper hand in the harvesting of the planet for biologicals and natural resources.

The new series "V" coming the the fall of 1990 is going to feature Reptilian species coming back to Earth

- (3) Invaders that will draw specific categories of humans from the planet during an upheaval come from the approaching planetoid.

National Security Intelligence Directive (NSCID) No.7

This directive gave the Central Intelligence Agency powers inside the United States to question Americans about their foreign travels and to *enter into contractual agreements with American Universities* (even though the National Security Act of 1947 forbid the CIA to exercise any "police, subpoena, law enforcement powers, or internal security functions"). This NSCID was the main basis upon which the CIA engaged in Mind Control research and other negative activities which reflect the mind set of the CIA's origin: Nazi SS intelligence.

National Security Intelligence Directive (NSCID) No.6

This directive details the functions of the National Security Agency (NSA), which itself was created by Executive Order. In the Nixon administration's 1970 secret plan for domestic espionage there is a recommendation that NSCID No.6 be revised to allow NSA "coverage of the communications of United States citizens using international facilities"; this is the source for the NSA's current practice of monitoring all international communications. During this process, a series of "keywords" are used. Whenever a keyword is spoken by a party on a telephone line, for example, a system is activated where the entire conversation is recorded.

Some of the keywords are believed to be: CIA, NSA, FBI, alien, UFO, president, etc.

A Fourth Branch or a Fourth Reich?

There is no Bill of Rights without *Constitutional Law*. George Herbert Walker Bush was a half sentence away from an open takeover: "Yesterday we [the C.I.A.] had a dictator in Panama..." Today we have a dictator in America.

The Constitution is the fundamental law of the land. All other legislation is inferior to it. Yet, statutory classification law has been elevated to the point of obstruction of justice and the War Powers Act was used to allow another unilateral Executive Branch military action without the advice and consent of the Senate, without calling a joint session of Congress so that the people could participate in open public debate. There was no emergency. It was a blatant act to serve the ends of the intelligence community in which both the State Department and the U.S. military, intended only for defense, were used offensively. The orders from civilian Bush sent off young Americans into combat unconstitutionally—*Congress shall declare war*—while he went off to enjoy his holidays. Americans listened to government propaganda and celebrated Christmas—*blessed are the peacemakers*—while innocent Panamanians were bombed in their beds at night.

A generation of discretionary funds, bloated bureaucracy, and militarism unbalanced the checks to the Executive Branch which is no longer a one line budget item but is able to make its own wars without any public discussion. [*Bills for raising revenues shall originate in the house.*] The republic has also been unbalanced by media governance in which commercial television's trained consumers are emotionally manipulated and then polls are purchased to silence the informed electorate and justify illegal acts subverting the rule of law. The couch potatoes do not know a republican from a fascist. After a decade of "support the President," media and celebrity images, they cannot tell a real man from the Wizard of Oz or a presidency from a covert directorate.

As the State Department and Defense Department just became tools of the secret government, the checks and balances were carefully dismantled—the Senate is a rubber stamp, the courts have been packed and the opposition party and IMPEACHING BODY neutralized. The *Farewell Address* speaks of the destiny of nations. That is the fall of republics to dictatorships. Mussolini took over with the help of a shrewd jurist. Hitler took over claiming a communist conspiracy.

It is amazing the number of WWII veterans who fought but cannot identify fascism. How did our civil republic get so militant? The bottom line is the *National Security Act* (1947). It was, is, and ever

shall be unconstitutional. We cannot be an open and a secret society. Secrets are not open contract and cannot be dealt with in either the civil or criminal courts. Any good encyclopaedia can outline the growth of spying and its subversion of open diplomacy and government under "Intelligence and Counterintelligence." These were wartime expedients that instead of being disbanded were perpetuated, keeping alive the *Esse* of the 3rd Reich in the development of their mad dreams of weapons for mass destruction and world control. Any good encyclopaedia can also outline the worldwide spread of fascism—all the way to Japan—and the propaganda techniques used. If it's not labeled a war, you cannot defend yourself but are called a terrorist.

The Constitution says all expenditures from the U.S. Treasury shall be made public from time to time. American taxpayers have never had an open accounting on the activities or expendi-

That small percentage of regular, registered voters must alert their representatives at all levels of government, that the Constitution must be enforced and that the people are exercising the limits to power by elected leaders who swore to "preserve, protect, and defend" it.

tures of the fascist underbelly created by the *National Security Act* which is now not "seeing that intelligence is properly communicated within government" but is using it, exclusively, for the secret agendas of the Executive Branch. The Congressional oversight committees have been purged and silenced. Usually, a Democrat is obtained to trot out on national television with the claim that the latest breach of Constitutional Law is bipartisan. In 1984 newspeak that means a Quisling Republic making the one party necessary to the fascist state. Now the breach of peace and the Nuremberg Principles are not being enforced against individual men conspiring to war and using nationalism to justify MURDER, MANSLAUGHTER AND CIVIL AND HUMAN RIGHTS ABUSES AS WELL AS DESTRUCTION OF PROPERTY.

The leader of a sovereign nation has no authority over another—they are equals. Elected American officials have no authority outside of this country or over international issues. The Declaration of Independence speaks to "the safety of the people," not the buzzwords not found in the Constitution, "national security." Government activities are now violating, not only Constitutional Law, but the "safety of the people." Totalitar-

ian states are military powers which work with force and controlled breeding.

The membership of every civic, community, service, religious and institutional group should be called where there are "real patriots" versus the "pretend patriots" outlined in the *Farewell Address* (the nation's guide to principled foreign policy and blueprint for the republic). That small percentage of regular, registered voters must alert their representatives at all levels of government, that the Constitution must be enforced and that the people are exercising the limits to power by elected leaders who swore to "preserve, protect, and defend" it. Those giving aid and comfort to Executive Branch encroachments and usurpations of power must be recalled, removed, impeached and then charges brought against those conspiring to the subversion of the republic.

Real Americans and real Christians should have stopped Christmas and had

Congressional representatives call a joint session and immediately declare the NATIONAL SECURITY ACT invalid [legislation in conflict with the fundamental law is invalid—see *Federalist Paper #78*]. A vote of 1/5 of those present can open the books [publish secrets] on the activities and expenditures of the U.S. covert government since 1947. (By the present time there should be a personal spy for every taxpayer paying his salary). The covert structure has tied in with the mafia, drug and weapons merchants and the

criminal element of every nation. It has also tied in with the "intelligence communities" of England, France, Israel, etc. Attorney General Thornburgh, who was elevated to "head of an intragency intelligence panel" in conflict with his post, has been trading secrets with the KGB and biological and chemical warfare techniques which are a Bush specialty. Bush took office on the anniversary of *Kristallnacht*, the evening the NAZIs rounded up the Jews, using their victim's assets to fund the genocide.

There is nothing "democratic" about invading another country and setting up a puppet government of C.I.A. drug laundering bankers. There is nothing republican in the platforms illegally validated by the electoral colleges of the last three elections. "Oh ye hypocrites, [Christ saved his strongest rebuke for hypocrisy] ye can discern the face of the sky; but can ye not discern the signs of the times?" Matthew 16:3. The covert substructure has taken over the U.S. Government. The Truth is being silenced by those bought using the U.S. Treasury illegally, using electronic surveillance techniques, using psychological warfare techniques, using infiltration, using Hoover's F.B.I. black-mail files and using the apathy of a drugged people. Benjamin Franklin said,

"You have a republic if you can keep it." This is the anniversary of the Bills of Rights. "The enumeration in the Constitution of certain rights shall not be construed to deny or disparage others retained by the people."

(c) 1989, 1990 N.A.R.G. Chronology

**CHRONOLOGY OF HUMAN AND ALIEN
INTERACTION AND COVERT INTELLIGENCE
OPERATIONS**

Updated: 1 April 1990

(c) 1989, 1990 N.A.R.

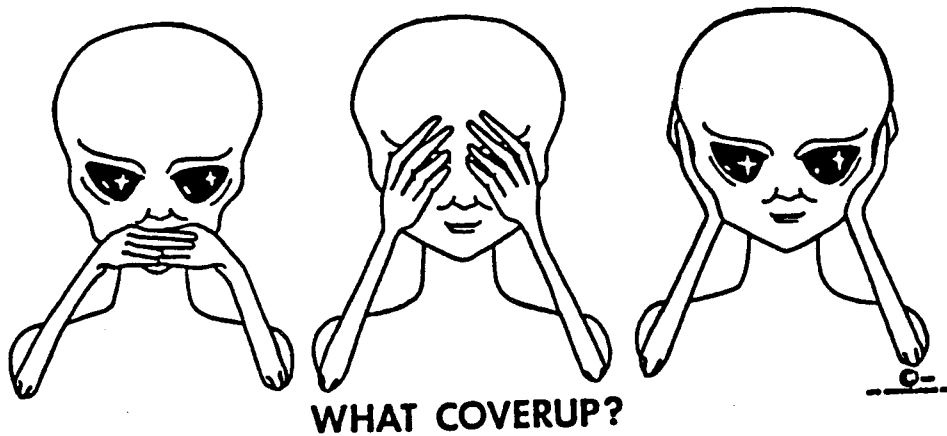

Chronology of Human and Alien Interaction
and Covert Intelligence Operations
Updated: April 1990

Let's examine the covert chronology of human and alien interaction as we understand it at this moment. The chronology is Update 8, April 1990, and it will be updated in future works. The chronology is inter-mixed with other areas such as planetary power structures, so that those interrelationships will also become apparent.

1772

Freemasonry splits into two groups in France, one of which was the Grand Orient Lodge.

1776

Adam Weishaupt, a Jesuit priest, founds the Illuminati.

1777

Weishaupt initiated into the Masonic Order in Munich, Germany

1868

Explorers discover a hidden subterranean tunnel system which extends 900 miles from Cuzco to Lima.

1878

On January 25th, farmer John Martin of Dallas, Texas relates his sighting of a disk in the Dennison Daily news.

1883

On August 12th, José Bonfilla takes several pictures of over 300 objects which cross the sun.

1895

Dr. Fridtjof Nansen conducts an expedition to the North Pole area that started in February, 1895. From March 29, 1895 until the spring of 1896, Nansen is lost in areas that had warm winds coming from the North.

1896

In 1896 and on into 1897 a wave of sightings occurred in the United States. Winged cigar shaped craft and airships.

1898

The worldwide construction firm of Bechtel is founded.

(c) 1989, 1990 N.A.R.G. Chronology Page 2

1908

On June 30th, there is a huge explosion in Tunguska, Siberia.

1909

The first recorded wave of European sightings occurs in England.

T. Henry Moray does his first experiments drawing electrical energy from the Earth.

1917

The Fatima incident occurs in Portugal with hundreds of witnesses.

1919

Adolph Hitler joins the Thule Society in Germany. In the Thule Society, the sun played a prominent role as a sacred symbol of the Aryans. The inner core within the Thule Society were all Satanists.

1915

In December of 1915, a black wall appeared in the Aristarchus crater on the moon, connecting the craters Messier and W.H. Pickering.

1920

In 1920, Unidentified disks were observed during a search for a schooner in the Bass Straits near Australia.

1922

In 1922, three artificial looking mounds appear on the floor of the crater Archimedes. Later three more objects were discovered not far away, composed in the form of a triangle.

1924

In 1924, the chemical giant IG Farben gets its start when an American banker Charles Dawes arranges for \$800 million in loans to consolidate German chemical companies.

1925

T. Henry Moray contacts General Electric about his discoveries.

1926

In 1926, the Knights of Malta support the ascent of Italian fascist leader Mussolini.

1928

In 1928, Thomas Brown discovered a relationship between electrical capacitance and gravitational control. His work was subsequently taken over by the government. American Henry Ford merges his assets with IG Farben.

1929

In 1929, Admiral Byrd conducts expeditions to both poles. A news-reel shown in American theaters described both journeys and showed photographs of mountains, trees, rivers, and an animal described as a prehistoric mammoth.

1930

In 1930, Dr. Henry Goanda began work on aerial craft that were lenticular in shape.

1932

In 1932, Adolph Hitler was in control of the German society enough to force scientists to work in laboratories on advanced aircraft design. Aided by the implosion vortex technology of Viktor Schauburger, and the technical expertise of scientists like Schriever, Habermohl, Ballenzo and Miethe, the Germans make extraordinary progress. There is evidence that they might have been aided by contact with Grey entities from inside the Earth.

In 1932, the United States conducts Naval exercises at Pearl Harbor that demonstrate the vulnerability of the facility.

1933

In 1933, Franklin D. Roosevelt becomes President of the United States. Roosevelt, a Mason like many other Presidents, was the point at which the interaction with the Grey entities began with the US Government. The Masons and other occult groups have maintained an interaction with the Grey entities, especially those whose origin is within the Earth, for thousands of years. The real "New Deal".

Also in 1933, a profusion of German tourists swarm over the southwestern United States, buying land, checking mineral rights and caves and caverns. This was discovered during a background check of some of the cities (and newspapers) in New Mexico. Meetings occurred between President Roosevelt and others in Cartagena, Columbia - the same place where President Bush would meet over the "drug war" in 1989.

Both Columbia and Panama are the site of huge underground caverns.

In the winter of 1933-34, there were 487 sighting cases in Scandinavia (240 Norway, 96 Sweden, 157 Finland).

1934

The first "deal" or interaction with the Grey entities occurred on July 11, 1934 on board a naval ship in Balboa. It was here that the agreement was initially made that let the greys proceed unhindered with the abductions and cattle mutilations. It was during this time period that the United States Navy first begins to get a taste of advanced technology.

1936

During the winter of 1936-37, there was another wave of increased sightings of disks over Scandinavia.

Attempts are made on the life of radiant energy researcher T. Henry Moray.

1937

The Finnish General Staff publish their report on the sighting activities of 1933-34.

1938

In 1938, the Germans begin flying experimental craft using unconventional power sources and methods. Evidence exists with regard to German recovery of downed alien craft.

On April 7, 1938, three men (one in England, one on a ship off the coast of Ireland and one in Nijmegen, Holland) are burned in human spontaneous combustion at the same moment.

In 1938, the government engages Orson Welles to do the "War of the Worlds" broadcast in order to gauge public reaction to the idea of alien contact.

1939

Brookhaven Research Labs in New Jersey perfects single-element teleportation and multi-element teleportation in 1939.

Operation Canned Meat began in 1939, where the Germans stage an incident at the Polish border as a prelude to the invasion.

As a result of all this technology, the German scientific effort was pushed forward by leaps and bounds, and was conducted at several underground research facilities at Reinickendorf, Kammersdorf and

Thuringia. The earliest "pilotless aircraft" were produced in 1934, and has some moderate degree of success. The United States was quite aware of the German technical progress and sent an American named Wilson to Germany to "give technical assistance" and generally to keep an eye on German technology. It was probably by virtue of Wilson that the Germans never used their gravitational craft en masse in the war, for Wilson attained a high position in the German technical community, and switched propulsion methods from gravitational to advanced jet propulsion in an apparent effort to "get technology out there to fight the war". Because of this, German gravitational research remained in the labs and stayed in the R&D phase until around 1941, when the Schriever/Miethe designs were successfully tested.

It was clearly a situation where the war was going on faster than the Germans could technically develop their designs. Hampered by sabotage and deliberate technical misguidance from Wilson, as well as delays in metallurgical research which didn't result in an acceptable alloy of magnesium and aluminum until 1944, the Germans could only continue to harass allied pilots with the "fireballs", pilotless craft developed and used since 1942 which emitted electrical fields that interfered with the operation of aviation engines.

1943

In 1943, the United States Government forcibly moves 110,000 Japanese Americans (other than Yoko Ono's father, a banker) into concentration camps. The consolidation of military power in the US occurs. Heroin addition is almost unheard of in the United States.

British intelligence forces in Canada train US OSS officers.

General Reinhard Gehlen infiltrates Soviet intelligence. Gehlen forms a partnership with Allen Dulles, which results in the creation of the CIA from Nazi SS intelligence officers brought to the US under the auspices of Operations Sunrise, Overcast, and Paperclip.

1944

In February of 1944, an RAF bomber over the Bass Straits noticed a dark disk-like shadow appear alongside the aircraft. It stayed with the aircraft 20 minutes. Electromagnetic effects were apparent on instrumentation.

1945

In 1945, the British discovered German plans for advanced craft and joined the efforts of the United States to subvert the German program. On February 16, 1945, despite allied efforts, the Germans successfully flew a crew-carrying version of the "fireball" from the underground facilities in Thuringia. The craft had a top speed of over 1,250 mph. The craft was called the "Kugelblitz".

The Germans in the scientific community knew the war was lost as early as 1942. They decided to establish a plan for continuing the dream of the Third Reich despite the war. They decided that the establishment of a separate society founded on Nazi principles of genetic purity was the answer. The development of gravitational technology aided that plan. On February 23, 1945, the newest engines of the Kugelbitz were tested and then extracted from the craft. The Kugelbitz was blown up by SS personnel and the scientists, plans and engines were shipped out of Germany to the South Polar regions, where the Germans had maintained underground construction activity since 1941. Two days later, on February 25, 1943, the underground plant at Khala was closed and all the workers sent to Buchenwald and gassed.

The Germans also send their "aryan elite" children and other elements of their society to the underground base. General Hans Kammler, who disappeared in April 1945, was instrumental in the evacuation operation, as was a General Nebe. There, the Germans developed a eugenic society that apparently is limited to a specific number of people. They're still there. Apparently they also maintain technical colonies in South America.

On April 12, 1945, Roosevelt dies and Harry Truman, a Mason, becomes President of the United States.

On May 7, 1945, Germany surrendered. Both the Americans and Soviets gained access to elements of German disk technology and scientists which the Germans had neglected to eliminate before the hasty departure at the close of the war. The Canadians also had access to some of the data that the United States had acquired, as well as some data directly from the German efforts.

On July 16, 1945, the United States detonated their first nuclear explosion in New Mexico. By August 15, 1945, the Japanese had "been induced to surrender", despite the fact that the Japanese government had offered to surrender on February 14, 1945 and again in June 1945. Both offers were refused by the United States, who preferred to use the nuclear device on them two months later, as planned. It is most probable that the nuclear detonations also attracted the attention of non-human entities.

On September 20th, Von Braun and other V-2 colleagues arrive in Boston, Mass and are transported to White Sands New Mexico to work in the US missile program. Over 1,000 scientists are transported to the United States and given false papers in order to work for the US Government.

1946

In 1946, the United States imported German SS intelligence officers in an effort to form what later became the Central Intelligence Agency. This was part of a plan conducted by Allen Dulles in 1943, when a deal was cut with German intelligence to provide the United States with a viable intelligence operation as well as provide German intelligence with a place to go after the war. A good inducement, indeed.

The Swedish government convenes a panel that examined over 1,000 UFO reports. There is a "ghost rocket" flap over Sweden. Over 225 reports referred to real physical objects seen in broad daylight.

1947

In 1947, the National Security Council was founded. Admiral Byrd takes a photo of an oasis at one of the poles.

In 1947, the powerful radar unit in the four corners area in the Midwest caused the crash of several alien disks, the most notable of which were at Roswell and Aztec, New Mexico. The disks recovered had a reptilian species on board, as well as the bodies of United States Air Force pilots. There was evidence that the bodies had been mutilated. In June 1947, Kenneth Arnold coins the term flying saucer.

The Germans, having had two years to get it together after the war, started making flyovers over the United States in their disks, which had by then achieved a remarkable degree of development. This prompted the United States to undertake plans to ascertain both the exact location of the German base at the Pole and their technical capabilities. In 1947, Operation Highjump was conducted at the pole in an attempt to locate the Germans. It was a failure. The Germans used their technology to thwart the efforts of the United States. It wasn't until 1958 during the International Geophysical Year that another major attempt to work on the Germans was made. Various polar expeditions that occurred in between 1947 and 1958 had intelligence as part of their design, and also seemed to evoke activity from other forces and entities from inside the Earth. There also seems to be some evidence that the Germans made contact with alien forces from inside the planet during the stint at the pole.

In 1947, the United States decided that the problem with both the Germans and the aliens was getting a little dangerous, and it was necessary to implement severe measures in order to hide the truth of alien presence. The German problem was easier to control as far as public knowledge was concerned. In September 1947, Truman caused the National Security Act to be passed in order to hide the activities of the Government, the CIA and the alien problem. CIA mind control projects began at Bethesda Naval Hospital in 1947, with data gained from German SS intelligence. Truman created a study group in order to control the alien problem. A series of National Security Council (NSC) memos removed the CIA from the sole task of gathering foreign intelligence and slowly legalized direct action in the form of covert activities. The memos, including NSC-10/1 and NSC-10/2, established a buffer between the President of the United States and the activities that were going on, as well as providing a means for the President to deny knowledge of any covert activities.

It was decided that more knowledge was needed about the various types of alien craft. Project Sign, created on December 30, 1947 and established at Wright Field, was to investigate disk technical capabilities and performance. There was still the problem of evaluation of the disks that had been recovered. It was decided that the Navy Auxiliary Field in the Groom Mountains in Nevada would be the ideal spot to do the testing. 403

In 1947, fifty percent of the CIA is composed of Nazi SS intelligence personnel.

In 1947, the company EG & G is founded by three MIT graduates Harold Edgerton, Kenneth Germeshausen and Herbert Grier. The company would become later famous as the employer of Robert Lazar, scientist who revealed government possession of alien disks in 1989.

In 1947, the Maury Island incident occurs, where an explosion occurs on a disk and physical evidence is left. The government and the Men-in-Black become involved, and the evidence is destroyed along with the lives of USAF pilots.

1948

In August 1948, Project Sign prepared a Top Secret estimate of the situation, which was designated as Air Intelligence Report 100-203-79.

General Hoyt Vandenburg, after reviewing the report, ordered the report destroyed. Not all copies of the report were destroyed in December 1948; at least one still survives. Project Sign was redesignated in December 1948 as Project Grudge, with public version to be known as Project Bluebook. The liaison between Project Grudge and MJ-12 was the Air Force officer in charge of Project Bluebook, Captain Edward Ruppelt.

Early implanted transmitters used radio waves and were embedded in the teeth or jawbone. The United States prepares to use chemical and biological weapons in Korea.

In 1948, the value of television as a mass control medium is fully realized. Right-wing soviet intelligence personnel move into US society. Mass lobotomies introduced as control method.

1949

1949 was also the year that construction started on AEC property on Nellis range of the complex designated to perform testing and evaluation of alien technology. It was also another year that German disks started flyovers in the United States. As a response to this activity and the general alien problem, the CIA Act of 1949 was enacted, giving the agency more capability to act outside the bounds of established law in order to guarantee that the alien problem remained inside the government. At that point, the CIA office of Scientific Intelligence began to review civilian reports of sightings in order to determine the scope of the suppression effort.

It was in 1949 that the Soviet Union detonated their first above ground nuclear test. It is uncertain whether the Soviet effort to produce a nuclear device was aided by the delivery to them of 1 kilogram of uranium in 1943 by the United States, or the subsequent delivery of nuclear weapons plans to the Soviets in the same year by President Roosevelt under the Lend Lease program. A major who was in charge of the transfer of Lend Lease supplies discovered that at least three consignments of uranium chemicals totaling .75 ton, as well as documents and reports, were transferred to the Soviets.

In 1949, George Orwell's book "1948" was renamed "1984" by the publisher. International heroin supply routes are reinforced. Lucky Luciano moves to Italy to start up heroin processing labs.

Julius and Ethel Rosenberg were blamed for the Soviet weapons acquisition during the next year, and were summarily executed in order to cover up the technology exchange. President Roosevelt's son, James, wrote a book entitled "A Family Matter" in which he details Roosevelt's "bold decision" to share the nuclear technology with the Soviet Union.

In 1949, alien craft were often seen hovering over sensitive nuclear installations, especially in New Mexico, and probes known as "green fireballs" were frequently seen all over the state; they were presumably monitoring something to do with radiation. The disk crash at Roswell, New Mexico netted one live alien, named EBE (Extra-terrestrial Biological Entity). It was a name coined by study group member Detlev Bronk.

Secretary of Defense James Forrestal became disenchanted with the whole handling of the alien problem. He voiced his concern to President Truman, who asked him to resign on March 3, 1949. Within one month, the White House had all 3,000 pages of the diaries of James Forrestal locked up in a white house safe and had sent him to Bethesda Naval Hospital under the care of Dr Raines. Forrestal's brother decided to take him out of the hospital, fearing for his brothers' life. On same day his brother was due to pick him up, James Forrestal was found hanging outside of a 16th story window of the hospital with a sheet around his neck. The sheet broke, and Forrestal fell to his death.

By December 1949, the government decided to close Project Grudge and divert efforts elsewhere. The Central Intelligence Agency begins its mind control research in earnest.

1950

In 1950, Canadian scientist Wilber Smith reported in a letter that the disks were one of the most highly classified issues in the United States Government, even "higher than the H-bomb", which President Truman ordered into production in January of 1950. In 1950, problems continued with alien disks. There were near misses with commercial airline flights, and continued overflights over sensitive military installations. By August of 1950, it was decided to let General Walter B. Smith assume Forrestal's vacant position in the study group. It was also the same month that the Government decided to seize all US railroads in order to prevent a general strike.

In December of 1950, a unit called IPU , Interplanetary Phenomenon Unit, was established operational unit to deal with the ever-increasing scenarios of crashed disks and aliens. That same month a disk crashed in the El Indio-Guerro area of Mexico and was taken to the AEC facility at Sandia in New Mexico.

In 1950, the revised edition of "The Effects of Atomic Weapons" prepared by the AEC advises "complete underground placement of bases is desirable" and "there are apparently no fundamental difficulties in construction and operating underground in various types of important facilities".(page 381)

1951

In 1951, construction of the base at Groom Lake took on a more earnest effort with Project Redlight. Information leaked out that disks were stored at Wright Patterson AFB in Dayton, Ohio. Viking Press published a version of the Forrestal diaries.

Flying wing type aircraft were seen over Albuquerque. The alien named EBE suddenly became ill, and was worked on by a Dr. Mendoza for almost a year until 1952, when the alien died.

General MacArthur, famous for his statement about interplanetary war being inevitable, was relieved of his command by President Truman.

In 1951, the CIA was essentially telling the public that it was closing its books on the "UFO" problem. President Truman created the National Security Agency (NSA) in 1952 to monitor and contain the secret of alien presence, decipher alien communications and eventually establish an ongoing dialogue with any alien species it could make communications with. Presidential Executive Order exempts the NSA from all laws except those laws which specifically mention the NSA.

In 1951, Allen Dulles orders 100 million doses of LSD from Sandoz Laboratories for CIA use.

1952

President Truman kept the allies of the United States, including the Soviet Union, informed of the developing alien problem ever since the recovery of the crashed disk in Roswell, just in case it was discovered that the aliens turned out to be a threat. The problem was that there was an ever increasing threat to security about the aliens. To solve that problem, the group known as the Bilderbergers was created in order to take the decision making about the alien problem and other international issues out of the hands of governments. The Bilderbergers are headquartered in Geneva, and evolved into the elite secret body that still controls international situations. Nelson Rockefeller, Gerald Ford, Henry Kissinger and George Bush are involved with the world control groups, and have been for many years.

Also in 1952, agencies of the Canadian government co-operate with the United States Air Force in "experiments" in biological warfare involving the aerial spraying of contaminants over the entire city of Winnipeg.

In July 1952, disks overflew Washington, D.C., creating a public stir. One of the disks flew away at a speed estimated at over 7,300 mph.

The Defense Industrial Security Command (DISCO) is started. It is and remains today one of the worlds largest security forces. Reinhard Gehlen and Allen Dulles are dubbed Knights of Malta by the Vatican.

1953

In 1953, Thomas Brown gave a demonstration of his electrogravitic effect to the Air Force, who promptly took over the project. It was also the year that Eisenhower was elected. It was Eisenhower who appointed Rockefeller to head a group that would propose a reorganization of government. Eisenhower's favorite comment seemed to be "do whatever it takes". That comment seemed to form the basis for all actions to do with the alien problem from then on.

Project Sigma, created in 1953 and run by the NSA, functioned to intercept and decrypt alien communications. With ten disk crashes, 26 dead and 4 live aliens, and a lot of security problems in 1953, the effort to maintain security took a supreme effort.

Albert K. Benders International Flying Saucer Bureau was closed down following work on a theory linking disks with Antarctica. Bender is visited by MIB and persuaded to stop his research.

Eisenhower, in 1953, asked Rockefeller for help with the alien problem. This is where the idea for MJ-12 was born. It was probably a critical mistake in asking a member of the world control group for help with a problem with alien beings.

Astronomers in 1953 made a rather disturbing discovery of a large object that entered the solar system, which later proved to be an object that was intelligently guided and emitted communication signals. The Air Force, in the same year, discovered huge orbiting objects between 100 to 500 miles altitude. They were alien craft.

Project Plato, governed by the NSA, endeavored to establish some sort of diplomatic relations with the alien species that had appeared. In 1953, the NSA was successful at this task, and the CIA, perceiving that more public disinformation was needed, convened the Robertson Panel. The summation report, issued in January of 1953, stated that there was "no threat to national security from UFOS". By now, some of the aliens were known, and therefore the semantics describing "unidentified" flying objects could be truth fully used. Contact was made in 1953 with an alien species and Project Plato culminated in a meeting was arranged with the aliens at Holloman AFB in New Mexico for 1954. Previous agreements were reinforced where the aliens would not interfere in our affairs and we would not interfere with their affairs. We would let them do what they want and also establish underground bases here in exchange for alien technology. See July 11, 1934.

Concern for public probing into the "UFO" question caused the government to come up with the idea of developing disks using conventional technology and then displaying them to the public. This would take the heat off the real programs. Project Snowbird was created for this purpose. It too, was headquartered in Nevada.

The United States and the Canadians had been cooperating for some time on the disk technology, and in 1954 successful tests were made of some jointly developed disk designs. Project Redlight sustains its first death of an Air Force pilot in Nevada during a test of an alien vehicle.

Project Pounce was created to provide a general process of disk and occupant recovery, as well as providing cover stories. It too was run by the NSA. Project Plato, another NSA project, was initiated in order to establish a continuing program of technological evaluation of alien disks.

Increasing numbers of people in the public domain began to have encounters with alien beings. In order to retain the element of secrecy, the Air Force established a number of "debriefing colonies" in the United States for contactees and their families - a practice which continued well into the 1960's and beyond.

The Government also had contact with another race of aliens in 1953. This race would not share technology with the government, and despite their warnings about the Greys the government broke off contact with them, preferring to allow the Greys to trade technology in mind control, beam weaponry and gravitation for silence on the part of the United States about their abduction and mutilation operations.

Eisenhower orders three journalists jailed for attempting to publish information about US use of chemical and biological weapons in Korea.

1954

In 1954, Dr. Wilhelm Reich began experiments with his cloud-buster equipment, and discovered that he could affect the propulsion systems of some of the alien disks. Reich's discoveries also involved the manipulation of biological energy in terms of conquering disease. It didn't take the government long to realize what a threat Reich was to the established order, and Reich was hassled by the government and jailed. He was finally murdered in Lewisburg prison in November 1957.

In 1954, a wave of UFO sightings occurs in France.

In July 1954, a woman in Poland gets abducted by hump-backed aliens and experiences missing time. Entities with humps were also reported in 1978 and 1979.

1955

In 1955, a large doughnut shaped UFO is seen over New York. The US Navy announces Byrd's expedition to the South Pole.

In 1955, a documentary film about UFOs was released from Hollywood in an attempt to demystify UFOs as far as the public was concerned. The CIA mind control program, which was authorized in 1953 when Allan Dulles approved project MKDELTA, took on a new insidious turn when mind control drugs began to be given to subjects in normal settings in order to observe the effects. Later, by 1956, testing of mind control drugs on prisoners would be approved.

The National Security Council had established a "deal" with the Greys. The Greys would make sure that they would give a periodic list of abductees to the NSC. By April of 1954, it became obvious to the Eisenhower administration that the Greys had broken the agreement and were abducting far more people than they reported, including large numbers of children.

Also in 1955, Henry Kissinger was chosen as the head of the alien study group, known as the JASON society, under National Security Council provision NSC 5411. NSC edict 5412/2 established the original study committee. In 1956 the group, publicly referred to as the Quantico group, was closed. The 5412 designation became public knowledge, but the purpose of the group remained secret.

1956

On January 13th, Byrd and the US Navy fly to a point 2,300 miles beyond the pole and admit it was over land.

In 1956, Captain Ruppelt, who left the Air Force in 1953, wrote and published his famous book "Report on Unidentified Flying Objects"; he also made a statement that year about a "group of Germans having advanced aerial vehicles".

Mind Control experiments on prison inmates approved in the United States. On August 13th, radar operators at RAF Bentwaters England (later to have a CEIV in 1980-1) detect objects flying over the North Sea at a speed of 4,000 mph.

1957

By 1957, Joseph McCarthy was becoming a problem. He was admitted to Bethesda Naval Hospital where, of course, he mysteriously died.

In 1957, it was decided that the course of human evolution would make the planet uninhabitable by the year 2000, so various "Alternatives" were discussed. Alternative 1 was to allow things to continue the way they were and hope things could be repaired. The second alternative was to arrange for underground cities and

facilities to be built in order to insure the survival of select groups of people. Alternative 3 was migration to other planets. Both Alternatives 2 and 3 were chosen as being the most viable. Work was then started on both of them. In order to implement Alternative 3, alien technology would be needed. It was also necessary to push for more complete forms of mind control in order to insure a smooth flow of operations despite any opposition that might occur.

In 1957, work under Project Redlight was begun in earnest in Nevada. A facility code named DREAMLAND was constructed in the proximity of an alien underground base known as "S-4". Here, the process of exchange of alien technology began.

In 1957, Antonio Villas Boas gets abducted in Minas Gerais, Brazil, and was seduced by a red-haired humanoid, supporting views that earth's genetic pool is being used by other races.

In 1957, the AEC begins Project Plowshare and Project Gasbuggy, where nuclear explosives are used underground to stimulate natural (radioactive) gas production. For some reason, early tests are held near Dulce, New Mexico.

1958

On January 10th, University of California Livermore Radiation lab scientist Nicholas Christophilos derives the idea for Project Argus, where nuclear devices are detonated in space to surround the Earth with deadly radiation belts, which will disrupt satellites. The project is promoted by Dr. Edward Teller.

In 1958, International Geophysical Year, expeditions were made to the poles in order to again assess the problem of the Germans, as well as the threat from aliens of different character that were detected as coming from inside the Earth. Work continued on Alternatives 2 and 3. Use of the "Orion" method of hypnosis, used on government workers in high security areas, begins.

Also in 1958, doctors at McGill University in Montreal use their patients as unknowing "human guinea pigs" in CIA-funded experiments with LSD.

The National Aeronautics and Space Administration is created by the National Aeronautics and Space Act of 1958.

Project Argus detonates nuclear weapons in space on August 27th, 28th and September 6th.

1959

In 1959, the RAND Corporation held several conferences on Deep Underground Construction. These conferences were attended by the various military services as well as large corporate construction firms like Bechtel. Underground construction projects began within a year. Existing underground facilities were beefed up and new ones were started. Funding for government underground facilities comes from "Presidential Shelter" funds, as well as covert drug operations conducted by the CIA under the orders of MJ-12. This procedure appears to be still in effect as of July 1989. Over 75 underground facilities have been constructed under various programs.

Also in 1959, Joseph Bryan, CIA Psychological Warfare director, met with Major Donald Keyhoe in order to review cases. Keyhoe refuses. Captain Ruppelt, dissatisfied with governmental operations in terms of "UFO investigations" is becoming an increasing problem.

1960

In 1960, Edward Ruppelt mysteriously dies of a heart attack. In that year, Project Aquarius is initiated in order to collect medical and technical information from alien technology. It was another NSA sponsored project. Ronald Reagan is governor of California. His personal secretary was a former translator for those Germans over Eichmann during World War II.

1961

In 1961, Cape Canaveral/Kennedy radar locked onto an object that was following a Polaris missile over the ocean. Vice-president Johnson's private aircraft crashes. Radar showed UFOs in the area.

In 1961, John Kennedy was elected president. He orders NORAD not to divulge information about foreign space vehicles. Experiments with ultrasonics and brain lesions are done by universities. Donald Keyhoe begins sending proof of his censorship to Congress. At Fort Ord, 221 military members are abducted and implanted with devices. They and their families are sequestered.

By May 1961, a House subcommittee had been formed to look into the subject of UFOs. It was again put down and the problem seemed to 'disappear' for a while. Kennedy, dissatisfied with some areas in the covert governmental structure, threatens to go public. In 1962 the Bilderburgers meet to discuss the problem.

On September 21st, two Boeing 707's encountered a large UFO over the Pacific. The craft in this well documented case, was a doughnut shaped object.

In 1961, the abduction of Betty and Barney Hill occurred in New Hampshire. At Ford Ord Army base, 221 soldiers are abducted en masse, implanted and released. All are sedated through the efforts of 600 other soldiers recruited for the purpose and debriefed. Many suffer severe physical and psychological trauma.

Mind control programs under the CIA and NSA perfect methods for duplication of personalities. The CIA begins the plotting process to involve the US in Vietnam, where there are natural resources like rubber, metals and heroin. Mass psychosurgery is introduced in mental hospitals.

1962

On September 9th, the United States detonates another Project Argus nuclear explosion in space named "Starfish", detonated more than 200 KM over Johnston Island in the Pacific.

In October and November 1962, the Soviet Union detonates three nuclear devices in space over Siberia.

1962 was the year that the American public watched John Glenn orbit the Earth in the manned "space program", which was a public program designed to be a pool where funds could be siphoned off for work on covert projects. Some of the projects were concerned with the development of alien technology.

1962 was also the year that a space probe was landed on Mars. It confirmed the presence of a viable atmosphere and further strengthened the push for Alternative 3. Disk activity is observed by the public around the area of Dulce, New Mexico, the area that would later become famous as the site of a joint government alien facility.

The Central Intelligence Agency forms a front corporation known as Permadox, in Canada, to handle worldwide opium traffic.

1963

In 1963, Kennedy evidently issued an ultimatum to MJ-12, and they decided that Kennedy should be subject to an expediency - killed. This was the era when the United States first started having its own operational disks. 1963 is the date of one of the earliest visits to an underground joint base by an abductee that came back and lived to tell about it. It is the first hint of the underground breeding facilities that are described in the Dulce Papers, events surrounding Paul Bennewitz and Thunder Scientific Corporation in Albuquerque, New Mexico, and other insidious experiences that have been reported by scores of people from 1963 to 1989.

Within a month after Kennedy's murder, the Bilderbergers met again to formulate their plans. In England, mind control experiments began in Warminster. Lonnie Zamora's abduction case gave further impetus to public awareness of abduction by alien entities.

In May 1963, Gordon Cooper on the Mercury flight has visual contact with a UFO while in orbit.

In 1963, Ambrose (maker of Zyklon-B gas) is brought to the United States by J.Peter Grace.

1964

In April 1964, Cape Kennedy radar technicians track disks in pursuit of the Gemini capsule. On April 15, two intelligence personnel meet under Project Plato with aliens in the New Mexico desert to arrange a meeting on April 25 at Holloman AFB, New Mexico in order to "renew" the treaty in a psychological bid to buy time in order to solve the problem of the Greys.

In May 1964, the book "The Invisible Government" was released, and many significant details about the operation of the CIA were released to the public.

In the summer of 1964, alleged metal samples from the Socorro case were being analyzed. Scientist Ray Stanford states that the samples are an unknown alloy. On August 20, 1964, fifteen days after Stanford makes his statement, NASA scientist Sciacca states that the Socorro sample is silicon.

September 17, 1964 marked the release of the Warren Commission Report on the Kennedy assassination, intended to pacify the public about the event and obscure the details about the assassination. In December, disks were back again, buzzing the Pautuxent Naval Air Station in Maryland.

1965

In 1965, the Bilderbergers met again. George Adamski takes motion pictures of an object at Silver Spring, Maryland on February 26, 1965. On March 18, the Soviets give a less-than-adequate performance during the "spacewalk" of Leonid. It's obviously a staged event not taking place in space. In June, astronaut James McDivitt sees an object in space and reports it. The government begins to review data about the earth energy grid system detailed by Dr Bruce Cathie in New Zealand. It is believed that the energy grid provides power to sustain some of the implant systems and other equipment that the aliens use. It also provides (if the tilt of the earth is correct) the power to energize apparent "window areas" on the planet and open dimensional doorways.

On April 23, 1965, George Adamski dies in Silver Spring, Maryland.

In the autumn of 1965, the Canadian Institute for Defence Analysis duplicate Soviet experiments showing microwave effects on central nervous system of test animals. In the United States, the Advanced Research Projects Agency sets up a project where Rhesus monkeys are irradiated with microwaves to test Soviet emission results.

1966

By 1966, actual technology on-board far exceeded technology that was made available to the public. It is believed that a research lab in Silicon Valley had developed 3 dimensional television and had it perfected. Video tape was also in the process of being developed for release. The SR-71 blackbird, an aircraft having advanced design and special alloy skins allowing it to travel to the fringes of space, was designed and built. It was around that time period that people became acutely aware of the series of underground tunnel systems that lie under California and the other western states that connect corporations and other facilities together.

1966 marked the end of the mind control experiments in Warmimster, England. Cheyenne Mountain and its NORAD facility is activated, and the Bilderbergers meet again. Henry Kissinger, Olaf Palme (who would authorize the use of implants in Sweden in 1971 and subsequently be murdered), Gerald Ford and Schmidt from Germany were among the attendees. The NASA budget had swelled to over \$572 million dollars.

A 1966 Gallup poll indicated that over 8 million people had seen UFOs in the United States. Public interest increased. It was time to manipulate public opinion again. The Condon Committee was set up, chaired by Edward Condon, who admitted his forgone conclusion that UFOs didn't exist. The Condon Committee announced its results to the public, declaring the UFOs didn't really have any basis in reality. It was the beginning of a debunking process that would culminate in 1969 when the Air Force made a public announcement that they are "closing Project Bluebook". Congressman Gerald Ford makes a declaration to Congress that they should look into the subject of UFOs. Two months later, in June 1966, disks interrupt tests at Pine Gap facility near Alice Springs, Australia.

In 1966, the Soviet Union has a massive wave of sightings.

In August 1966, Dr J. Allen Hynek publicly criticizes scientists for not investigating UFO reports.

1967

In 1967, Astronomer James E. MacDonald sees a classified version of the 1953 Robertson Report and becomes a critic of the Air Force and the CIA. MacDonald makes a statement that UFOs may be visitors spying on the planet. Also in 1967, a large shipment of gold leaves Fort Knox, destination unknown.

In October 1967, Britain is hit by a wave of disk sightings. In December, the Schirmer case in Nebraska becomes the most interesting abduction base of the year. Schirmer is brought to an underground base and relates the details afterward.

(c) 1989, 1990 N.A.R.G. Chronology Page 19

The Swedish begin covert implantation of 20mm brain transmitter devices on prisoners.

Weird creatures described as Mothmen are seen in West Virginia.

1968

In 1968, the Bilderbergers meet again. Disks with spheres on the bottom known to be flown by the US Navy frequent areas around China Lake in California. A case becomes evident where a horse in Nevada was hit by a beam from a disk, in front of a witness, and had its spinal fluid and blood drained from its body.

In May 1968, disks frequented the demilitarized zone in Vietnam, giving rise to a series of events which seemed to culminate later in 1972, when a B-52 bomber was thrown to the ground by a UFO and the crew disemboweled in classical mutilation style - right in their crew seats. Pictures were taken and the plane was burned as it stood.

From December 21st to 28th, the Apollo 8 mission returns with a remarkable selection of color photos from the far side of the moon.

1969

In 1969, Richard Nixon becomes president. Edward Condon releases his book "Scientific Study of UFOS" in an attempt to further obscure the subject as far as the public is concerned. The US Army Language School R&D department produces a brain nullifier device. The Air Force declares Project Bluebook abandoned "out of lack of interest". The Brazilian Air Force issues a directive forbidding release of UFO info to the press. Donald Keyhoe, a longtime enemy of the government, is ousted from NICAP and replaced by CIA operative John Acuff.

On May 28, 1969, former president Eisenhower dies, marking the last time a President will have full knowledge of the whole alien situation until the election of President Bush in 1988.

On July 20-21, 1969, the public is treated to Neil Armstrong landing on the Moon (in the wrong place). Armstrong and his crew are treated to views of huge alien spacecraft surrounding their landing site. Radio hams pick up the chatter involved in the incident.

A controversy erupted in 1969 over the 1950 Internal Security Act which authorized detention camps in the United States. Senator Daniel Inouye introduced a bill to abolish the section of the Act which dealt with detention camps and it was quickly passed into law. Despite the government's official policy, some believe the law has been violated.

Years later, a suit was filed in US District court in Houston by businessman William Pabst, who charged that the federal government

established secret concentration camps and mental hospitals for the purpose of jailing political dissidents. Pabst said that a massive computer system exists whereby government officials have access to the names of citizens in order to arrest and control them.

By 1969, the NASA budget has shrunk to a mere \$44 million. They don't want any more intrusions into the operation on the moon. In October of 1969, Jimmy Carter sees and reports a UFO.

In 1969, the American Association for the Advancement of Science holds a Symposium on UFO's in Boston. Dr James McDonald faults the scientific community for not studying the data adequately.

In 1969, a major flap of craft sightings occurs in Australia.

1970

In 1970, the Bilderbergers meet. The world population is 3.6 billion. In October 1970, Canadian Prime Minister Trudeau suspends the Canadian Bill of Rights, which allows search without warrant.

The CIA's MK-ULTRA mind control programs establish formal target groups: prisoners, old people, psychiatric inmates, blacks, women, and youth. "Be silent, consume and die". Genocide plans brought from WWII Germany are brought into bear in the attempt to eliminate chosen social groups.

In November of 1970, three large cigar-shaped objects were sighted on the floor of the crater Archimedes. Two were parked in their northern area and one was parked in the southern area.

1971

In 1971 the Bilderbergers meet again, this time in Woodstock Vermont. The Air Force still continues Project Bluebook. A bill is introduced again to repeal Title 2 of the Internal Security Act as far as detention camps are concerned. Currently, emergency provisions still stand on the books.

In June 1971, Dr James E. MacDonald mysteriously drives out into the desert and "shoots himself" in the head.

In September 1971, the first International Conference on Extra-Terrestrial Civilizations was held in Soviet Armenia.

In 1971, Edwin Wilson, worldwide arms dealer, and other arms dealers finance the training and arming of worldwide terrorist groups in order to induce fear, weapons buying, and justification for more police state authoritarian control over societies.

1972

In 1972, the Central Security Service (CSS) was created at Fort Meade. Purpose: Communication interception. Project Redlight assumes a new phase of operations in Nevada. The first Watergate break-in occurs. Scientist Rene Hardy, also a prominent ufologist, is found dead; an apparent suicide. The CIA mind control project at Bethesda Naval Hospital ends. On June 12, 1972, the second and most prominent Watergate breakin occurs. In December, astronaut Edgar Mitchell admits that NASA has provisions for encounters with alien lifeforms. On December 26, 1972, President Truman dies.

The files that were connected with some of the CIA mind control projects are ordered destroyed by Richard Helms and Sid Gottlieb.

From December 7th to 19th, the last Apollo landing mission was complete. Apollo 17 engaged in intensive lunar backside photography. The King crater seemed to be one of their main targets.

In late 1972 and early 1973, numerous sightings of disks occurred in South Africa, Latin America, Eastern Europe, Canada and in Australia.

1973

In 1973, increasing numbers of aerial craft are being seen. A visit to the underground base at Twenty-nine Palms is documented by an Air Force member who takes pictures of an alien autopsy and an alien craft that is bigger on the inside than outside. Brazilian State Directive, Institutional Act No.5, forbids dissemination of UFO related information. NICAP files are taken over by Hynes' Center for UFO Studies. Scientists again discover a large object moving toward the Earth. It is confirmed to be another alien craft.

The Defense Advanced Research Projects Agency (DARPA) sponsors research into mind-reading machines that decipher brain waves. The program to analyze brain waves in real time begins.

In 1973, Swedish Prime Minister Olaf Palme (later murdered) gives police additional rights to insert brain transmitters into human beings - a process that started in 1972.

On October 25, 1973, a disk buzzes the National Security Agency High-frequency transmitter facility at NW Cape in Western Australia.

1974

In 1974, large numbers of animal mutilations begin to occur in Texas. Hynek visits APRO headquarters and is denied access to their files. Nelson Rockefeller becomes vice-president. The Soviets begin their research into weather modification. A photo of a disk is taken by an aviation photographer near Nellis AFB, Nevada. In February 1974, Robert Galley, French Minister for Defense, goes on TV and publicly states that the disks are real.

In 1974, the Common Market computer called "The Beast" is unveiled in Brussels by Dr. Hanrick Eldeman.

1975

In 1975, the Bilderbergers meet again. Stanford Research Institute tests a primitive mind-reading machine for the public to see. UFOs continue to frequency nuclear sites and sensitive installations

In 1975, captured German technology allows development of a sonic weapon against the EBEs under the name of Project Gabriel. The project continues until 1978. In November of 1975, Travis Walton gets abducted and is returned five days later.

In 1975, bases in the northern tier of the United States are overflown by UFO's. Chase planes lose them near New Brunswick, Canada.

1976

In 1976, the NASA budget is back up to around \$121 million for R&D projects. The area around Dulce, New Mexico starts to experience another intense wave of animal mutilations. NICAP begins its downward financial slide. George Bush becomes director for the CIA. Documents are released from the CIA via the Freedom of Information Act that indicate that ultrasonics research lasted 20 years.

In April 1976, NSC directive 4A authorized covert psychological activities to be conducted against American citizens.

May, 1976 was the 200th anniversary of the founding of the Illuminati.

In 1976, the the public views the Viking series of spacecraft land on Mars.

1977

In 1977, the United States sells the Soviet Union a supermagnet which they then use for weather modification. President Carter gets elected and says that he'll make every piece of information about

UFOs available to the public. Carter is shown a disk and changes his mind. In 1977, the intelligence branch of the Royal Air Force decides to no longer publish statistical reports about UFOs. The Freedom of Information Act was passed in 1977. In May 1977, Jack Acuff, CIA representative in NICAP, is approached by Soviet KGB agents in regard to UFOs.

In August 1977, the Department of Energy is established by the Dept of Energy Organizational Act, pursuant to Executive Order 12009, Sept 13, 1977.

In September 1977, a Red Flag pilot strays over Dreamland and is reassigned within 48 hours to another base. Also in September, USAF Colonel Senn sends a letter to NASA General Crow, expressing the hope that UFO investigation will stop.

In 1977, the movie "Close Encounters of the Third Kind" is released. The BBC releases the television program "Alternative 3".

In late 1977, mysterious sonic booms are heard off the eastern seaboard of the United States.

1978

In 1978 a wave of sightings in England begins that lasts until 1983, with some 3,000 sightings documented. In 1978, an NSA employee provides CIA NICAP representative Jack Acuff with classified UFO related documents. The movie "Close Encounters" is released to the public; a new effort at acclimation toward pseudo-friendly aliens. In 1978 the United States sends new F-16 aircraft to NATO allies on Soviet ships. A former CIA employee verifies drawings of alien hands made at autopsies. Leonard Stringfield publishes "Situation Red". The magazine "Harrisburg" predicts an incident at three mile island nuclear plant for March 28, 1979.

On March 18, 1978, William Herman is abducted and told by the aliens of the existence of a "network" of civilizations. They also confirm the loss of ships in the 1940's because of radar units. On June 19, 1978, president Carter issues an executive order creating the Federal Emergency Management Agency; an act viewed by some to be unconstitutional.

In September 1978, scientist Paul Bennewitz discovers the activities of alien craft at Manzano Weapons Storage area outside of Albuquerque, New Mexico. Bennewitz submits a report called Project Beta to the government and is put under observation. He was allegedly subjected to three bouts with electroshock treatment starting in 1979, then was left to be observed by both the government and the aliens with whom he had been communicating through his computer equipment.

Also in 1978, the Federal Emergency Management Agency conducts its first Rex exercise, Rex-78. Sixty-two professional astronomers report seeing UFO's. A vivid, prolonged close encounter occurs at Bakers Creek Falls, near Armidale, Australia. Multiple witnesses and a shoot-out against the disk occurs near Fort George.

On October 25th, Australia pilot Frederick Valentich disappears during a flight over Bass Straits. On November 9th, a disk landing event occurs in Kuwait.

The CIA has secured control over most of the worldwide traffic in opium by the end of 1978. The RAND Corporation does de-population and martial law studies.

In November 1978, a huge cylindrical object was seen hovering over oil company equipment in Kuwait. The object was observed for seven minutes.

1979

In 1979, a conference on animal mutilations was organized by Senators Harrison "Last Man on the Moon" Schmitt and attended by Scientist Henry Montieith, who had just completed ten years of research on the subject. According to Schmitt's figures, economic losses from the mutilations totaled over \$2.5 million annually. Men in Black are also in attendance.

The conclusion of the conference was that there was something of substance in animal mutilation cases that could not be explained.

1979 was the year that an disgruntled scientist at the Dulce Bio-Genetics Facility fled with videos, pictures and notes, vowing to expose the atrocities found there. Sixty-six NRO/Delta are killed that same year.

Presidential candidate Ronald Reagan visits NORAD in Cheyenne Mountain in 1979. CIA agent John Acuff of NICAP is replaced by retired agent Hall.

In 1979, a retired OSS agent claims during an interview that he was asked to kill General Patton. In January 18, 1979, a debate on UFOs took place in the House of Lords in England. On March 28, 1979, just as predicted, the Three Mile Island event took place. In October 1979, an altercation takes place between government scientists and military personnel and the resident aliens. Sixty six people were killed.

In Toronto, Canada in 1979, the RCMP admit to deliberately falsifying the medical records of political activist Ross Dawson. The police distribute false reports of Dawson's mental instability to discredit him with his followers.

In 1979, Charles Tucker, director of International UFO Investigative Bureau, says "UFO activity has picked up over 300 percent in the past six years. A poll of 8,000 members of astronomy organizations reveals that 23.9 percent have seen UFO's. J. Allen Hynek states that he has got over 1,500 reports from policemen over the past year. In a national poll, 68 percent say they have seen UFO's.

In June 1979, the book "Alternative Three" is released in the United Kingdom. A minister, William B. Gill, and 23 members of

a missionary school in Boinani, New Guinea, view a strange object hanging in the air a few hundred yards away from the schoolhouse. The object landed and crewmen were noticed walking on a platform on top of the oval shaped object. They waved back to the minister and his class after adjusting some equipment and then took off.

In 1979, Electronic Identification Research begins at Los Alamos National Labs for identification implants.

1980

In 1980, after his election, Ronald Reagan changes the 'Air Defense' in NORAD to "Aerospace Defense". The 'Roswell Incident' was published by William Moore. The MUFON journal publishes an article on Project Redlight. The Federal Emergency Management Agency conducts Rex-80 exercises, in which they relocate Cuban refugees as part a population relocation test.

In January 1980, Peter Gersten secures two documents from the NSA under the Freedom of Information Act. Gersten was able to find out on April 27, 1982 that some 238 NSA documents were located in the search that the government made.

In May, 1980, psychologist and researcher Leo Sprinkle regresses Myrna Hanson, who relates information about underground bases with vats. Also in May, Judy Doraty and her son witness a cattle mutilation and are abducted and implanted themselves.

In August 1980, disks intrude again into the Manzano Weapons Storage Area in New Mexico. On August 8th, A disk was discovered by a Sandia guard next to a building containing HQ CR44 (nuclear materials). On August 9th, a security officer checks down Coyote Canyon Road and discovers a disk.

By November 1980, researcher Paul Bennewitz was still being monitored by the NSA. In December 1980, the Cash-Landrum case occurred where both woman received severe radiation poisoning during an encounter with a US disk that is escorted away in full view of the two woman by 23 military helicopters. The disk that harmed the two women with hard radiation was a Project Redlight asset.

1981

In 1981, George Bush (former head of the CIA) becomes Vice-President and Ronald Reagan becomes President. The NASA R&D budget is \$109 million. Ronald Reagan was shot in an assassination attempt that wanted to put George Bush in office a little sooner.

In 1981, the University of Florida begins work on thought operated computers. The Stealth 117a aircraft was first test-flown. In January 1981, discovery of the Bentwaters/Woodbridge case featuring underground activities.

On January 13, 1981, Colonel Charles J. Halt writes a memo at RAF Bentwaters on the alien encounter in Rendlesham Forest.

On June 21, 1981, the Denver Post has an article by Gail Pitts on "Chip Implants that replace ID cards".

1982

In 1982, Peter Gersten of CAUS files a petition with the Supreme Court relative to NSA involvement in UFO related activities.

Researcher Linda Howe ("A Strange Harvest") was allegedly contacted by MJ-12 with ideas for making a documentary release of information - they changed their mind later. In 1982 the planetary population exceeds 4.8 billion people. On March 10, 1982, the House of Lords held its second debate on UFOs, still coming to no definitive conclusion. The Federal Emergency Management Agency conducts the Rex-82 exercise, which tested the national ability to mobilize quickly for wartime military production. Industry failed miserably.

1983

In 1983, a Nevada researcher discovers a metal rod in the center of a geomagnetic vortex in Blue Diamond, Nevada. The British government starts to release UFO files for the first time.

In 1983, the Stealth 117A fighter becomes operational on a covert basis. In 1983, the Colorado Advanced Technology Institute was created as a basic structure for future space oriented developments to take place starting in 1988-90. The memo of Colonel Charles Halt of Bentwaters is released in the United States. An internal Pentagon document dated December 1, 1983 describes in detail the military's directions for calling out the troops in case of some unspecified emergency. The document lists exceptions to the Posse Comitatus Act, the federal law that prohibits the military from operating in the United States. The document gives as its authority for such actions "the inherent legal right of the United States Government to ensure the preservation of public order...by force if necessary," a claim that the Supreme Court had dismissed when President Truman tried to use it to justify taking over steel mills in the early 1950's. There is evidence that new Army divisions, like those at Fort Lewis in Washington, will have a dual foreign and domestic role. Another planned division will be located at Fort Ord, California. FEMA has standby legislation in a bill innocuously titled the "Defense Resources Act". The bill would suspend the Bill of Rights, abolish free enterprise, eliminate privately owned property, and generally clamp the American people in a totalitarian vise. Section 202 of the bill, for example, allows the President to instantly confiscate any real estate or personal property "that shall be deemed necessary for national defense purposes". Section 501 authorizes the takeover of any industry the White House authorizes. Section 1213 outlaws all

strikes. The standby legislation also includes "Censorship of Communications," which allows the president, whenever he "shall deem that the public safety demands it," to censor "communications by mail, cable, radio, television , or other means of transmission." The "COG" (Continuity of Government) also exists. It is a secretive shadow government that is in place and ready to run the country.

Since 1980, this unprecedented apparatus has been installed to thrust the United States into a military takeover with or without the president's cooperation, and all in the name of preserving democracy from some unnamed threat. Guess what the threat might be?

In 1983, the University Hospital Medical Center in San Diego reviews a skull x-ray in which they claim that brain transmitters were found.

In 1983, J. Allen Hynek begins to investigate CEIII incidents. Hynek says " It was the people themselves who changed my mind about UFO's - good solid people. It was time to change my attitude".

On September 1983, OMNI magazine hosts an article about a nuclear powered tunnel boring machine developed by Los Alamos laboratories.

1984

The movie "V" is presented to the public, portraying reptilian aliens who feed on human flesh, store humans for food, etc. Active resistance groups are also plugged in the movie/series. NASA budget is \$192 million. The book "Clear Intent" is published by Fawcett and Greenwood. The Soviets conduct a national poll on UFO experiences, to which 30,000 reply. The Federal Emergency Management Agency conducts the Rex-84 exercises. These exercises have been held every two years since 1978, and test the federal governments emergency plans against hypothetical events. This exercise was involved with practice in detaining and handling large numbers of people. Large numbers of people might presumably have to be dealt with after a controversial government action. Any guesses?

On April 26, 1984, General Bond is killed flying in Area 51 during a classified aerial test. In December, the US Space Foundation held its first Annual National Symposium in Colorado.

In September, a high delta-wing craft soundlessly buzzes golfers in Australia and sets Royal Australian Air Force into motion. The event caused the subject of UFO's to be raised in Parliament.

In 1984, the movie "Adventures of Buckaroo Bonzai in the Eighth Dimension" is released.

1985

In 1985, McDonnell Douglas receives brand new engine technology from apparently nowhere. John Herrington becomes Secretary of Energy. The Soviets reveal major encounter data to the public. Author Ralph Noyes (UK) publishes "A Secret Property" about the British Government and UFOs. NASA budget has grown to \$248 million for research and development. Lawrence Livermore labs begins to manufacture artificial blood, some of which is destined for Dulce Genetics Facility in New Mexico. Cattle mutilations begin to drop off in the Midwest.

On August 5th, Scientist Paul Bennewitz observes the crash site of a US Black Delta ship in New Mexico.

In October 1985, Aries Properties acquires 21,000 acres running next to Colorado Springs, site of a future space technology center.

In November 1985, NBC broadcasts a program about "black unmarked helicopters, secret projects, and bad money." On December 4, 1985, president Reagan voices thought about alien forces from space to high school students.

1986

In 1986, "Sky Crash" by Jenny Randles and "UFO Crash at Aztec" by Steinman and Stevens are published. The Brazilian Air Force, according to government documents released by the FOIA, chases UFOs. Project Snowbird goes into another phase to develop craft with conventional technology to show to the public. Crime rate rises 5.2 percent.

On July 26, 1986, Dr Robert I Sarbacher dies.

In 1986, the movie "The Aurora Encounter" is released.

1987

In 1987, Star Wars budget is \$4.2 billion. The Department of Defense now funds 75 percent of all Federal Research and Development.

A Los Angeles policeman dies after discovering a major CIA distribution point for heroin and cocaine at the top of the Staffers Concourse Hotel in Los Angeles and is killed. Funds created by the agency are funneled to covert projects. Other distribution points exist at Riverton, Wyoming and on the Laguna Indian Reservation in Arizona. Delta Security forces provide protection.

In 1987, the "Dulce Papers" are first released. Data on five entrances to Dulce lab is leaked, and the government takes care of them by destroying buildings and building new ones in odd locations for apparently no perceivable reason.

In February 1987, there are 102 operable nuclear facilities in the United States. On February 15, 1987, the San Jose 'Mercury' reports on the Pentagon "black budget" program.

In February, a national Gallup poll indicates that 88 percent of the population of the US has heard or read about UFO's. Nine percent, or equivalent of 19 million people, indicate that they have seen a UFO.

On April 27, 1987, genetically altered bacteria are publicly released. The bacteria were produced to interfere with 'frost damage to citrus crops'.

In September 1987, 16-cycle waves are broadcast from transmitters and repeaters for a period of four months before the election of George Bush. The ELF waves cause entrainment of millions of Americans to occur, possibly to influence the election. Allegedly, the main transmitter was located in Nevada. On September 4, 1987, the group called "Justice for Military Personnel (JMP)" sends a letter to the president, detailing crimes the military has been ordered to commit against private citizens in regard to the alien problem.

On September 21, 1987, Reagan again voices his thoughts about aliens threatening the earth in an address to the United Nations.

On October 11th, the Las Vegas Review Journal reports a story on Area 51/ Dreamland in Nevada. On the 17th, large numbers of B-52's were seen taking off from Hickam AFB, Hawaii. On the 20th, William Moore visits Albuquerque, New Mexico.

In 1987, the National Research Council calls for an immediate effort to develop a genetic linkage map as the first goal of the human genome project; the National Institute of Health and the Department of Energy draft a 5 year plan to go before Congress.

On November 21st, the Parkinson Institute begins asking the public for human fetuses to study. Requests are made to groups of hospitals. On the 27th, groups of US Army rangers attempt and apparently bungle an attempt to enter a joint alien facility in New Mexico. In December, the CIA begins to contact everyone who was ever in its employ that ever had anything to do with the alien problem. A woman draws a picture of a black-mirrored spherical craft she says belongs to the National Security Agency. On the 14th of December, John Lear offers to host the MUFON Convention in Las Vegas in July 1989.

On December 17, 1987, a UFO in Gulf Breeze, Florida drops a fluid on the local athletic field. Walt Andrus has GBRA labs in Seguin, Texas do an analysis. The analysis shows that the fluid is of unknown origin. Andrus does not distribute the report. A Gulf Breeze resident mails a copy of the report to NAR.

1988

George Bush finally becomes president. A joint alien base off the Florida coast is reactivated, giving rise to the sightings at Gulf Breeze. On March 25, John Lear releases a statement to the public on the status of affairs with the alien situation. On April 27th, Leonard Stringfield speaks at a Milford, Ohio public library.

In 1988, the Strecher Memorandum about AIDS is distributed. The video details how AIDS was created as an intentional retrovirus mixture of bovine lukaemia virus and sheep visna (brain-rot) virus.

Strecher also details how AIDS appearance was directly connected to World Health Organization vaccinations in Africa and New York Bloodbank sponsored Hepatitis B vaccinations in the United States. He also detailed how over 300 releases of biological substances on the US public have occurred, primarily by military and intelligence agencies. The tape exposes some myths about AIDS, and also how the virus, which is crystalline in structure, can be destroyed in the body by exposure to RF frequencies that match the viruses mortal oscillatory frequency. Vaccines cannot be developed for a virus which has 5.6×10^{15} possible combinations. AZT eats away the human body as well as part of the virus.

In 1988, a television commercial from Motorola, the company that developed and suppressed the 3-D television in 1966, announced development of nanotechnology, parallel programming, and implanted chips that interact directly with the brain. Their technicians had no doubt it would come to pass, and with perfect blindness to its implications.

In May 1988, Reagan again makes a speech in which he refers to an "alien threat from outside this world". Newspapers report Reagan has been allegedly "warned" by astrologers that there will be a space invasion by 1993. It was discovered that EBE's are sensitive to any material having a left-hand atomic spin. On May 5th, Leonard Stringfield releases an article in Batavia, Illinois about aliens.

In June 1988, President Bush proposes to convert old military bases to prisons. On August 8th, "The Matrix" by Valdemar Valerian is released. In September, William English re-emerges into the public eye. On October 14th, "UFO Coverup...Live" is aired from Washington.

On November 12, 1988, Senator Cranston is allegedly shown disks at Norton AFB. General Electric and IT&T are two of the contractors involved in building the disks. General Electric also owns NBC. One of these disks would get shot down by the South Africans in May 1989. The publication "NASA Techbriefs" shows a photo of an EBE with no caption or explanation. Word comes from New Mexico to researchers that Los Alamos has developed an antimatter weapon, which allegedly will be used as a last resort if "the Greys cannot be pried away from the planet". The number of Greys on Earth is estimated at 20 million. In December, Steven White (President of Bechtel Investments) dies. Bechtel has been heavily involved in underground construction and is the world's largest construction firm.

DRAWING RECEIVED IN 1991 OF THE CRAFT SUPPOSEDLY SEEN BY SENATOR ALAN CRANSTON AT NORTON AIR FORCE BASE IN CALIFORNIA.

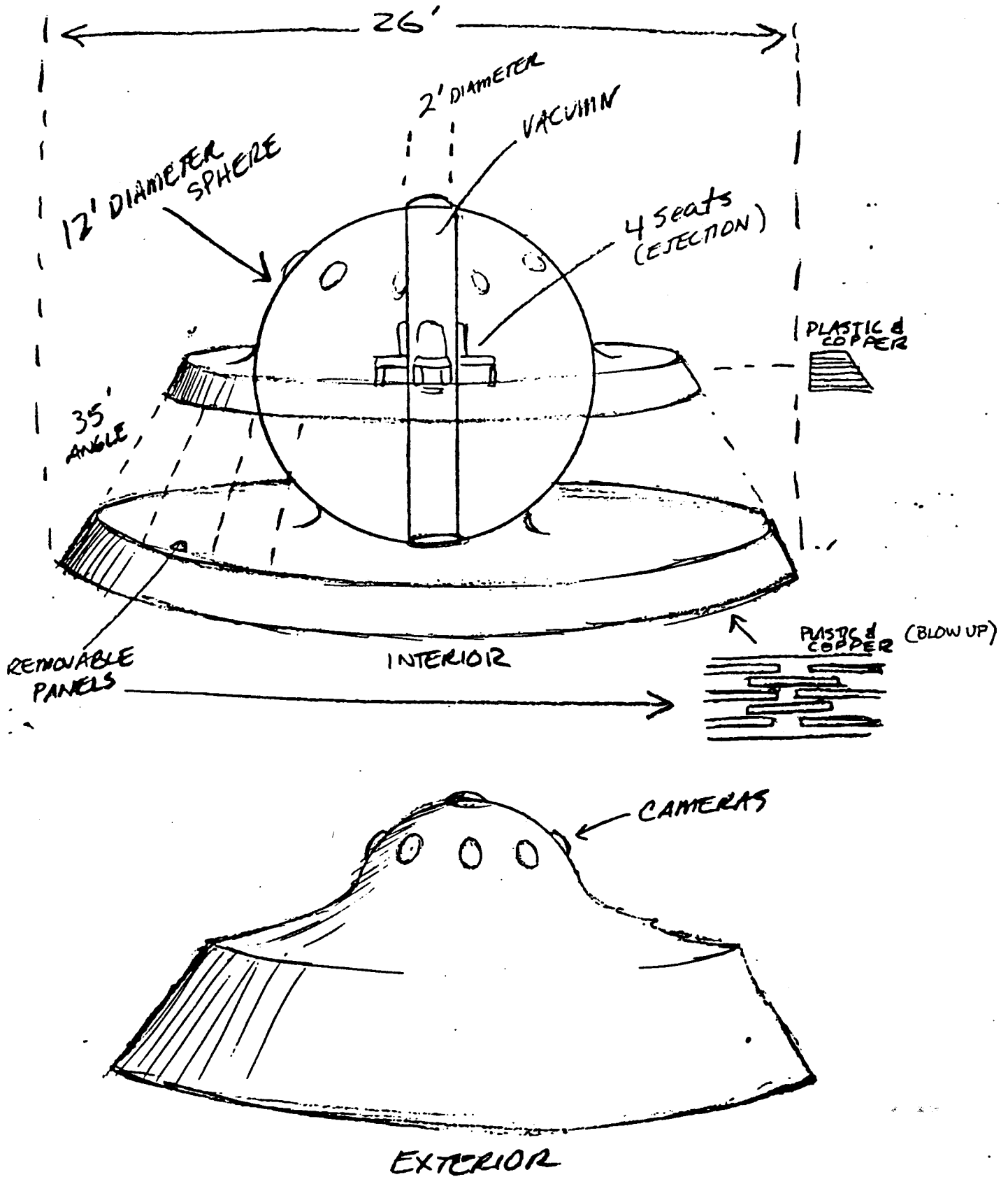

In November 1988, HR5210 is signed into law by the president; it severely weakens 4th amendment rights. The no-knock law.

Bo Gritz, one of the most decorated Green Berets in American history, distributes his book "Betrayal of a Nation", detailing the CIA as one of the biggest purchasers of heroin and cocaine, as well as the use of Delta forces in drug deals.

Information comes forth that the intelligence agencies are distributing drugs to finance alien-related projects, which demand phenomenal amounts of money.

In December, Swedish astronomer Emil Lundstrom of Gotebord Sweden sights an hour-long procession of disks flying across the face of the moon. It was estimated that the disks were 600 feet in diameter and travelling 1,200 mph.

1989

In 1989, the Planetary Science branch has a \$10 million budget cut, which prevents analysis of planetary data gained from NASA planetary missions. There will be no 1990 money available to analyze Project Galileo data.

Starting in 1989, billions of dollars are being spent modernizing NORAD. Data on Project Excaliber is released. The project is involved in developing a warhead that will penetrate 1000 meters of earth and then detonate. Useful for destroying underground bases.

1989 is the year that Zbigniew Brzezinski predicted that the United States Constitution would be rewritten. In January 1989, William Cooper and John Lear issue an indictment to the president regarding the alien problem. No reply was ever received.

In 1989, Cetus corporation makes a major scientific breakthrough in genetics called a polymerase chain reaction (PCR), which allows researchers to reach into genetic material and make copies of DNA. This frees researchers from having to grow cultures.

On January 30th, a lawsuit was filed which challenged the planned use of a foreign gene in an experiment to be conducted on ten patients with melanoma cancer. The suit said that the National Institutes of Health Recombinant DNA Advisory Committee approved the experiment without conducting public hearings. The NIH is supposedly the only agency in the country that can approve experiments to change the human genetic makeup of the human being.

On February 26, 1989, William Cooper and John Lear send copies of the Indictment to 536 members of Congress. There are 2 replies.

In March 1989, the Soviets lose a Mars probe link. In April, scientists report a "breakthrough in cold fusion". On May 13, the series "War of the Worlds" presents the ideas of implantation of

alien cellular material in humans, as well as the use of sonic weapons against aliens. Also in March data regarding a sonic weapon development program called Project Gabriel is received by way of William Cooper. Gabriel is a sonic weapon.

On March 14th, a MUFON ham operator monitoring a space shuttle flight, heard "Houston (from) Discovery, we still have the alien spacecraft under observance". Analysis showed high probability that astronaut voice was that of Bagian, a crew member. Monitoring occurred on 145.450 MHz. Further voice verification is in progress.

In April 1989, the US Department of Justice awards \$750,000 to nine people who were unknowingly subjected to CIA-funded brain-washing experiments in the 1950's. The research, performed on the patients when they sought psychiatric treatment, included using intensive electric shock, sensory deprivation, hallucinogenic drugs, barbiturate-induced sleep, and continuous exposure to taped messages.

The patients were left confused, dazed, incontinent and panic-stricken.

In April 1989, the CIA creates a counternarcotics center and staffs it with over 100 agents and analysts and assigned them to anti-narcotics efforts in line with the Bush Administrations public "war on drugs". The CIA continues on its own, covertly, dealing hard drugs in order to raise working capital for technical and intelligence projects.

On April 28th, the Washington Post News Service reports that the Department of Defense has successfully tested an experimental space vehicle designed to destroy "incoming missiles". The 21 second flight took place inside a cavernous Air Force laboratory at Edwards AFB in California. The Pentagons SDI office said the test boosted efforts to develop and deploy the first phase of a much larger space-based defense network.

In May 1989, Houston journalist Paul Harasim writes a biting review of the John Lear lectures in Houston. It is an article which results in the dismissal of Lear from ATA in June.

Also in May, the Defense Investigative Service continues their probe into just how much ufologists know, interviewing several researchers in California. On May 7th, the South Africans shoot down a disk. US Military pilots exit and South Africa complains about invasion of airspace by the US. The disk is taken to Wright Patterson AFB and then to Kirtland AFB in late October in order to be analyzed by Sandia Labs. The incident is revealed to the public in October 89.

On May 13, 1989, the television program "War of the Worlds" conveys the concepts of aliens implanting cells in humans, and the use of sonic weapons against aliens.

On May 14, 1989, Las Vegas channel 8 TV televises an interview with a government scientist working at Groom Lake and Dreamland. The scientist openly tells of nine disks on the Nellis range; three of them are operational; the craft use antimatter engines; the Soviets were involved only up to a point. He won't talk about the aliens.

Subsequently, the government scientist discovered that he has been the victim of a method of hypnosis known as "Orion Hypnosis". His life is threatened and his car is shot up in Las Vegas.

On May 16th, a court agreement cleared the way for the first publicly authorized human gene transplant. The agreement requires NIH to open future decision-making on human gene experiments to the public.

On May 24, Linda Howe's book "An Alien Harvest" is released. On May 27th, "War of the Worlds" presents ideas to the public about aliens producing substances to contaminate human food as humans produce bacteria to counter the aliens.

On June 10, 1989, "War of the Worlds" presents ideas to the public about humans decoding information about an invasion; that invasion will happen in 'four years'; aliens infiltrate human resistance groups; aliens are acquiring chemical weapons.

On June 3rd, "War of the Worlds" presents ideas to the public about blond aliens helping humans to defeat the aliens in battle

On June 7th, American Transair dismisses John Lear for confirming that alien data is true. Lear goes to work for another airline.

On June 17th, Dr. Barry Taff speaks in Santa Monica about UFOS.

On June 10th, the television program "War of the Worlds" conveys the concepts about an alien invasion in four years, humans decoding alien transmissions about invasion, alien infiltration into human centers of resistance, and alien acquisition of chemical weapons.

On June 30th, after a spree of what were possibly government induced violent episodes with guns and schoolyards (mind control on a psychiatric patient) the government presents gun legislation to Congress in an attempt to disarm the American public before major authoritarian measures could be imposed at a later date. Americans balk at this.

On June 30, July 1st and 2nd, the MUFON Conference occurs in Las Vegas, Nevada. William Cooper, John Lear, William English, Don Ecker speak to an enthusiastic crowd. The day before, on July 1st, William Moore and a disgruntled audience have a shouting match with each other. The audience is astounded when instead of the issues at hand, Moore uses his time to attack other researchers, specifically Paul Bennewitz. William Moore publicly admits he works for a government intelligence agency. Klass gets his tape recorder taken away at the conference.

In July, a tape of the Lear-Cooper interviews is distributed in Europe and Scandinavia. Mass movements of material on trucks begins at the Nevada Test Range, with vehicles moving north.

On July 20th, George Bush makes a public announcement that he will seek to commit the US to building a manned outpost on the

Moon (where they already have them covertly) and sending astronauts to Mars (where the US has already been covertly involved since the 1970's). Bush makes major space policy speech. NASA says that such a project will more than double its budget, pushing it above 2 percent of the Federal Budget.

On July 29th, KLAS TV in Las Vegas shows a one hour special featuring interviews with William Cooper and John Lear. The station receives an overwhelming public response.

Also in July, Bush Administration drug czar William Bennett proposes Spartan style boot camps for non-violent first offenders to "jolt them into straightening out their lives". Bennett also proposes fines, weekends in jail, loss of automobiles and loss of drivers licenses for casual users.

The Bush administration decides to send military forces to the mideast to confront "terrorists" on August 4th.

On August 5th, national networks announce the series "Alien Nation" will begin in the fall. The movie by the same name came out about one year previously. More public acclimation efforts.

On August 7th. US News and World Report publishes material on "Americas Doomsday Project", detailing over 50 underground facilities that are for use during time of crisis.

In September 1989, several west coast radio talk shows begin avid discussion of UFO's, aliens and interaction with the US Government.

The public discussion is now out of control. On September 23, 1989, a two-hour documentary is screened on Japanese television.

Viewers are treated to the full spectrum of recent investigations, including underground labs, MJ-12, genetic facilities, the Kennedy murder, the voices of the astronauts on the shuttle talking about observing alien spacecraft, the EG&G scientist talking about the disks at Groom Lake, and a visit to Dulce, where residents tell of visits from the CIA. A CIA or MIB type is photographed following the Japanese news team. His Colorado license plate is readable.

On September 27th, three disks land in the Soviet Union. One lands at the 70th parallel near the arctic circle, one lands near Moscow, and the third 300 miles south of Moscow. The disk has the Cyrillic UMMO symbol on the bottom. Apparently all three disks bore the symbol. It is thought by researchers that these disks belong to or are associated with the Soviet Government . It is a known MJ-12 tactic to use the Soviet Union . The landing and debarkation from the third disk is jointly reported by TASS and the press in the United States on October 8th , making the first time a worldwide conditioning experiment has occurred. On October 11, 1989 a large disk was seen by hundreds of witnesses in eastern Oklahoma. The disk was also videotaped and photographed. Sightings begin to be reported in Iowa and around the United States in large numbers.

In October, researcher William Cooper indicates that research into underground/inner earth is a waste of time and draws attention from

the more important issues. Most researchers do not agree. The Army CID engages an agent with the codename "Scott" to interact with the Billy Goodman show in order to attempt to discredit Cooper. "Scott" claims to be an investigator, but won't give anyone a way to contact him, but wants people to send him information indirectly. Even Goodman is suspicious.

On October 15th, researchers relate that the television series "Alien Nation" gives a good portrayal of the species known as the 'orange'. Disinformation expert James Moseley sends his newsletter, "Saucer Smear", trying to cause confusion among researchers by announcing that "underground bases are fantasy" and that some prominent researchers are 'aliens in disguise'.

On October 16th, word comes from researchers that the United States and the Soviet Union had a disagreement on the base on the far side of the Moon in which several US scientists were machine-gunned. This disagreement reflects the split between the US and the Soviets detailed in the May 89 disclosure by a government scientist working at the S-4/DREAMland facility in Nevada. It is thought that this disagreement occurred in 1986 or 1987.

On October 17th, the "War of the Worlds" series acclimates the public to the idea of clones being programmed with memories from their original templates. Passive security code-named "Yellow Fruit" (Area 51- Dreamland) gives a talk on KORNG radio in Los Angeles.

On October 22nd, intelligence expert William Cooper gives details about the South African disk incident in May 89 over KVEG in Las Vegas.

On October 25, the American public becomes aware of the South African incident in May. Congress works on legislation to make radio talk shows liable for statements made by callers in an effort to shut down talk radio programs, where UFO/Alien data is being avidly discussed. The national program *Inside Report* details mass-witnessed sightings of disks in southeastern Oklahoma.

On October 26th, William Cooper goes on a radio station in Los Angeles and tells the listening public that President Bush is involved in the drug scene. The FCC attacks the talk show host the next day for "saying a bad word". Researchers speculate that the Secret Service, who allegedly terminated Sal Mineo during Reagan's administration because of an alleged homosexual tape they were concerned about, will seek to eliminate Cooper, that for some reason Cooper has now made himself expendable with this material involving the President.

On October 28th, the War of the Worlds series introduces the concept that specific frequencies are transmitted in rock music that affects humans and makes them more vulnerable to control.

On October 30th, researchers manage to get ahold of government documents in California that detail the incident with South Africa and the US disk. The national program *Hard Copy* televises a program in which they examine the idea of Whitley Streiber as a cult leader.

In November 1989, a C-5 Galaxy lands at Dover AFB, Delaware, loaded with cocaine. DEA gets wind of it and tells the public it arrested a crew member with personal amounts of cocaine. The cargo vanishes.

On November 2nd, researchers at Blue Diamond area outside Las Vegas spot a large disk over the area.

On November 3rd, word comes from researchers in California that Marineland, which shut down operations years ago, is being used as a Navy Biological Experimental Station. The government has been apparently renting the former Marineland compound from the owner, Monohan Corporation, ever since park closed. Researchers managed to penetrate security enough to discover that the government is doing toxic viral and bacteriological experiments on animals there - right in the middle of Palos Verdes, California. Black helicopters with FBI personnel survey the area. The helicopters are equipped with a long ten-foot rod, which is believed to be a biological sensor, capable of picking up lifeforms. Researchers also point out connections between the owner of the facility and organized crime, which has a direct intermix with the CIA, who are the gentlemen in the expensive black suits that come out to meet you. UFO are also seen around the facility.

In November 1989, animal and cattle mutilations begin to accelerate, after a 14 year slowdown.

Also on November 3rd, researchers announce their discovery that "Yellow Fruit" security team was started back during the Carter Presidency, and was part of the ISA. It has been periodically disbanded and has existed in one form or another since the Carter administration. Los Angeles radio talk show host Ken Hudnell announces his intention to take a group to visit one of the ancient underground cities, which he says has an entrance 60 miles from Anaheim. Researchers discover the passive security frequencies at Groom Lake; 138.306 and 407.550 and that a group codenamed Seaspray is involved with primary security in the area. Security forces then change the frequencies.

On November 4th, word comes from Japan that the huge Japanese trading company Marubeni acted as a go-between for the Australian Government and locals in the purchase of a huge tract of land in Australia. As soon as the deal went through, a literal man-made mountain was built in an all-too-obvious attempt to hide something very secret (say local researchers).

On November 6th, Channel 8 in Las Vegas starts a two-week series on Area 51, animal mutilations, and the UFO coverup.

On November 10, EG&G scientist Robert Lazar goes on television and tells what he knows about US disk technology at S-4 in Area 51, including information about 9 US disks, antimatter reactors, and mind control for S-4 scientists.

On November 11, 1989, the network program *Secrets and Mysteries* televises "UFOs on Trial"

On November 13, 1989, *Inside Report* televises "Alien Inspiration", about a couple in Nashville Tennessee that receives channeled music they believe is from space entities.

On November 17, 1989, Current Affair televises a program in which a Greenville, NC home video shot of disks in the night sky also catches alleged ETs in an apartment window.

On November 19th, an electrical worker at Mercury, NV, calls the Billy Goodman show and describes tunnels 3000 feet under the test site that have stainless steel walls and elevators. He also describes small Grey bodies on gurneys being wheeled down the tunnels.

On November 20th, a security guard on the Nevada Test Site describes his contact with a man in black that describes the whole alien scenario to him. The man had transparent eyelids.

On November 20 and 21st, the national program *Hard Copy* televises two programs on UFOs. EG&G scientist Robert Lazar goes on radio on KVEG for three hours and answers questions over the 50,000 watt station. Another three hour session takes place Nov 24th and 25th. Robert Lazar publicizes the name of his boss at Area S-4, tells that 22 people work at S-4, and how antimatter reactors work. Indications are that more people will be coming out of the woodwork to tell what they know up at Area 51.

On November 21, 1989, John Lear comes back into public view on a four hour talk show on KDWN radio in Las Vegas. Lear goes into detail about the AIDS conspiracy .

On November 24th it is announced on the radio that Vice President Quayle announces a US objective to have a manned nuclear powered permanent base on the Moon by 2003 and a manned mission to Mars by 2011. A new book about the Kennedy Assassination, Crossfire, is profiled. The book exposes the deceit in the Kennedy assassination, and how President Johnson sealed the records until 2039 to prevent any intrusion. Only another President can unseal the records or reopen the investigation. Crossfire release date is slated for December 1st.

On November 25th, television station Channel 8 in Las Vegas televises a two hour special on UFOs, Area 51, S-4 and the UFO coverup. It is revealed that some people who contacted Channel 8 had had their homes broken into in Las Vegas.

On December 6th, "The Secret Files of J.Edgar Hoover is aired in a two-hour special, revealing the misdeeds of the administrator during his tenure as director.

During the week of Christmas, 1989, it was reported that there were a series of very large underground explosions in the area of the base at Dulce, New Mexico. A month earlier, animal mutilations began to pick up significantly. The last time these two events occurred in this order was when the government first discovered what the Greys were up to and they tried to go in and stop them. Over 60 Delta troops were killed in the process.

1990

In January 1990, two pilots overfly Area 51 during Redflag exercises and are immediately shipped out.

On January 11th John Lear speaks at a Las Vegas high school to raise money for the high school science club.

On January 19th, it is announced on the national news that there are plans to implant both children and pets in a national "finder" program.

In January 1990, William Cooper reveals on KVEG radio that US disks were involved in transporting people to sabotage the helicopters for the ill-fated Iran hostage rescue in Carters administration.

Also in January, witnesses in Lancaster, California view a delta shaped craft 900 feet long fly slowly over a ten minute period over the city. The craft was accompanied by a disk.

Crest International issues a publication that details British investigations into the South African crash of a US disk in May 89.

In February 1990, discussions are heard on the radio about implant identification chips for pets and children.

On February 1st, more than 700 scientists, including 49 Nobel Prize winners, accuse President Bush of being complacent about the threat of global warming.

On Feb 2nd, President George Bush forms a high-powered scientific advisory group which will be the first to report directly to the office of the President in 15 years. The council consists of 12 men and 1 woman. Bush also unveiled a record \$71 billion research and development budget.

On February 17th, a Ukranian astronomer detects radio emissions near Altair, which in ancient times was associated with reptilian creatures.

In February 1990, the George Knapp 2 hr. special is aired again in Las Vegas, Nevada.

On March 3rd, Las Vegas UFOCCI chairman Stacy Borland and her brother were brutally murdered while at home.

On March 8th, the final destruction of the 4th amendment of the constitution takes effect very quietly behind the scenes. Now the authorities need no warrant or probable cause to break into a persons home and perform any action they think fit. Suspicion is sufficient.

On March 10th, the television series "War of the Worlds" reruns the program featuring cloning using crystalline technology and engramic memory.

On March 16th and 17th, researcher Budd Hopkins speaks at the Spring Valley Library in Las Vegas, Nevada to a packed house.

INDEX

DESCRIPTION	PAGE
Abductee breeding categories	146A
Abductee conditioning practices	39
Abductee Government Agent Handler Program	130
Abductee merging consciousness with human body	109,135
Abductee reactions to hybrid breeding efforts	118
Abductee reports underground facilities	176
Abductee selection as a donor	138
Abductee training	139
Abductee training programs	118
Abductee, attitudes towards others afterward	144
Abductee, childhood retrieval	328
Abductee, letter about physical scars	170
Abductee, on table with instruments	203
Abductees and brain implants	106
Abductees and Implant Devices	325
Abductees as a Sleeping Army	106
Abductees first taken as children	118
Abductees located through resonance	56
Abductees, implant connections between	116
Abductees, infections from abductions	121
Abductees, training on alien equipment	56
Abduction and sleep disorders	141
Abduction case similar to Christa Tilton	127
Abduction experiences over other lives	117
Abduction in the media - 1967 comic	125
Abduction of Christa Tilton	126
Abduction of Fort Ord troops in 1961	107
Abduction of human females for cross breeding	54
Abduction related bodily injury areas , drawing	124
Abduction related medical anomalies, list of	123
Abduction, appearance as childhood molestation	144
Abduction, child examinations by aliens	142
Abduction, effects of	140
Abduction, effects on relationships	145
Abduction, embarrassment of children abducted	144
Abduction, major effects of	115
Abduction, memory blocks	115
Abduction, memory loss	116
Abduction, multi-level involvement scenarios	154
Abduction, physical trauma with	115
Abduction, psychological problems arising from	140
Abduction, responsibilities of researchers	146
Abduction, Service to Self scenarios	114
Abduction, sexual themes	145
Abduction, Villas Boas	410
Abduction, women having "dummy births"	144
Abductions and fear of dreaming	141
Abductions and panic disorders	142
Abductions during time of Charlemagne	374A
Abductions, aliens induce orgasm	144
Abductions, anomalous euphoric state after	142
Abductions, fear of open spaces and isolation	142
Abductions, fears of medical facilities	142
Abductions, feeling of isolation	145
Abductions, female infections from	140
Abductions, multi-generation	154
Abductions, multiple	106
Abductions, multiple witnesses of	106

DESCRIPTION	PAGE
Abductions, psychological approaches to helping	145
Abductions, purposes of	243
Abductions, sexual components of the experience	141
Abductions, the Government Factor	129
Abductions, vaginal or naval discharges	140
Abraham Lincoln as a believer in the people	5
Access disruption and sabotage	24
Acclimation program	4
Activities that have stopped abductions	154
Acuff, John, approached by KGB	419
Acuff, John, CIA operative, NICAP	415
Acupuncture meridian system	157
Adamski, George	413
Adrian, story of a Grey Walk-In	109
Advanced technical developments, Navy	301
AEC 1950 suggestions for underground facilities	179A
Agreement between Govt and Aliens	3
Agreement, all is done by, concept of	338
Agreement, first with aliens in 1934	400
Agreement, violation by aliens	3
Agreements by the abductee, high level	152
Agreements made with aliens, dates of	52
AIDS	11
AIDS creation	267
AIDS, aliens resolving cases of	115
AIDS, commentary by John Lear on	261
AIDS, radio emission destruction of	426
AIDS, spread of	426
Air Force technology and corporate connections	300
Akashic record	345
Akhnaton, starter of monotheism	374B
Alcyone system, entity from	101
ALF	69
Alien autopsy description	66
Alien based human control methods of Elite	374H
Alien bodies at Wright Patterson AFB	70
Alien breeding facilities	206
Alien claims to create Christ	248
Alien colonists	18
Alien Contact Facts and Considerations	6
Alien control process	324
Alien control web	98
Alien custodial religious programming	374D
Alien genetic hybridization	121
Alien influence and human disease	374E
Alien interaction, categories of	9
Alien life forms, communication with, computers	105A
Alien Manipulation Networks	326
Alien manipulation, vulnerability to	121
Alien meeting at Holloman	69
Alien meeting at Homestead AFB	69
Alien mind control	54
Alien motives for abductions	39
Alien plans for genocide of humans	103
Alien races, deception strategies of	28
Alien reaction to abductee emotional responses	147
Alien relationship to Earth Humans	7
Alien species, Service to Others	104

DESCRIPTION	PAGE
Alien species, Service to Self	102
Alien strategy, overcoming	20
Alien Technology Division	213A
Alien technology exchange	137
Aliens and The Government	1
Aliens Categorized by General Motivations	7
Aliens from dying planet	12
Aliens in conflict for control	98
Aliens masquerading as humans	79
Aliens masquerading as humans, Grey droids	79
Aliens masquerading as humans, Grey MIB	79
Aliens masquerading as humans, Nordics	79
Aliens masquerading as humans, Pleiadeans	79
Aliens who are social 'plants'	79
Aliens, hump-backed	408
Aliens, traveling in time frames and densities	104
Aliens, tuning in on human emotions	103
Alliance between aliens and secret government	11
Alternative 1,2 and 3	409-410
Alternative 3, release of television program	419
American citizens, covert PSYCHOPS against	418
American Indians and tunnel to Tiahuanaco	373
Analytical mind, definition of	365
Andreasson Affair	322
Andreasson Affair, implantation during	328
Andrus, Walter	11
Animal Mutilation Conference	420
Animal mutilation locations, map of	178
Animal Mutilations	84,100A,177
Anti-alien weapon development by military	19
Anti-alien weapons	20
Anti-christ	19,20
Anti-christ concept	13
Anti-matter weapons at Los Alamos	426
Apocalyptic predictions are alien tool	15
Appearance of comets and plagues	374E
Area 51	254
Area 51, accidental overflights	434
Area 51, letter from Senator Reid on	216
Arkansas, sightings and tunnels	176
Artificial brain matter, generation by aliens	84
Aryans, the	374C
Ashtar	10,11
Astral body	161
Astral soul	164
Attainment of goals	350
Attention Unit, definition of	369
Aurora, top secret aircraft called	254
Autopsies of some alien beings	66
Awareness and choice	136
Awareness of Awareness Unit, definition of	369
Awareness, definition of	369
Awareness, group, description of	344
Axis shifting	322
Bank of International Settlements	370B
Bar, flashing lights used to entrain brainwaves	93
Basel, Switzerland, banking control from	370B
Bashar, entity known as	357

INDEX

DESCRIPTION	PAGE
Bavarian Illuminati	374E
Beacon abductees	116
Bechtel Corporation and underground facilities	411
Beings below the surface of the earth	169
Beings on Earth with whistling language	372
Belief contradictions in brainwashing	27
Belief systems, applicability of	343
Bender, Albert K., IFSB	407
Benevolent aliens claims	12
Benevolent Ones	108
Bennewitz, discovery of alien activities	419
Bennewitz, documents investigating	105X
Bennewitz, Paul	68,205
Bennewitz, Paul, comments by John Lear on	260
Bennewitz, Paul, Studies on Alien Cultures	105A
Bentwaters AFB	238
Bentwaters, early incident in 1950's	409
Betelgeuse aliens	12
Bethesda Naval Hospital mind control projects	403
Bethesda Naval Hospital, death of McCarthy	409
Bilderburgers, part in alien problem	406
Biofields used as carrier waves for control	329
Biogenetic research at Los Alamos	202
Biological warfare against aliens, development	21
Biological warfare tests, Canadian	406
Biological weapons in ancient India	372
Bjork, Kristie	170
Bladder, breeding, with aliens inside	192
Bladders, alien breeding	191
Blocking of spiritual recovery for humans	374B
Blocks, dealing with psychic	120
Blond contact, apparent purpose	108
Blond humanoid contact	107
Blond humanoids engineered by the Government	108
Blond humanoids working with Greys	115
Blond-Grey conflict	370
Blue ray, alien use of	100B
Bo Gritz, POWS and Drugs	4
Bodies in Pawn	324
Bodies, alien, storage in Albuquerque	105D
Body separation with static charges	120
Bolivian legends	371
Bond, General, killed at Area 51	423
Brain nullifier device produced by Army	415
Brain transmitters, X-rays reveal	423
Brain, mind, and focus	349
Brainwashing and beliefs	26
Brainwashing techniques	26
Brezzezinski, Zbigniew	427
Brookhaven Research labs	400
Brotherhood influence in India	374C
Brotherhood of the Snake	374B
Brotherhood of the Snake, corruption of	374B
Brown, Thomas, electrogravitation research of	407
Bullard, Thomas, studies of	1
Bureau of Land Management BLM transmitters	235
Bush, George, biological and chemical warfare	374J
Bush, George, conversion of military bases	426

INDEX

DESCRIPTION	PAGE
Bush, George, director of CIA	418
Byrd expedition to South Pole	409
Byrd, Richard, 1929 polar expedition	399
Cabbit, the genetic mutation called the	89
Calvert, Texas	168
Calvinism, effect of	374F
Canadian Bill of Rights, suspension of	416
Canadian biological warfare	406
Cascade Mountains	100
Cash-Landrum incident	421
Cash-Landrum lawsuit over US atomic craft	212A
Caste systems imposed	374C
Casual body	162
Catechimine Beta-Lipotropin 4753	93
Cathie, Bruce, earth energy grid systems	413
Cavern city complexes	96
Caverns, war of, concept briefing	298
Caves and caverns, USA, map of	186
Central Asian legends	374
Central Security Service, creation of	417
Cetus Corporation	427
Chakra system diagram	323
Chakras and nadis	159
Change, people attracted to that which produces	364B
Channels as contactees	134
Characteristics of control used by suppressives	370C
Child as bridge toward multi-dimensional self	364A
Children as future targets of abduction	152
Children, abduction and puberty	144
Children, Abduction of	150
Children, attitudes toward	144
Children, avoidance by abductees	144
Children, human, Grey reaction to	152
Children, human, Reptilian species reaction to	152
Children, sacrifice of]	100C
China Lake, disks at	415
China Lake, Navy installation at	300
Chinese extraction of aluminum 1,600 years ago	373
Christ consciousness	104
Christ return scenarios	20
Chromosomes and Species Alteration	393K
Chronology of Human and Alien Interaction	396
Chronology of Psychiatry and Eugenics, US & Nazi	311
CIA	2
CIA and drug financing of alien projects	427
CIA and LSD programs	406
CIA and mental hospitals	303
CIA and National S&L failure scandal, 1990	395B
CIA and opium traffic	412
CIA and recruitment of dupes	302
CIA and ultrasonics research	418
CIA and worldwide opium traffic	420
CIA as based in Nazi SS Intelligence	4
CIA brainwashing experiments, lawsuit on	428
CIA control over worldwide opium	420
CIA drug distribution points	424
CIA experiments with LSD in Canada	410
CIA funded Canadian mind control experiments	410

DESCRIPTION	PAGE
CIA mind control program targets	416
CIA MK-DELTA target groups	416
CIA recall of December 87	425
CIA, "Talking Rock" experiments	301
CIA, clones and doubles created by	303
CIA, creation of	401,402
CIA, creation of counternarcotics front	428
CIA, implants and mind control used on humans	308
CIA, legalization of covert activities	403
Cigar ships sighted in 1896	397
Clones, creation of by Grey Hierarchy	105A-105D
Cloning of abductees	377A
Cloning of humanoids	202
Clothing hasn't changed in 15,000 years	372
Coexistence of human and alien souls in same body	36
Collection of energy from abductees	148
Colonization of unprotected civilizations	59
Communications monitoring	24
Compartmentalization of information	23
Compulsion to report to implant station	324
Computer thought communications link	105A
Conanda, Henry, work on lenticular craft	399
Conditioning of human body to accept alien soul	35
Conditioning of the human species	10
Condon committee as debunking process	414
Condon report	415
Confederation , the	10,333
Confederation, Draconians members of	98
Connections between brain and conscious focus	349
Conscious human compliance to being used	36
Consciousness and awareness	343
Consciousness and subconsciousness	346
Consciousness, displacement in human bodies	153
Consent, concepts of covert and overt consent	152
Conspiracies, subjective or objective	22
Contact and Abduction	107
Control elements over entities used	321
Cooper, Gordon	413
Cooper, William	431
Cooper-Lear indictment to the President	427
Council of Nicea	374C
Covers and diversionary information	23
Covert penetration and alliance	24
Cow blood used in humans	138
Cranston, Alan, viewing of disks at Norton AFB	426
Crash in Botswana, 1989	80A
Creation and choice of lines of reality	19
Cross breeding with human beings	52
Crystalline Biological Structures	87
Crystals grown in ELF fields	322
Custodial religious programming	374C
Cylinder, breeding	193
D.R.E.A.M.land	234
Damage control problems for MJ-12	8
Darlington farm case in Grudge 13 report	64
DARPA and mind-reading machines	417
DARPA tests with microwaves on Rhesus monkeys	413
Dealing with relationships	363,364

INDEX

DESCRIPTION	PAGE
Death procedures for humans	324
Debriefing colonies for contactees	408
Deception strategies, elements of	28
Decisions, right and wrong	353
Defense Investigative Service probes researchers	428
Defense Resources Act suspends Bill of Rights	422
Definitions, general	365
Delta Security Forces	2
Deposition of human soul from its body	36
Deteriorization of Abductee physicality	121
Determination of blocks to focus expansion	353
Developing a spiritual personality	18
Dharma	13
Dharma writings	14
Differentiation of Prime Entity	356
Direct interference tactics	24
Direct observational procedures, human targets	328
Direct witness as a resource	23
DISCO as world security force	407
Disinformation baiting	24
Disinformation Objectives and Strategies	22
Disinformation, offensive reasons for	22
Disks, firing at, US Army	419
Dismantling counter-beliefs	26
Distribution of Cultures from Lyrae	377
DNA enrichment of alien stock	52
DNA replication research, Cetus Corporation	427
DNA-RNA mixtures	84
Doctrine, "End of the World"; See Mettaya Prophecy	374C
Doctrine, "Judgement Day "; See Mettaya Prophecy	374C
DOE established	419
Doing what you are supposed to do	362
Doll body, alien use and manipulation of, ID	93
Dolphin, brain development of	84, 336
Dolphins and their chosen line of experience	336
Domain of discourse and belief	23
Domination and enslavement of populations	58
Donavon Masters	165
Doorway amnesia	149
Doraty, Judy, case of	212
Doty, Richard	105A-105D
Doty, Richard, AFOSI	2, 105X
Dr. Carl Jung	5
Draco, intentions of	335
Draconians	96, 100D
Draconians left Greys in charge	370
DREAMLAND	410
Dreamland, accidental flights over, results of	419
Drug distribution points, CIA	424
Drug problem, reason why people use drugs	342
Drugs, military shipments of	432
Dulce and John Harrington	205
Dulce area, early studies of	197
Dulce base, narrative about	195
Dulce Papers, description of	189
Dulce, abductee letter about	166
Dulce, appearance of exterior security guards	201
Dulce, conveyor system and work station at	199

INDEX

DESCRIPTION	PAGE
Dulce, cross section view of base	211
Dulce, early activity at	412
Dulce, elevator controls at	196
Dulce, entrances	202
Dulce, hybrid breeding of humanoids	199
Dulce, ID card at	196
Dulce, known activities at	205
Dulce, security uniform description	196
Dulce, the Committee	205
Dulce, typical entity being bred at	198
Dulce, underground explosions at	433
Dulce, levels at	200
Ea , alien responsible for human creation	374A
Earth humans from another time and space	80
Earth humans masquerading as aliens	79
Earth, on trade route	98
Eban, the	2,3,84
EBE	58
EBE disorders	243
Effect on of emotion on hybrid fetus during term	121
Effective measures against Markabian control	370C
Effects of hybrid breeding on humans	121
Effects of Multiple Level Alien Manipulation	120
Eglin AFb, FL	70
Ego, Self and Personality	346
Ego, structures of	346
Ego, transformation of	346
Eisenhower and appointment of Rockefeller	407
Elder race	98
Electronic barrier field	370B
Electronic Identification Research, Los Alamos	421
ELF entrainment of voters before election	425
ELF waves against humans	207
ELF waves influence Bush election	425
Elite, functions of	58
Elohim, the	322
Emotional bodies	364C
Emotional frequencies, used by aliens	148
Emotional growth of aliens	40
Energy grid systems	413
Energy grid transmitters powering implants	321
Enforced identification as control method	370B
Enforced Reality, definition of	368
Engram command, definition of	368
Engram, definition of	365
Entities seen by abductee Christa Tilton	204
Entity displacement, cases of	153
Entity-level karmic scenarios	152
Eoku, aliens known as, discovered by Bennewitz	105A-105E
Esoteric chronology	375
Esoteric history of Lyran Empire	370
Essessani, conversations with	357
Essessani, the	335
ET Event, message about	236
Etheric body	157
Eucharist, ritual of	100D
Events on the moon	398
Evil, definition of	367

INDEX

DESCRIPTION	PAGE
Exam table experiences	148
Experience changing molecular structure of body	364D
Experienced Anomalous Trauma (EAT)	156
Experiencing "victim" scenarios	364D
Experiencing "victimizer" scenarios	364D
Experiencing on a soul level	364D
Experiential memory	131
Exteriorization of an entity, forceful	153
FAA complex in Albuquerque	105D
Facsimile Bank, definition of	366
Facsimile, definition of	366
FBI, asking abductee about sex with aliens	171
FDR and the "gift" of several countries to USSR	370B
FDR as a co-conspirator in planetary terror	370B
FDR, Masonry, and contact with the Greys	399
Fear, use by Secret Government and aliens	45
Federal Emergency Management Agency, creation of	419
FEMA and REX exercises	419
FEMA, creation of	419
Ferraz, Dirant, case of	377A
Fifth density beings, capabilities of	95
Fifth Invader Forces, definition of	368
Fluctuation of Physical Focus	353
Flying saucers and idea of God, reconciliation	262
Flying serpent patch	96
Forced linking	337
Ford, Gerald, call for UFO inquiry in Congress	414
Forrestal, James and Bethesda Naval Hospital	405
Forrestal, James, death of	405
Forrestal, James, suicide of	261
Fort Ord abduction of 221 soldiers	411
Fort Riley, Kansas	70,176
Fort, Charles, investigations of	374A
Four Corners Area, event characteristics of	187A
Fourth density beings, capabilities of	95
Frequency models	162
Frequency models of astral projection	162
Friedman, Stanton	11
Functional relationships in Secret Government	395
Functioning in an alien cultural format	153
Fusion between human and alien souls	35
Game, definition of	366
Games Condition, definition of	369
Games of control	321
Gamma ray laser	302
Gehlen, Reinhard, creation of CIA	401
Gemini capsule, disks following	413
General Dynamics	254
General Gordon Williams	238
Generation of entities from the Prime, drawing	356
Generation of human conflict and wars	374C
Generator, Football sized, nuclear	69
Genes that control growth	391
Genetic entity, definition of	365
Genetic input	121
Genetic materials from humans	34
Genocide as a control measure of alien origin	374E
German experimental craft	400

INDEX

DESCRIPTION	PAGE
German SS intelligence imported for CIA	402
German surveillance of United States in 1933	399
Germans in the USA, 1933	399
Gizah pyramid	15
Gizeh intelligences	12
Glasnost in in Soviet Union	20
Gomez, Ed	195
Government buying time	43
Government Control System Installation	7
Government Duplicated Alien Spacecraft	7
Government explanation of Suppression	43
Government interference with abductee	171
Government secrecy, roots of	342
Government simplification of alien types	43,44
Government staging controlled "landing"	4
Grand Orient Lodge	397
Gravity Anomalies, mass, map of	185
Green fireballs	405
Grey abductees contacted by Blondes later	108
Grey activities	52
Grey anatomical results	67
Grey manipulation, individuals immune to	155
Grey Objectives, General	57
Grey physical structure has left hand spin	56
Grey physiological report	88C
Grey psychological profile	95
Grey Strategies and Operations	58
Grey, anatomical detail of hand	82
Grey, control based on intimidation and tech	90
Greys , military concepts of	54
Greys and concept of bonding	54
Greys and human emotional components	40
Greys and human individuality	54
Greys and Reptilians	89
Greys and sensitivity to radiation	56
Greys as a social memory complex	54,57
Greys as clones in social memory complex	81
Greys as electronic space society	54,85
Greys as go-between communicators	90
Greys as Neutral Aliens	40
Greys having a survival based social order	54
Greys hybrids with active pineal gland	97
Greys opinion of humans	90
Greys using clones for workers	52
Greys, 22 sub-species	102
Greys, 4th density	95
Greys, 4th density as sensation junkies	95
Greys, 5th density	95
Greys, 6th density	95
Greys, ability to contain human awareness	154
Greys, ability to control heart rate	97
Greys, apparent social structure	57
Greys, average weight of	81
Greys, Belletrax types	100A
Greys, bio-field differential effect on humans	119
Greys, brain capacity	81
Greys, brain, crystalline networks in	88B
Greys, cloning and replicative failure	84

DESCRIPTION	PAGE
Greys, Composite Autopsy Findings - Visuals	83
Greys, duty and obedience	57
Greys, first deal with	400
Greys, groups above in hierarchy	105A-105E
Greys, human activity affecting	154
Greys, individuality of	88B
Greys, information from Paul Bennewitz	105A -105E
Greys, internal body structure	88,88A
Greys, lobes of the brain	87,88B
Greys, main motivation for genetic work	54
Greys, Ohroes Dialect of the Crem, Alphabet	80A
Greys, Physiotypical Drawing	91
Greys, primary physical characteristics	81
Greys, process of nourishment	81
Greys, reactions to human children	152
Greys, reproductive capabilities	81
Greys, reproduction processes, cloning	84
Greys, several species of	100A
Greys, skin pigmentation	97
Greys, some species with chlorophyll based system	88C
Greys, some species with normal sexual organs	88B
Greys, species skin tones	81
Greys, summoned by John Dee in 16th century	81
Greys, tall	58
Greys, tall, as "test tube" species	88B
Greys, tall, as dominant over clones	88B
Greys, telepathic	97
Greys, use of cattle biologicals, mutes	84
Greys, use of hydrogen peroxide	81
Greys, use of underground facilities for breeding	84
Greys, visual sensitivities	97
Greys, working for Reptilian species	89
Greys, Zeta Reticulans	100A
Grid systems as implant power sources	413
Gritz, Bo, discussion of CIA and drugs	427
Groom Lake	3,165,245
Groom Lake and Area 51	213
Groom Lake underground base	174
Groom Lake, Air Force seeks restrictions to	214
Groom Lake, hearings on land withdrawal	217,219,223
Groom Lake, Soviet Satellite photo of	233
Groom Lake, topographic of	233
Groom Lake, tunnels and gravity anomalies at	234
Groom Mountains, use for recovered disk testing	403
Group awareness and communications	338
Group Reactive Mind, definition of	368
Group species pool of consciousness	336
Group Theta, definition of	368
Grudge 13 Report	61
Gulf Breeze, analysis of fluid from	425
Gun Control, attempt to take private weapons	429
Halfbreeds, alien creation of	89
Happiness	354
Hardy, Rene, death of	417
Harold Burr, mapping bioelectrical fields	158
Harvest, the	14
Harvesting and the Draconians	98
Harvesting of humans	33

DESCRIPTION	PAGE
Hatonn	10,13,14
HBO	2
Hefferlin manuscript	169
Helicopters, black military	177
Henderson, Gary, General Dynamics, disappeared	263
Hermann, William, abduction of	419
Heroin production in 1949	4
Herr J as walk-in suppressive being	370C
Herrmann, Bill	209
Higher Self as source for all knowledge	364B
Hill, Betty and Barney	1
Hiroshi Motoyama, chakra studies of	160
Historical elements supporting alien interaction	371
Hive-souls	336
Holloman AFB agreement	242
Holloman landing	258
Holloman meeting with aliens	2
Holloman, meeting at	407
Holloman, second meeting at	413
Holographic display, presented to abductee	93
Homo Sapiens, created by alien race	374A
Homo Sapiens, creation of	374A
Homo Sapiens, creation of by Grey Hierarchy	105E
HQ CR44	421
Hu-Men	98
Human aliens in league with malevolent aliens	10
Human appearing aliens, list of	80
Human appearing extraterrestrials	80
Human appearing interdimensionals	80
Human bodies, use for alien souls	35
Human Frequency Spectrum	160
Human Hybridization	34
Human manipulation by aliens, methods	33
Human multidimensional anatomy	157
Human mutilation	1
Human souls in alien bodies	36,38
Human Souls, purpose for subjugation	37
Human souls, use as preemptive alien force	37
Humanity as raw material for species rebirth	12
Humanoid appearing aliens, list of	80
Humanoids and Non-humanoids	79
Humans as slave race	374A
Humans as source of cloning materials	34
Humans as source of emotional energy for aliens	34
Humans as source of mental energy	34
Humans being recycled	95
Humans building ranks of servants	37
Humans implanted as controls	102
Humans over ten feet tall	374
Humans under covert influence from aliens	79
Humans, harvesting of	100C
Hybrid Aliens and Humans	40
Hybrid fetus extraction	121
Hybrid fetus, bio-conditioning of human female	121
Hybrid, female, grey/human, picture of	334
Hynek, Allen, criticism of scientists	414
Hypnosis, nested	147
Hypnotic regression	147

INDEX

DESCRIPTION	PAGE
Hypnotism, definition of	366
Identity and the Self	345
IG Farben backed by USA	398
IGY year , 1958, expeditions to poles	410
Illuminati, Bavarian, founding of	397
Illusion of concept of struggle	364C
Immanuel	10
Immersion of Human subject into target beliefs	26
Immortality, definition of	369
Impact dulling and disinformation	25
Implant Goal, definition of	368
Implant GPM, definition of	368
Implant sites, head, diagram of	325
Implant stations, description of	322
Implant Technology	320
Implant technology, covert government use of	130
Implant technology, purpose of	321
Implant technology, use of by aliens	320
Implant, definition of	368
Implantation of beings as control measure	370A
Implantations, reasons for	337
Implanted Goal, definition of	369
Implanting , humans vs aliens	327
Implants done through CIA	308
Implants, alien, for monitoring	39
Implants, early human CIA type	404
Implants, use in Sweden	414
Implementing new life patterns after brainwash	26
Imposition of alien institutions on Earth	374C
Inca legends of space craft	371
Incubators, alien breeding	206
Inculcation devices	328
Inculcation Light Bar	329
Inculcation monitor	93
Inculcation monitors	329
Inculcation, rapid, processes of	329
Indicators of Alien involvement	122
Individual, definition of	368
Infections gained through abduction	121
Inflatable monetary system and human manipulation	374G
Information control and containment	24
Information destination control and containment	24
Information transfer interception	24
Inner earth entrances	178
Inner guides	364B
Intentions of the 'Benevolent' aliens	12
Interdimensional Association of Free Worlds	333
Interlinks between astral matter and body	163
Internal Duct system	157
Internal Security Act of 1950	415
International Geophysical Year, true purpose of	410
International Monetary Fund	370C
Interplanetary Phenomenon Unit (IPU)	405
Intuition and awareness	351
Invader forces, definition of	368
Invasion tactics	59
Ionized matter bridge	372
Irving, Texas	170

DESCRIPTION	PAGE
Jacobsson as manipulated by suppressive being	370B
James Doolittle	70
Japan bombed by FDR despite surrender	370B
Japanese interned by United States	401
Japanese surrender and use of atomic devices	402
Jehovah beings	374B
Jehovah entities	374B
Jehovah, the	100D
Jesus as a savior	341
Jesus as the "son of God"	374C
Jesus Sananda	10
Jesus, deterioration of concepts taught by	374C
Jesus, origin of	342
Jmmanuel	13
Joy of creation and doing what moves you	361
Judgement, effects of	361
Justice for Military Personnel	425
Kamagol II group	12
Kammler, Hans	402
Kappas as legendary aliens in Japan	373
Kennedy ultimatum to MJ-12	412
Kennedy wanted to tell the public	258
Kennedy, Bilderburgers reaction to	411
Kennedy, threats to go public with UFO data	411
Kennedy, ultimatum to MJ-12	412
Keyhoe, Donald and censorship	411
Kim B. Han, studies on acupuncture systems	157
Kirok project of NAR, alien purposes behind	351
Kirok transcripts	332
Kirtland AFB, NM	262
Kissenger and the JASON group	409
Kissenger as head of alien study group	409
Klass, Phil	11
Krill papers	263
Kugelblitz	401
Kummersdorf, underground facilities at	400
Law of conscious compliance	37
Law of One, the	333
Lazar, degrees and schools attended	255
Lazar, Robert ,interview with	276,280
Lazar, Robert, on Channel 8, commentary by Lear	255
Lazar, Robert, television interview	428
Lazar,Robert and EG&G	300
Lear, John, statement on December 29, 1987	238
Lear, John, statement on November 25, 1989	253
Legal harvesting by aliens	33
Legends of non-human races at war on Earth	371
Lend Lease program	404
Level of doubts reflect degree of separation	364A
Life disruption of witnesses	24
Life extension, public hints in 1985	394
Life form, definition of	367
Life, individual probabilities and choice	343
Light body, the	322
Linda Howe	2,258
Liquid Light Technology	88,321
Livermore Labs, manufacture of artificial blood	424
Lobotomies as control method	404

INDEX

DESCRIPTION	PAGE
Lobotomies intrduced as control method	404
Logic, alien, comments from Bennewitz	105A-105D
Los Alamos	2
Los Alamos National Labs	4
Los Alamos, development of tunnel boring machine	423
Los Angeles police officer killed in 1987	5
Louette, John, mutilation of	2
Love as fundamental energy	349
Love as the fundamental energy of All That Is	349-50
Lucky Luciano	4
Lyrae system	102
MacArthur relieved of command	406
MacDonald, James E	414
MacDonald, James, critical of scientific studies	416
MacDonald, James, mysterious death of	416
Major Keyhoe	5
Makabian implant stations on Earth	322
Malevolent alien purpose and strategy	14
Malevolent aliens and earths religions	12
Malevolent aliens dependence on religion	13
Malevolent manipulation of secret government	18
Malevolent soul-processing hypotheses	30
Man , definition of	365
Manipulation by "apocalypse"	374C
Manipulation by claims of "overpopulation"	370A
Manipulation by claims of "state of emergency"	370A
Manipulation by use of marshal law	370A
Manipulation of belief structures	23
Manipulation of earth humanity	19
Manipulation of mental energy	86
Manipulation through concept of "hell"	374D
Manipulation through concept of "lone assassin"	374D
Manipulation through concept of "sex as sin"	374D
Manipulation through ego defense mechanisms	374D
Manipulation using "reincarnation"	374C
Manipulation using "suffering"	374C
Manipulation using "system of salvation"	374C
Manipulations involving discrete energies	163
Manzano WSA alien activity, report investigating	105V
Map from 13,000 years ago	374
Marcab Confederacy, definition of	366
Marineland, use as genetic research facility	432
Markab system	370B
Markabian forms of societal leverage	370B
Markabian use of sex, pain, and fear	103
Markabians	102
Mars probe link lost by Soviets	427
Mars probe lost, Soviet	427
Mars, space probe landed in 1962	412
Mars, space probe lands on	412
Marxism, philosophy as a control system	374G
Mass colonization of Earth	18
Mass Contact	9
Mass control strategies of aliens	12
Mass psychosurgery introduced	412
MATRIX, the	263
Maury Island incident	408
Mayans, creation beliefs of	374F

INDEX

DESCRIPTION	PAGE
McCarthy, Joseph, death at Bethesda	409
McDill AFB, Florida	70
McDonnell Douglas, new engine technology	424
Media news info release in metered fashion	20
Medicine Wheel in Wyoming	169
Meier	10
Meier transcript translators	11
Meier transcripts, translation of	15
Meithe, designs of	399
Memories, working with conscious	120
Memory and implants	331
Memory and the self	345
Memory block, double	147
Memory Blockage	1
Memory deletion	147
Memory functions in the abductee	147
Memory patterns, injection of copies into body	153
Memory retrieval	147
Memory transfer	153
Memory, associative	331
Memory, holographic reproduction of	153
Memory, non-cognitive	331
Memory-blocked consent	152
Men in Black = USAF Relocation personnel	69
Men in Black and the Plagues	374E
Mental body	162
Mental illness induction	24
Mesopotamia, religions of	374A
MEST Body, definition of	367
Mettaya prophecy	374C
Mexico, sightings and tunnels	176
Microwave effects on nervous systems, research	413
Military industrial complex	137
Mind cages	322
Mind Control experiments in England	414
Mind Control experiments in prisons	409
Mind control experiments on prison inmates	409
Mind control in Warminster England	414
Mind Control, components of	309
Mind Control, interview with CIA employee on	310B
Mind, definition of	369
Minimization of Predictions	17
Mirroring with one another	364B
Missing time among military personnel	69
MJ-12, Controlled release predicament	19
MJ-12, General Mass Contact Axioms	9
MJ-12, Hypothetical Point of View	8
MJ-12, lack of religious countermeasure program	20
MJ-12, Primary Objectives of	8
MKDELTA as CIA Mind Control program	409
MKDELTA mind control projects	409
Mojave desert, camoers hearing ground sounds	168
Monitoring spheres	105B
Monotheism as a control medium	374B
Moon, alien spacecraft on,	415
Moon, craft sighted on	416
Moon, disks flying across	427
Moon, disks flying across, Swedish research on	427

INDEX

DESCRIPTION	PAGE
Moon, far side, photographs of	415
Moon, objects spotted on	416
Moon, outpost on, public announcement of	429
Moore, William	11
Mormonism, beliefs inherent in	374F
Motorola, developments of	426
Mountains of the Moon in Africa	322
Mu and its empire	374
Multi-level involvement of abductees	154
Multiple time-tracks for same abductee	149
Mutations involving change in chromo order	393J
Mutations not involving change in chromo order	393H
Mutilation of John Louette, 1956, NM	65
Mutilation, human, B-52 in Vietnam	415
Mutilations, investigation of	84A
Mutilations, procedure for tissue sections	84B
Mystery object found in chromosomes	210
Mystery schools	374B
Nansen expedition to North Pole	397
NASA, creation of	410
National Reconnaissance Office (NRO)	2
National Security Act	403
National Security Act as unconstitutional	395D
National Security Agency	2
National Security Agency (NSA) creation	406
National Security Council	403
National Security Council, deals with aliens	409
National Security Intelligence Directives NSCID's	395C
National security, use of concept to mislead	395D
Nationalism, use to manipulate the public	395D
Navy, disks flying in 1968	300
Neanderthal man vanished and Homo Sapiens appears	374A
Nellis AEC range	404
Nellis Air Force Base	165
Nelogeny, Oklahoma	176
Network craft, damage to	94
Network, the	333
Nevada US-Alien Facility Breifing	235
Nevada, state map of	232
New age community	20
Nicene Creed	374C
Nickola Tesla and his creative abilities	361
NIH human genome research	425
Non-interference Law Hypothesis	49
Non-interference Law, exceptions	50
Norton AFB, California	292
Norton AFB, Senator Cranston and disk showing	426
Not buying alien manipulations	18
NSC deal with alien forces	409
Nuclear explosion in Pakistan 4,000 years ago	370D
Nuclear explosions in space	412
Obedience to Law process of indoctrination	324
Ohroes Dialect, The Crem, Reticulan Greys	80A
Oklahoma, sightings and tunnels	176
One With the Universe, concept as control idea	368
One World Plan of the aliens	103
Operating Thetan, definition of	367
Operation Canned Meat	400

INDEX	PAGE
DESCRIPTION	PAGE
Operation Canned Meat	400
Operation Crystal Ball	308
Operation Highjump	403
Orange species	85
Orbiting alien objects	407
Organism, definition of	370
Organizational need-to-know	23
Orion aliens	12
Orion based species	86
Orion entities	320
Orion method of hypnosis	410
Orion, reasons for operations on earth	60
Orson Wells broadcast	400
Orwell, George, and book 1948 title change to 1984	405
Ossendowski's views on Agharta	373
Overt control and fear tactics	24
Overt solicitation of humans for experiments	374I
Oxford University studies	393M
Pain and Judgement	359,361,362
Palme, Olaf, authorized implanting prisoners '73	325
Palme, Olaf, permission to use implants	417
Parasitic enegy beings	34
Parkinson Institute, requests for human fetuses	425
Past lives, dimensionality and choice	364A
Pawns controlled by implants	92
Pawns in the Game	92
Pearl Harbor first seen as vulnerable, 1932	399
Perception, definition of	368
Permindex, formation of CIA front	412
Peter Beter reports on Synthetic humanoids	383
Petit, James, case of CIA implant of	308
Phases of Abductee interaction	131
Philadelphia experiment	300
Photographs taken of aliens	69
Photographs, alien	66
Physical focus expansion	353
Pine Gap, installation at	296
Placenta simulators made public, 1965	194
Plan to keep entities attached to bodies	374B
Planet, process of conquering	59
Planetary management by suppressive entities	370A
Platos discourse on Atlanteans (Atlans)	371
Players in the Game	92
Pleiadians	10,12
Plutarch's description of special peoples	372
Plutonium implants	322
Population control	320,374E 374E
Portal vortices, map of	178
Post Abduction Syndrome	140
Pre-Columbian peoples used Venus calendar	372
Predictability of abductees	42
Predictions not occurring	17
Presidential shelter funds, underground bases	411
Prime entity production of forms for experience	344
Prime Thought, definition of	365
Prince of Darkness	374B
Prince of Earth	374B

INDEX

DESCRIPTION	PAGE
Prison planet operations	324
Probabilities and Life	343
Procyon entities	104
Procyonian craft, description off	104
Procyonians	370
Programmed compulsions	324
Project Aquarius	249,411
Project Argus and nuclear detonations in space	410
Project Argus, detonation in 1962	412
Project Argus, detonations in 1958	410
Project Beta	105F
Project Blue Book	62
Project Bluebook existed in 1972	292
Project Bluebook, end of, public declaration	415
Project Excaliber	4,427
Project Gabriel, sonic weapon development	418
Project Gasbuggy	410
Project Grudge	63
Project Plato as NSA project	407
Project Plowshare	410
Project Pounce	408
Project Redlight	69,406,410
Project Sigma	2,407
Project Sign	404
Project Sign established at Wright Field	403
Project Sign transferred to Grudge	404
Project Snowbird	249
Project Snowbird and real role	408
Project Snowbird, 1986 phase of	424
Projection of focus	349
Psionic abilities and crystal based weaponry	320
Psycho-social study of humans reveals aliens	374A
Psychological control strategies	26
Psychology as conceptual control mechanism	321
Psychosis, definition of	368
Purpose of the Kirok project	351
Quantum physics and human expectation	18
Races, main races of humans	374
Rachel Nevada, marker 29 1/2	231
Radio frequencies at installations	230
Rand Corporation	188
Rand Corporation Deep Underground Symposium	411
Rand Corporation depopulation studies	420
Rand Corporation, conferences on Underground	411
Rand Corporation, Deep Underground Construction	197
RAND Corporation, studies of	420
Rapture, the	14
Reaction as being a prime factor	355
Reactions after reading "Communion"	143
Reactions to viewing hybrid children	143
Reactive Mind, definition of	366
Reagan, secretary translator for Eichmann	411
Reality, definition of	367
Records of alien mining operation 4,000 years ago	370D
Recovery Team Alpha	66
Red-haired humanoids	85
Regret, definition of	367
Reich, Wilhelm, cloudburster experiments	408

INDEX

DESCRIPTION	PAGE
Reich, Wilhelm, murder of	408
Reinickendorf underground facilities	400
Relationships, dependent or independent	363
Religion and spiritual blocks	374B
Religion as a control element	321
Religion as control medium	105E
Religion, instituted via Grey Hierarchy	105E
Religion, sex and pain as human control elements	321
Religion, used as block to be overcome	342
Religious programming, beliefs inherent in	374D
Religious programming: "Doctrine"	374D
Religious programming: "Physical Immortality"	374D
Religious programming: "Single Supreme Being"	374D
Religious programming: "Backsliders punished"	374D
Religious programming: "Human suffering plan"	374D
Religious programming: "Reincarnation"	374D
Religious programming: "Salvation Grace of God"	374D
Relocation of colonies	63
Remotely Piloted Vehicles, use by Government	301
Removal of implanted crystals	328
Replacement of human consciousness in the body	134
Reptilian dietary habits	89
Reptilian elite and winged appendages	96
Reptilian Humanoid appearance	88A
Reptilian humanoids	85
Reptilian physiology	96
Reptilian regard for the humans	90
Reptilians as enemies of the Greys	4
Reticulan craft, equipment on board	92
Reticulan direct observance procedures	94
Reticulan Entities	92
Reticulan laerning and teaching techniques	93
Reticulan memory altering drugs	93
Reticulan scientific surveys	92
Reticulan study of human consciousness	92
Reticulan targets of observation	92
Reticulan use of inculcation monitor	93
Reticulan weakened DNA structure	92
Reticulans, direct inculcation procedures	94
Reticulans, use of domination and control	58
Retrieval of dead aliens via implant focussing	56
Revelations	10,20
Revelations, christian religion as '666'	13
REX-78	419
Rex-78 exercises conducted by FEMA	419
REX-82	422
Rex-82 exercises	422
Richard Miller and Solar Cross	15
Ridge response system	93
Ridge Response System, definition of	330
Ridge systems and energy centers	323
Ridge, definition of	367
Rigellians	102
Right and wrong decisions , concepts of	353
Riverton, Wyoming as drug distribution point	5
Robert Lazar	174
Robertson County, Texas, caves at	168
Robertson Panel as disinformation ploy of CIA	407

INDEX

DESCRIPTION	PAGE
Robotoids	383
Rockefeller asked to help with alien problem	407
Roosevelt and Masons	399
Rosenburg, Julius and Ethel	405
Roswell crash	1
Ruppelt, Edward and Project Bluebook	404
Ruppelt, Edward, mysterious death of	411
Ruppelt, Edward, mysterious of	411
Ruppelt, Edward, statement about Germans	409
Samara Sutradhara	372
Samkya as "system of salvation"	374C
Sandia Labs	80A
Sandia, disks taken to, 1950's	405
Sasquatch as inner earth species	99
Sasquatch incidents	168
Satan as a conceptual testing device	342
Satanic entities	10
Scenario of "planetoid moving toward Earth"	395A
Schauberger, Viktor	399
Schirmer, Herbert	209
Schirmer, Herbert, case of	414
Schriever/Miethe disks flown by Germans	401
SDI and Groom Lake	214
SDI program	4,6
Second coming of christ scenario	341
Second coming, true meaning behind	342
Secret Government Contingency Plans	12
Secret societies inteface with Greys	97
Self and internal conflicts	350
Self-Confidence, definition of	368
Semi-physical beings	80
Separate, illusion of being	344
Serpent race	98
Sex and pain as a control element by aliens	321
Sex as sin concept	374C
Sex, definition of	367
Sightings vs Population density, map of	181
Site S-4	174
Sixth density beings, capabilities of	95
Skeletons having flat or pointed heads	371
Slavery, definition of	368
Smith, Wilber, letter about US disk program	405
Social Reversal of Mind Control	310A
Socorro case, samples from	413
Solar Cross	16
Solar Cross Transcripts	15
Somatic Mind, definition of	366
Soul Shearing by Alien Beings	131
Soul-sharing. The Bill and Bob Example	132
Soul-shearing and harvesting	132
Sounds from under the ground	100
Sounds from underground	168
Source credibility damage	24
Source discrediting and subterfuge	25
South African Crash, 1989	80A
Southern California, map of	182
Southern California, military map of	183
Soviet landings in 1989	430

INDEX

DESCRIPTION	PAGE
Soviet sighting, comments by John Lear	259
Soviet Union landings	430
Soviet Union, sightings in	4
Space shuttle and alien contact	428
Space societies, learning techniques of	328
Space societies, teaching techniques of	328
Space, definition of	367
Species interacting, number of	85
Spheres, hovering around investigators at Dulce	197
Spiritual aspects to growth	350
Spiritual component of alien interaction	39
Spiritual deception strategies of aliens	47
Spiritually evolved human aliens	10
Stanford Research Institute, astral body studies	161
Star people	79
Stealth F-117A, first flight of	421
Stealth F-117A, operational basis	422
Stealth program	6
Steel, production 7,000 years ago	372
Stevens, Wendelle	11
Stollman, Gary	303
Stone, Clifford, interfered with Greys	154
Storage locations for alien bodies	70
Strain free molecular translation	63
Strecher Memorandum on AIDS	426
Subconscious, view of	350
Subjugation and control of humans	12
Subterrene, Los Alamos tunnel boring machine	184
Sumerian legends	374A
Sumerians, ancient, records of	374B
Superstition mountains of Arizona	169
Suppressive beings taking human bodies	370B
Supreme Being, nature of	374H
Survival of alien crossbreeds	54
Suspension of Bill of Rights	422
Symbol of the All-seeing Eye	374G
Symbol of the Phoenix	374G
Symbol, Lyran empire	191
Symbol, serpent	209
Symbol, Zeta Reticulans	191
Symbology associated with control elite	374G
Symbols seen underground and on craft	201
Symbols, Breastplates and Logos seen by abductees	53,55
Synchronicity	355,362
Synthetic identification	393
Synthetic lifeforms	207
Synthetic people and replacement of humans	378
Synthetic species creation	393M
Synthetic tissue production	121
Synthetics, manufacture of	393
Systems of religious salvation	374C
Tactics, police state	370A
Targ and Puthoff UCLA studiesss of 1974, chakras	161
Tax systems as control media	370B
Technology trades with aliens	257
Telepathy as blending of mind function	346
Teleportation and Brookhaven labs	400
Television as mass control medium	404

INDEX

DESCRIPTION	PAGE
Teller, Edward, promoter of Project Argus	410
The Beast, common-market computer	418
The Experimenters	7
The Invaders	7
The Observers	7
The Preventers	7
The Rescuers	7
The Scavengers	7
The Teachers and Friends	7
Theta being, definition of	366
Theta clear, definition of	367
Theta Exterior, definition of	369
Theta Perception, definition of	369
Theta Trap, definition of	369
Theta wave entrainment	153
Thomas C., creator of Dulce Papers	188
Thought monitoring	105B
Thought, definition of	365
Three Mile Island, incident predicted year early	419
Three month human pregnancies - Hybrid breeding	115
Thule Group in Germany	95,398
Thuringia, underground facilities at	401
Tiahuanaco as 250,000 years old	372
Tiahuanaco, pictographic writings	371
Time track, definition of	365
Time tracks and doorway amnesia	149
Time vortices	347
Time, definition of	367
Time-shifted magnetic fields	302
Tones, use of to defeat alien control	119
Tongue River Caveee	169
Toppenish Creek	167
Toppenish Ridge, Washington	100
Total Power, definition of	366
Tracking devices for humans	337
Transmitters, early implanted radio devices	404
Truman and the alien problem	406
Truman and the NSA	406
Truman, death of	417
Tubular meridian system	157
Tunnels connecting corporations	414
Tunnels, map of western region	179
Twenty-Nine Palms base	292
Twenty-nine Palms base, map of	295
Tyranny, discussion of	103
U.S. Navy member present during abduction	138
UFO activity, map of	178
UFO bases, map of	178
Ultrasonic weapons in Germany	69
Underground base at 29 Palms	292
Underground base in Washington state	167
Underground bases and aliens	15
Underground bases and way stations, San Gabriels	100
Underground bases and way stations, Texas	100
Underground Bases for Alien Reproduction	174
Underground bases in Iran	297
Underground bases in New Mexico, map of	180
Underground bases, major southwestern bases, map	184

INDEX

DESCRIPTION	PAGE
Underground bases, Northern New Mexico, map of	187
Underground bases, Southern Arizona, map	187
Underground hybrid care facility	208
Underground shelters	3
Underground UFO bases and way stations	168
United States Gravity Anomalies	175
Universal Intelligent Matrix	356
Unknown plants and flowers on Earth	373
US Army Institute of Surgical Research, Texas	308
US assistance to Germany in 1934	401
US Government as largest distributor of drugs	5
Valerie Hunt, UCLA, chakra studies of	160
Vandenburg, Hoyt	404
Vandenburg, Hoyt, destruction of Sign report	404
Vats, humans floating in, seen by abductee	84
Vats, organic mixing, alien underground	190
Vats, piping between	203
Vats, use of	100B
Vivisectioning of alien bodies by the govt	67
Voluntary and Involuntary contact	9
Von Braun, arrival in United States	402
Von Braun, arrival of	402
Walk-ins	134
Walton, Travis	418
Walton, Travis, aliens in case, Bennewitz comment	105D
War of the Worlds, concepts of implanting used in	428
Warren Commission report	413
Weather modification, Soviet research	418
Weishaupt, Adam, and the Illuminati	370B
Whitley Streiber	95
Who's WHO of Aliens Visiting Earth	79
Wilber Smith	405
Wilhelm Reich	408
William Cooper	3,139
William English	62
Withdrawal of copy of experience by aliens	120
Womb, breeding aliens	192
World economic centralization efforts	19
World War III Pre-emption strategy	7
Wormwood	395A
Worry, definition of	368
Wyoming, secret base in	302
Wyoming, tunnels in	169
Wytheville sightings	250
Xenu, suppressive being called	370A
Yakima Indian Reservation	100,167
Yoga as "system of salvation"	374C
Zoroaster and the Mettaya Prophecies	374C
Zoroaster, promoter of apocalyptic thought	374C

THE LEADING EDGE

In April 1991, Nevada Aerial Research Group moved to Washington State and changed its name to Leading Edge Research Group. Since 1988, we have produced over 2,000 pages of research data and material that is issued in the form of a booklet, now called The Leading Edge. The Leading Edge is normally at least 100 pages in length and at least one is produced each month. As of November 1991, the current issue is number 31. Each issue is \$12 postpaid. A Quarterly Catalog is issued in March, June, September and November. The catalog is \$3.50 and is at least 26 pages in length. The Leading Edge supplements what is in MATRIX II and very often augments and supports areas of discussion in the work.

The main areas of discussion and coverage in The Leading Edge are all precedental in nature, and generally cover the following topics:

Consciousness, Awareness and Self-Empowerment
Alien Interaction and Cultural Studies
Human Abduction
Primary and Free Energy Technology
Space and Time Technology
Advanced Communication Systems
Psychotronics and Mind Control
Crystalline Matrix Technology
Genetic Engineering and Development
Overt and Covert Domination and Control Systems
Planetary Power Structures
Radionics
Gravitational Technology
Factors Affecting Social Development
States of Being and Beingness

The goals of Leading Edge are to provide information on current developments which affect all those on, in, and around this planet, investigate and report on factors which affect the social structure, promote an increase in the general mass consciousness, promote universal understanding and evolution, and to further the processes of creation within and in support of the whole Universal Intelligent Matrix of which you are a part.

The main philosophy of Leading Edge Research, formerly Nevada Aerial Research Group, is that all life forms should have the right and opportunity to have an existence which is endowed with the freedom to produce the maximum number of probable lines of reality in an evolving direction, by choice, without repression of awareness or manipulation of physical, mental, or spiritual aspects.

Valerian's first book, THE MATRIX, is reproduced in Leading Edge numbers 23 through 27, available through the catalog. There is also an Update Package available through the catalog for people who purchased the previous two versions of MATRIX II through Arcturus Book Service. Have a wonderful day!